

# ↗ DOMETIC

# CLIMATE CONTROL

# FJX

FJX4233M, FJX4233EEH  
FJX4333E(EH), FJX7333IHP

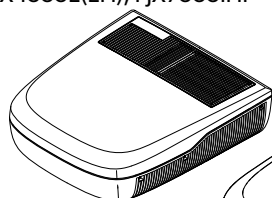

FreshJet FJX7333IHP

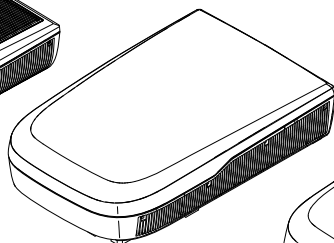

FreshJet FJX7457IHP

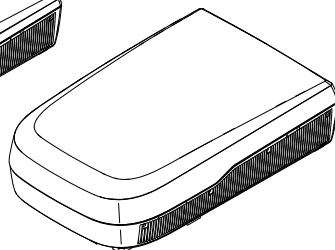

## Domestic FreshJet FJX

<b>EN</b>	<b>Roof Air Conditioner</b> Operating manual.....	3	<b>NO</b>	<b>Takklimalegg</b> Bruksanvisning.....	249
<b>DE</b>	<b>Dachklimaanlage</b> Bedienungsanleitung.....	30	<b>FI</b>	<b>Kattoilmastointilaite</b> Käyttöohje.....	275
<b>FR</b>	<b>Climatiseur de toit</b> Manuel d'utilisation.....	58	<b>RU</b>	<b>Накрышный кондиционер</b> Инструкция по эксплуатации.....	302
<b>ES</b>	<b>Equipo de aire acondicionado de techo</b> Instrucciones de uso.....	85	<b>PL</b>	<b>Klimatyzator dachowy</b> Instrukcja obsługi.....	331
<b>PT</b>	<b>Sistema de ar condicionado de tejadilho</b> Manual de instruções.....	113	<b>SK</b>	<b>Strešná klimatizácia</b> Návod na obsluhu.....	358
<b>IT</b>	<b>Climatizzatore</b> Istruzioni per l'uso.....	141	<b>CS</b>	<b>Střešní klimatizace</b> Návod k obsluze.....	385
<b>NL</b>	<b>Dakairconditioning</b> Gebruiksaanwijzing.....	168	<b>HU</b>	<b>Tetőklíma-berendezés</b> Használati utasítás.....	412
<b>DA</b>	<b>Tagklimalæg</b> Betjeningsvejledning.....	195	<b>AR</b>	439 ..... دليل التشغيل مكيف الهواء على السطح	
<b>SV</b>	<b>Takmonterad klimatanläggning</b> Bruksanvisning.....	222			

## **Copyright**

© 2022 Dometic Group. The visual appearance of the contents of this manual is protected by copyright and design law. The underlying technical design and the products contained herein may be protected by design, patent or be patent pending. The trademarks mentioned in this manual belong to Dometic Sweden AB. All rights are reserved.

## English

1	Important notes.....	3
2	Explanation of symbols.....	3
3	Safety instructions.....	4
4	Intended use.....	5
5	Explanations of symbols on the appliance.....	5
6	Technical limits and conditions.....	6
7	Technical description.....	6
8	Before initial use.....	12
9	Operation.....	12
10	Cleaning the roof air conditioner.....	20
11	Maintenance.....	20
12	Troubleshooting.....	22
13	Disposal.....	25
14	Warranty.....	25
15	Technical data.....	25

## 1 Important notes

Please read these instructions carefully and follow all instructions, guidelines, and warnings included in this product manual in order to ensure that you install, use, and maintain the product properly at all times. These instructions **MUST** stay with this product.

By using the product, you hereby confirm that you have read all instructions, guidelines, and warnings carefully and that you understand and agree to abide by the terms and conditions as set forth herein. You agree to use this product only for the intended purpose and application and in accordance with the instructions, guidelines, and warnings as set forth in this product manual as well as in accordance with all applicable laws and regulations. A failure to read and follow the instructions and warnings set forth herein may result in an injury to yourself and others, damage to your product or damage to other property in the vicinity. This product manual, including the instructions, guidelines, and warnings, and related documentation, may be subject to changes and updates. For up-to-date product information, please visit [documents.dometic.com](http://documents.dometic.com).

## 2 Explanation of symbols



**DANGER!** Indicates a hazardous situation that, if not avoided, will result in death or serious injury.



**WARNING!** Indicates a hazardous situation that, if not avoided, will result in death or serious injury.



**CAUTION!** Indicates a hazardous situation that, if not avoided, could result in minor or moderate injury.



**NOTICE!** Indicates a hazardous situation that, if not avoided, could result in minor or moderate injury.



**Note** Supplementary information for operating the product.

### 3 Safety instructions



**WARNING! Failure to obey these warnings could result in death or serious injury.**

- **Electrical appliances are not toys.** The appliance is not to be used by persons (including children) with reduced physical, sensory or mental capabilities, or lack of experience and knowledge, unless they are under supervision or have been given instruction.
- Children should be supervised to ensure that they do not play with the appliance.
- This appliance can be used by children aged from 8 years and above and persons with reduced physical, sensory or mental capabilities or lack of experience and knowledge if they are under supervision or have been given instruction concerning use of the appliance in a safe way and understand the hazards involved.
- Cleaning shall not be performed by children without supervision.
- Any person who is involved with working on or breaking into a refrigerant circuit should hold a current valid certificate from an industry-accredited assessment authority, which authorises their competence to handle refrigerants safely in accordance with an industry recognised assessment specification.
- Maintenance shall only be performed as recommended by the equipment manufacturer. Maintenance and repair requiring the assistance of other qualified personnel shall be carried out under the supervision of the person competent in the use of flammable refrigerants.
- Repair of the appliance may only be carried out by qualified personnel who are familiar with the risks involved and the relevant regulations. Inadequate repairs may cause serious hazards. For repair service, contact the service center in your country (see [dometic.com/dealer](http://dometic.com/dealer)).
- Always disconnect the power supply when working on the appliance.
- The appliance shall be stored in a room without continuously operating ignition sources such as open flames, an operating gas appliance or an operating electric heater.
- Do not pierce or burn the appliance.
- Be aware that refrigerants may not contain an odor.
- Do not use the appliance near flammable fluids or in closed rooms.
- Ensure that no combustible objects are stored or installed near the air outlet. A distance of at least 50 cm must be kept.
- Keep the ventilation openings clear of obstruction.
- Do not damage the refrigerant circuit.
- Under no circumstances shall potential sources of ignition be used in the searching for or detection of refrigerant leaks. A halide torch (or any other detector using a naked flame) shall not be used.
- The roof air conditioner shall be installed in a vehicle with a floor area larger than 4 m<sup>2</sup>.

**CAUTION! Failure to obey these cautions could result in minor or moderate injury.**

- Do not reach into air outlets or insert any foreign objects in the appliance.
- Do not undo the upper cover of the appliance in the event of a fire. Use approved extinguishing agents instead. Do not use water to extinguish fires.
- If the supply cord is damaged, it must be replaced by the manufacturer, its service agent or similarly qualified personnel in order to avoid a hazard.
- In case that the appliance contains an ionizer, consult your physician if you have a medical condition. The ionizer can produce ozone (O<sub>3</sub>) in small quantities. If you suffer from lung disease, asthma, heart disease, respiratory disease, respiratory problems, or have an ozone sensitivity, consult your physician to determine whether the use of this device is safe for you.

**NOTICE! Damage hazard**

- Do not use means to accelerate the defrosting process or to clean, other than those recommended by the manufacturer.
- The appliance shall be stored so as to prevent mechanical damage from occurring.
- Do not make any alterations or conversions to the appliance.
- Never drive through automatic car washes when the appliance is mounted.
- If faults occur in the refrigerant circuit, the appliance must be checked and repaired by the manufacturer, its service agent or similarly qualified personnel in order to avoid a hazard.

## 4 Intended use

The roof air conditioner FreshJet FJX is only designed for installation on the roof of a caravan or recreational vehicle to provide cooling.

The roof air conditioner is **not** suitable for trains, houses and apartments. The roof air conditioner is **not** suitable for installation in construction machines, agricultural machines or similar equipment.

This product is only suitable for the intended purpose and application in accordance with these instructions.

This manual provides information that is necessary for proper installation and/or operation of the product. Poor installation and/or improper operating or maintenance will result in unsatisfactory performance and a possible failure.

The manufacturer accepts no liability for any injury or damage to the product resulting from:

- Incorrect assembly or connection, including excess voltage
- Incorrect maintenance or use of spare parts other than original spare parts provided by the manufacturer
- Alterations to the product without express permission from the manufacturer
- Use for purposes other than those described in this manual

Dometic reserves the right to change product appearance and product specifications.

## 5 Explanations of symbols on the appliance



Warning! Low burning velocity material.



Read operating manual.



Read service manual.

## 6 Technical limits and conditions

The roof air conditioner is intended for vehicles with roofs with a thickness of 25 mm ... 60 mm. The function of the roof air conditioner is guaranteed for ambient temperatures between  $-2^{\circ}\text{C}$  ...  $52^{\circ}\text{C}$ . The roof air conditioner is designed to be installed within  $\pm 10^{\circ}$  of the horizontal plane. The performance of the roof air conditioner may be reduced when it is exposed to strong vibrations, for example caused by bad road conditions.

## 7 Technical description

The roof air conditioner FreshJet FJX4233M supplies the vehicle's interior with cool air which is without dust and dirt and can be dehumidified.

The roof air conditioner FreshJet FJX4233EEH/FJX4333E(EH)/FJX7333IHP/FJX7337IHP/FJX7457IHP supplies the vehicle's interior with cool or warm air which is without dust and dirt and can be dehumidified.

The roof air conditioner can lower the temperature within the vehicle to a certain level that depends on the type of vehicle, the ambient temperature and the cooling capacity of the roof air conditioner. Below an outer temperature of  $16^{\circ}\text{C}$  the roof air conditioner does not cool anymore.

The roof air conditioner is operated with the following operating elements:

- Control panel

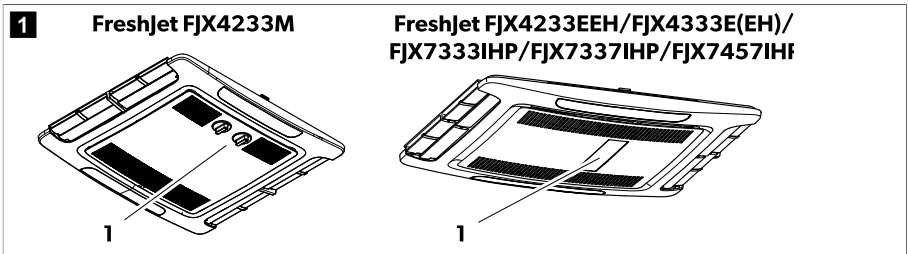

- Remote control (only FJX4233EEH/FJX4333E(EH)/FJX7333IHP/FJX7337IHP/FJX7457IHP)

### 7.1 List of models

The following table shows which function applies to a specific model:

- Feature is available

○ Feature is upgradable

	FJX4233M	FJX4233EEH	FJX4333EEH	FJX4333E	FJX7333IHP	FJX7337IHP	FJX7457IHP
Automatic		●	●	●	●	●	●
Cooling	●	●	●	●	●	●	●
Heating		●	●	○	●	●	●
Ventilation	●	●	●	●	●	●	●
Dehumidification		●	●	●	●	●	●
Air purifier	○	●	●	○	●	●	●
ADB light		●	●	○	●	●	●
External light					●	●	●
Timer		●	●	●	●	●	●
Sleep		●	●	●	●	●	●
Soft start			●	○	●	●	●

## 7.2 Control panel FreshJet FJX4233M

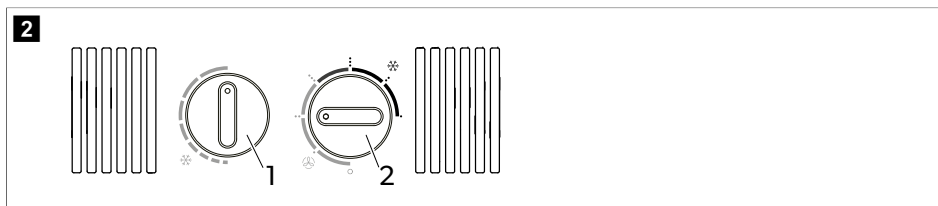

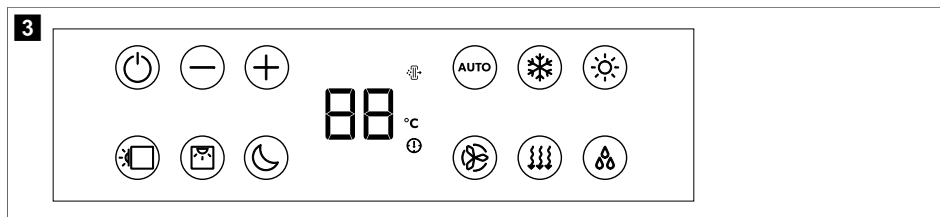

Knob	Description
	Selects the temperature. Turn clockwise for higher cooling.
	Switches the roof air conditioner on or off and selects the intensity of the air circulation in the Ventilation (🌀) mode or the cooling intensity in the Cooling (❄️) mode.

### 7.3 Control panel FreshJet FJX4233EEH/FJX4333E(EH)/FJX7333IHP/FJX7337IHP/FJX7457IHP



Symbol	Description
	Switches the roof air conditioner on or to standby mode.
	Increases the currently displayed value.
	Reduces the currently displayed value.
	Pairs with bluetooth/WLAN when both buttons are pressed simultaneously.
	Switches the ambient lights in the roof top unit on or off.
	Switches the ambient lights in the air distribution box on or off.
	Activates the sleep function (Additional functions (only FJX4233EEH/FJX4333E(EH)/FJX7333IHP/FJX7337IHP/FJX7457IHP) on page 11).
	Displays the set temperature and indicates fan level when fan is adjusted.
	Indicates the AirPurifier mode is active.
	Indicates the temperature is displayed in degrees Celsius.
	Indicates the timer is set.
	Enables/disables the automatic mode (Air conditioning modes (only FJX4233EEH/FJX4333E(EH)/FJX7333IHP/FJX7337IHP/FJX7457IHP) on page 11).
	Enables/disables the cooling mode (Air conditioning modes (only FJX4233EEH/FJX4333E(EH)/FJX7333IHP/FJX7337IHP/FJX7457IHP) on page 11).
	Enables/disables the heating mode (Air conditioning modes (only FJX4233EEH/FJX4333E(EH)/FJX7333IHP/FJX7337IHP/FJX7457IHP) on page 11).
	Adjusts the fan speed between Low, Med, High, Turbo or Auto (shown as 1, 2, 3, 4 or AA on the air distribution box display for a short time when changed).



















Symbol	Description
	Enables/disables ventilation mode (Air conditioning modes (only FJX4233EEH/FJX4333E(EH)/FJX7333IHP/FJX7337IHP/FJX7457IHP) on page 11). Circulates air without heating or cooling.
	Enables/disables dehumidification mode (Air conditioning modes (only FJX4233EEH/FJX4333E(EH)/FJX7333IHP/FJX7337IHP/FJX7457IHP) on page 11).

## 7.4 Remote control FreshJet FJX4233EEH/FJX4333E(EH)/FJX7333IHP/FJX7337IHP/FJX7457IHP





Control and display elements fig. **4** on page 9:

Button	Description
—	<p><b>Display</b></p> <p>Displays the following:</p> <ul style="list-style-type: none"> <li>• Time</li> <li>• Selected room temperature (target value) in °C</li> <li>• Actual room temperature</li> <li>• Air conditioning mode</li> <li>• Fan speed</li> <li>• Symbols for active additional functions</li> <li>• Battery status</li> </ul>
	Switches the roof air conditioner on or to stand-by mode.
	Increases the currently displayed value.
	Reduces the currently displayed value.
	Selects the fan speed (Selecting the fan speed manually on page 15).
	Selects the air conditioning mode (Air conditioning modes (only FJX4233EEH/FJX4333E(EH)/FJX7333IHP/FJX7337IHP/FJX7457IHP) on page 11). The corresponding symbol is displayed.
	Activates the sleep function (Additional functions (only FJX4233EEH/FJX4333E(EH)/FJX7333IHP/FJX7337IHP/FJX7457IHP) on page 11). The  symbol is displayed.
	Confirms and saves settings.
	Sets the timer and the clock.
	Switches the ambient lights in the air distribution box on or off.
	<p>Press once to display the current interior temperature. The  symbol is displayed.</p> <p>Press twice to display the set temperature.</p>
	<p>Activates the I feel function. The  symbol is displayed.</p> <p>Every 10 min the I feel function adjusts the target temperature to the actual temperature measured by the remote control.</p>
	Switches the ambient lights in the roof top unit on or off.
	Displays that the remote control's batteries are empty. Replace the batteries (Replacing the remote control batteries on page 18).
	Displays that the remote control is transmitting values to the roof air conditioner.





## 7.5 Air conditioning modes (only FJX4233M)

The roof air conditioner has the following air conditioning modes:

Air conditioning mode	Displayed symbol	Description
Cooling		You specify the temperature and fan settings, and the roof air conditioner cools the interior to this temperature.
Ventilation		You specify the fan settings, and the roof air conditioner circulates air without heating or cooling.





## 7.6 Air conditioning modes (only FJX4233EEH/FJX4333E(EH)/FJX7333IHP/FJX7337IHP/FJX7457IHP)

The roof air conditioner has the following air conditioning modes:

Air conditioning mode	Displayed symbol	Description
Automatic	<b>A</b>	You specify the temperature, and the roof air conditioner brings the interior to this temperature by heating or cooling and by controlling the necessary fan speed.
Cooling		You specify the temperature and fan settings, and the roof air conditioner cools the interior to this temperature.
Heating		<b>Not FJX4333E:</b> You specify the temperature and fan settings, and the roof air conditioner heats the interior to this temperature. The fan will only start after 2 min (on Low speed) and then after around 5 min will go to the set fan speed (after the evaporator reaches temperature).
Ventilation		You specify the fan settings, and the roof air conditioner circulates air without heating or cooling.
Dehumidifying		The roof air conditioner removes moisture from the air without heating or cooling the interior thus decreasing the relative air humidity.
Air purifier		<b>Not FJX4333E:</b> The roof air conditioner ionizes the air, thus collecting dust and particles including to viruses and bacteria out of the air.

## 7.7 Additional functions (only FJX4233EEH/FJX4333E(EH)/FJX7333IHP/FJX7337IHP/FJX7457IHP)

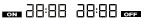
The roof air conditioner has the following additional functions:

Additional function	Display message	Description
Timer		The roof air conditioner is switched on at the specified time.
		The roof air conditioner is switched off at the specified time.
		The roof air conditioner is switched on and off at the specified times.
Sleep		The sleep function reduces the fan speed and the compressor speed to reduce the noise levels for comfortable sleeping.
I Feel		The remote control measures the room temperature and transmits this measurement to the roof air conditioner every 10 min. The roof air conditioner adapts the target value to this measurement.
Soft start		<b>Not FJX4233EEH:</b> The peak current that the compressor start produces is reduced by the soft start function. If a generator is used as power supply, the generator will not be overloaded.

## 8 Before initial use

### Inspection before starting up

Before switching on the roof air conditioner, observe the following:

1. Check whether the supply voltage and frequency correspond to the values specified in Technical data on page 25.
2. Ensure that both the air intake openings and the air nozzles are free. All ventilation grilles must always be kept free to ensure that the roof air conditioner is able to operate at maximum capacity.

### Prepare the remote control (only FreshJet FJX4233EEH/FJX4333E(EH)/FJX7333IHP/FJX7337IHP/FJX7457IHP)

3. Insert the batteries (Replacing the remote control batteries on page 18).

### Set the time (only FreshJet FJX4233EEH/FJX4333E(EH)/FJX7333IHP/FJX7337IHP/FJX7457IHP)

4. Set the current time (Setting the current time on page 15).

## 9 Operation

### 9.1 Hints for improved use

The following hints will optimize the performance of your roof air conditioner:

- Improve the heat insulation of your vehicle by sealing gaps and hanging reflective blinds or curtains on your windows.
- Select an appropriate temperature and fan speed.
- Align the air nozzles sensibly.
- Ensure that the air nozzles and air intake openings are not covered by cloths, paper or other objects.

- **Only FreshJet FJX4233EEH/FJX4333E(EH)/FJX7333IHP/FJX7337IHP/FJX7457IHP:** If the vehicle has been subjected to direct sunlight for a long time: Operate the roof air conditioner in the Ventilation (🌀) mode with the windows open for a while before switching on the Cooling (❄️) mode.
- **Only FreshJet FJX4233EEH/FJX4333E(EH)/FJX7333IHP/FJX7337IHP/FJX7457IHP:** Avoid opening doors and windows as far as possible in the Cooling (❄️) mode.

## 9.2 Basic notes on operation

The FreshJet FJX4233M roof air conditioner has three operating modes:

Operating mode	Description
Off	The roof air conditioner is switched off.
Cooling	The roof air conditioner cools the interior.
Ventilation	The roof air conditioner circulates air without cooling.

The FreshJet FJX4233EEH/FJX4333E(EH)/FJX7333IHP/FJX7337IHP/FJX7457IHP roof air conditioner has two operating modes:

Operating mode	Description
Standby	The roof air conditioner is ready for operation and can be switched on with the remote control. The ambient lights are available. The remote control is also in standby, but you can switch the remote control on independently from the roof air conditioner.
On	The roof air conditioner is conditioning the air in the interior.

## 9.3 Dometic FJX4233M roof air conditioner

The given information in this chapter applies only to the FJX4233M roof air conditioners.

### 9.3.1 Switching the roof air conditioner on and off

The roof air conditioner has two air conditioning modes:





- Ventilation (🌀) mode
- Cooling (❄️) mode



**Note** Before you switch from Ventilation mode to Cooling mode or vice versa, wait for at least 30 s. Otherwise the switching current may blow the fuse.

Each mode has three settings:

- ..: Low
- ...: Medium
- ...: High

- > To switch on, turn the  knob to the Ventilation () mode position or the the Cooling () mode position and choose the desired setting.
- ✓ The roof air conditioner is switched on and operates with the values that were set before switching off.
- > To switch off, turn the  knob to position 0.

### 9.3.2 Setting the temperature

- > Turn the  knob into the desired position. Turning the knob clockwise means a cooler temperature.
- ✓ The temperature is set on the roof air conditioner.

## 9.4 Dometic FJX4233EEH/FJX4333E(EH)/FJX7333IHP/FJX7337IHP/FJX7457IHP roof air conditioners

The given information in this chapter applies only to the FreshJet FJX4233EEH/FJX4333E(EH)/FJX7333IHP/FJX7337IHP/FJX7457IHP roof air conditioners.

### 9.4.1 Using the remote control

Consider the following hints when using the remote control:

- Point the remote control at the IR receiver of the control panel.
- The corresponding settings and values are directly transmitted to the roof air conditioner when you press a button.
- The roof air conditioner confirms the receipt of data with a beep sound.
- Values increase or decrease faster when you press and hold the + or – button.
- In the standby mode, the remote control display is inactive too. You can switch the remote control on to standby independently from the roof air conditioner.
- > To switch only the remote control to or from standby, press the  button while not pointing to the control panel's IR receiver.

### 9.4.2 Switching the roof air conditioner on and to standby

 **Note** When the roof air conditioner is switched on, it operates with the values that were set before switching to standby. The roof air conditioner can be switched off only by cutting the power supply.





- > Press the  button on the remote control or the  button on the control panel to switch the roof air conditioner on or to standby.

### 9.4.3 Selecting the air conditioning mode

- > Select the desired air conditioning mode using the MODE button (Air conditioning modes (only FJX4233EEH/FJX4333E(EH)/FJX7333IHP/FJX7337IHP/FJX7457IHP) on page 11).
- ✓ The roof air conditioner confirms the receipt of the values with a beep sound. The roof air conditioner is switched to the selected air conditioning mode.

### 9.4.4 Selecting the fan speed manually

In all modes, except for the Automatic (A) and Dehumidifying (D) modes, the fan speed can be selected manually.

Display message	Description
	Low fan level
	Medium fan level
	High fan level.
	Turbo fan level.
	Automatic mode (the fan speed is adjusted based on the ambient temperature).

- > Press the  button of the remote control or the  button of the control panel to select the desired fan speed.
- ✓ The roof air conditioner confirms the receipt of the values with a beep sound.

The new fan speed is set.

### 9.4.5 Setting the temperature

In the Automatic (A), Cooling (\*), Heating (☀) and Dehumidifying (D) modes, you can specify a temperature between 16 °C and 31 °C.

- > Use the + or – button on the remote control to set the desired temperature.
- ✓ The roof air conditioner confirms the receipt of the values with a high note. The temperature is set on the roof air conditioner.

### 9.4.6 Setting the current time

The remote control needs the current time in order to program the timer. The time is shown on the remote control display.

1. Press and hold the  button in order to get into the mode for setting the time.
  - ✓ The time flashes on the remote control display.
2. Use the + or – button to set the current time. Press and hold the + or – button longer than 2 s to increase or decrease the time quicker.
3. Press the SET button to confirm the time.















### 9.4.7 Setting the timer

The timer function allows you to set a specific time period for air conditioning. You can specify the switch-on time, the switch-to-standby time or both values.

The timer function is set via remote control.



**Note** The remote control returns to its initial mode if no button is pressed on the remote control for 15 s while programming the timer.

- > Set the **switch-on timer** as follows:
  - a) Select the desired air conditioning mode and all required values (for example the temperature).
  - b) If necessary, switch the roof air conditioner to standby.  
The switch-on timer can only be set when the roof air conditioner is in **standby**.
  - c) Press the  button one time.
  - ✓ The  symbol flashes on the remote control display.
  - d) Use the + or – button to set the time when the roof air conditioner shall be switched on.
  - e) Press the  button.  
The switch-on timer is set. The roof air conditioner will be switched on with the selected air conditioning mode at the specified time.
- > Set the **switch-to-standby timer** as follows:
  - a) If necessary, switch the roof air conditioner on.  
The switch-to-standby timer can only be set when the roof air conditioner is switched **on**.
  - b) Press the  button twice.
  - ✓ The  symbol flashes on the remote control display.
  - c) Use the + or – button to set the time when the roof air conditioner shall be switched to standby.
  - d) Press the  button.  
The switch-to-standby timer is set. The roof air conditioner will be switched to standby at the specified time.
- > Set the **switch-on timer** and the **switch-to-standby timer** as follows:
  - a) Select the desired air conditioning mode and all required values (for example the temperature).
  - b) Press the  button three times.
  - ✓ The   symbol is shown on the remote control display. The ON symbol flashes.
  - c) Use the + or – button to set the time when the roof air conditioner shall be switched on.
  - d) Press the  button.
  - ✓ The **OFF** symbol flashes.
  - e) Use the + or – button to set the time when the roof air conditioner shall be switched to standby.
  - f) Press the  button.  
✓ The switch-on and switch-to-standby times are set. The roof air conditioner will be switched on for the specified time period.
- > To **cancel** preset timer, press the  button once.
- ✓ The   symbols disappear. Preset values are discarded.







### 9.4.8 Setting the sleep function

The sleep function is only available in Cooling (❄️) or Heating (🔥) modes.

The sleep function limits the fan speed to a lower level to reduce the noise levels for easier sleeping.

**Only FJX7333IHP/FJX7337IHP/FJX7457IHP:** The sleep function additionally limits the compressor speed.



- > To activate the sleep function proceed as follows:
  - a) Set the required temperature (Setting the temperature on page 15).
  - b) Press the  button on the remote control or the  button on the control panel.
- ✓ The symbol  appears in the remote control display. The sleep function is activated.
  - > To deactivate the sleep function, press the  or the  button on the remote control or the  button on the control panel.
- ✓ The symbol  disappears in the remote control display. The sleep function is deactivated.

### 9.4.9 Activating the I feel function

When this function is active, the remote control measures the room temperature and transmits this measurement to the roof air conditioner every 10 minutes. The roof air conditioner adapts the target value to this measurement. The I feel function is only active when the temperature range is between +18 °C and +29 °C.

The remote control should not be kept in a part of the room that is considerably warmer or colder than the average room temperature. It may not, for example, be left in the sun or in front of the roof air conditioner.

When the temperature rises above +29 °C or falls below +18 °C, the I feel function is deactivated. The  symbol flashes three times in the display and then turns off.

1. Press the button.
- ✓ The I feel function is activated.

The  symbol appears in the display.

2. Position the remote control so that it points at the IR receiver on the control panel. Otherwise, the values cannot be transmitted to the roof air conditioner.







### 9.4.10 Operating the ambient lights



**WARNING! Risk of injury** By law it is forbidden to use the external lights when driving the vehicle.

The  button on the remote control is active even if the the remote control is switched off.

#### Only FreshJet FJX4233EEH/FJX4333E(EH)/FJX7333IHP/FJX7337IHP/FJX7457IHP:

- > To switch the internal lights on or off press the  button on the remote control or on the control panel.
- ✓ The  symbol flashes once in the display of the remote control when the internal lights are switched **on**.
- > To dim the internal lights proceed as follows:
  - a) Press the  button on the remote control or on the control panel for 3 s.
  - b) When pressing the  button on the remote control: Press the  button to dim the internal light between 50 % and 100 %.
  - c) When pressing the  button on the control panel: The internal light's brightness cycles between 50 % and 100 %. Release the  button when the the desired brightness is reached.

#### Only FreshJet FJX7333IHP/FJX7337IHP/FJX7457IHP:

- > To switch the external lights on or off press the  button on the control panel.

## 9.4.11 Replacing the remote control batteries



**Note** The remote control display may still be bright even if the batteries are running low. Replace the batteries when the remote control indicates low batteries.

- > Replace the batteries as shown.

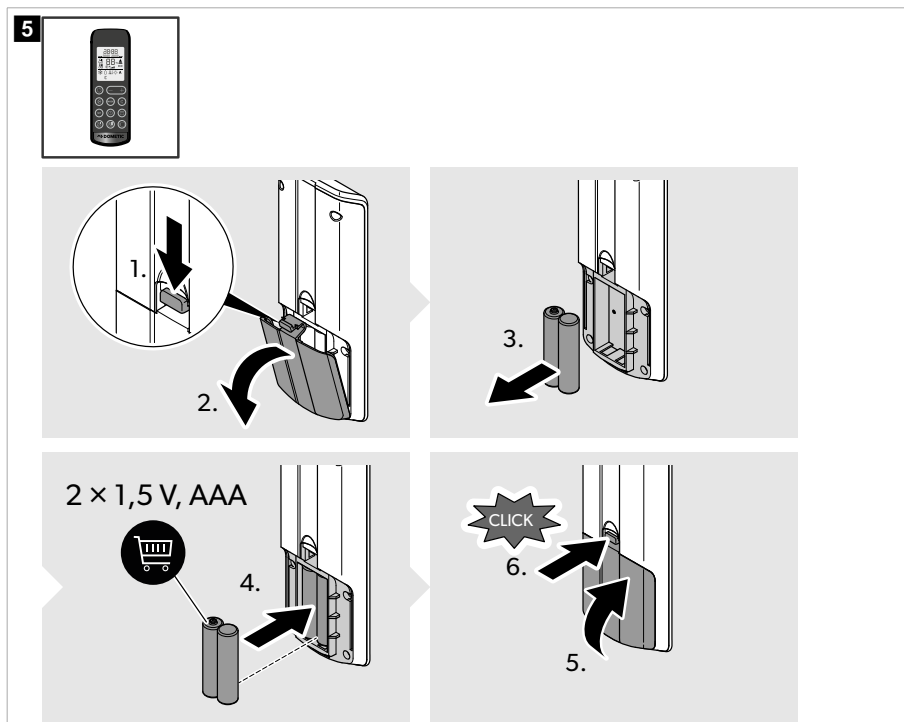

- ✓ The display shows all symbols for 5 s.



Protect the environment! Do not dispose of any batteries with general household waste. Return defective or used batteries to your retailer or dispose of them at collection points.

## 9.5 Regulating air supply within the vehicle

The air flow can be adjusted along the ceiling or towards the floor.

- > Turn the slats in the air nozzles independently in the required directions.

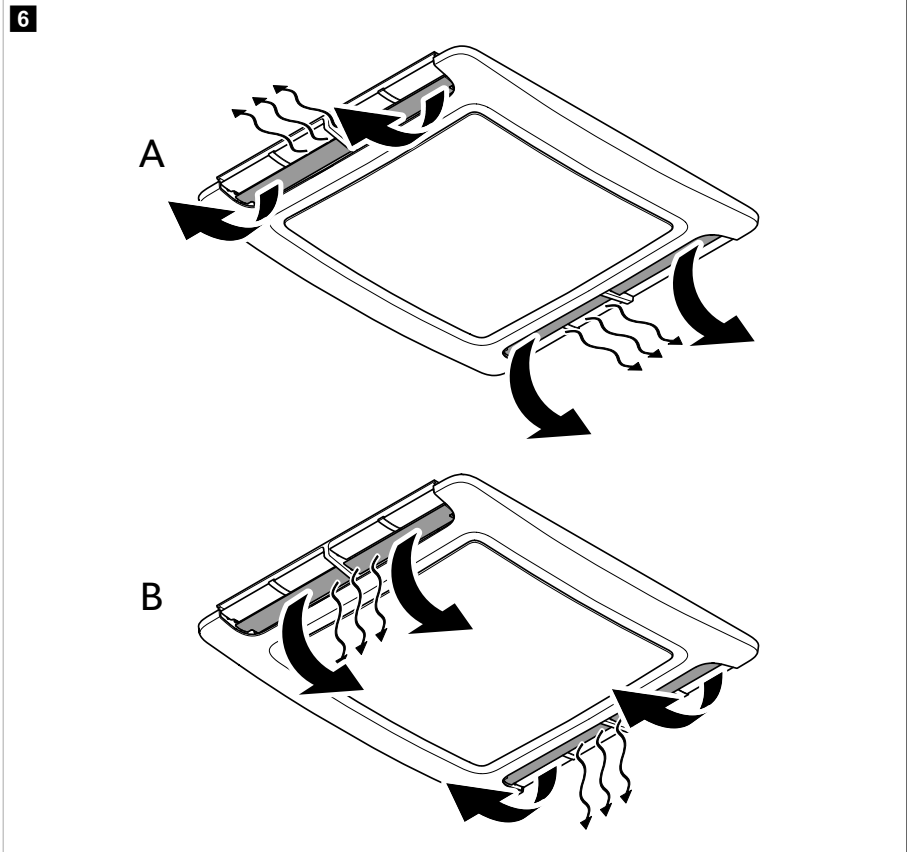

## 10 Cleaning the roof air conditioner



### NOTICE! Damage hazard

- Do not use means to accelerate the defrosting process or to clean, other than those recommended by the manufacturer.
- Do not clean the roof air conditioner with a high-pressure cleaner. Exposure to water can damage the roof air conditioner.
- Do not use sharp or hard objects or cleaning agents for cleaning as these may damage the roof air conditioner.
- Do not use petrol, diesel or solvents.

1. Regularly remove leaves and other dirt from the air intake and the ventilation grilles of the roof air conditioner. Do not damage the ventilation grilles in the process.

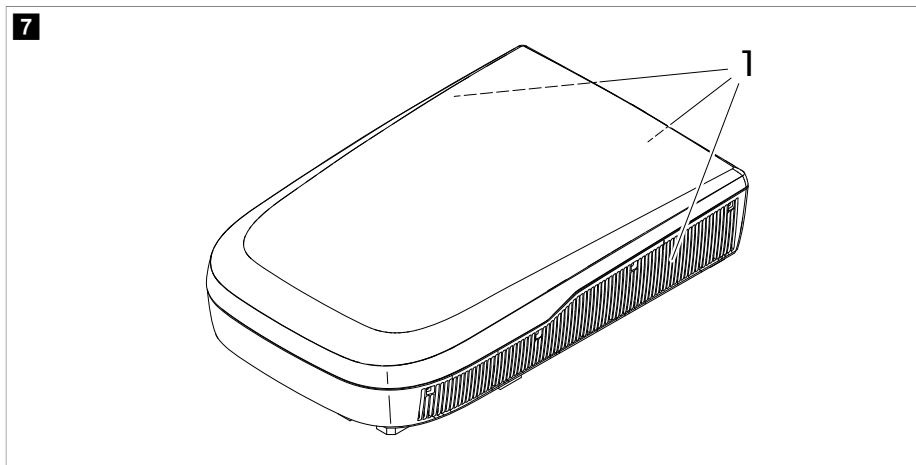

2. Occasionally clean the housings of the roof top unit and the air distribution box with a damp cloth. Use only water with a gentle cleaning agent.
3. **Only FreshJet FJX4233EEH/FJX4333E(EH)/FJX7333IHP/FJX7337IHP/FJX7457IHP:** Occasionally clean the remote control with a slightly damp cloth. Clean the display with a cleaning cloth for glasses.
4. **Only FreshJet FJX4233EEH/FJX4333E(EH)/FJX7333IHP/FJX7337IHP/FJX7457IHP** Occasionally clean the air distribution box display with a mild solution of warm soapy water. The display screen is acrylic and can be damaged by some common household chemicals such as chemical cleaners, window cleaners, alcohol, certain tensides, organic solvents, and softeners.

## 11 Maintenance

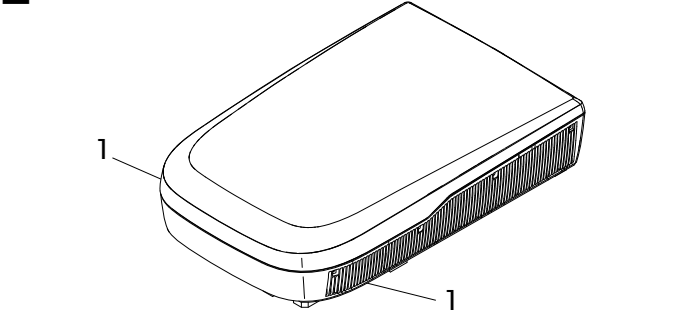
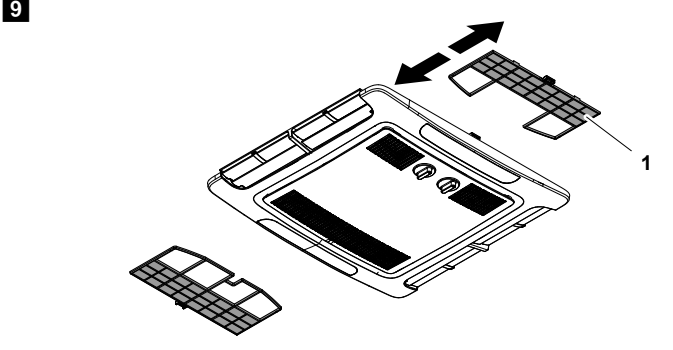

**WARNING! Risk of injury** Any other maintenance work in addition to the described subjects here may only be carried out by qualified personnel who are familiar with the risks involved when handling refrigerant and air conditioning systems as well as the relevant regulations.

Interval	Inspection/maintenance
Regularly	<p data-bbox="333 188 1014 231">Check whether the condensation water drainage channels (1) at the sides of the roof air conditioner are clear and the condensation water is able to escape.</p> <div data-bbox="333 247 1014 614"><p data-bbox="341 252 367 284"><b>8</b></p></div>
Regularly (FreshJet FJX4233M)	<p data-bbox="333 643 620 667">Clean the filter of the air discharge unit.</p> <div data-bbox="333 683 1014 1045"><p data-bbox="341 687 367 719"><b>9</b></p></div> <ol data-bbox="348 1061 784 1125" style="list-style-type: none"><li>1. Remove the filter (1).</li><li>2. Clean the filter (1) with a detergent solution and let it dry.</li><li>3. Put the dry filter (1) back in.</li></ol>

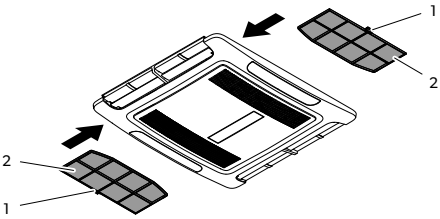
Interval	Inspection/maintenance
Regularly (FreshJet FJX4233EEH/FJX4333E(E-H)/FJX7333IHP/FJX7337IHP/FJX7457IHP)	<ul style="list-style-type: none"> <li>Clean the filter of the air discharge unit.</li> </ul> <div data-bbox="367 225 1016 528" style="border: 1px solid black; padding: 10px; margin: 10px 0;"> <p><b>10</b></p>  <ol style="list-style-type: none"> <li>1. Insert a flat screwdriver or knife into the handle (1) to pull the filters (2) slightly out.</li> <li>2. Remove the filters by hand.</li> <li>3. Clean the filters with a detergent solution and let them dry.</li> <li>4. Slide the dry filters back in. <a href="#">fig. 10</a> on page 22</li> </ol> </div> <ul style="list-style-type: none"> <li>Have the heat exchanger of the roof air conditioner serviced by specialist company.</li> </ul>
Once per year	<ul style="list-style-type: none"> <li>Check the seals between the roof air conditioner and the vehicle roof for cracks and other damage.</li> <li>Check whether the fastening bolts are tightened to the correct torque (2.5 Nm <math>\pm</math> 0.3 Nm) and adjust if necessary.</li> </ul>

## 12 Troubleshooting

Problem	Possible cause	Suggested remedy
Not cooling well	The roof air conditioner is not set to cooling.	Set the roof air conditioner to cooling.
	The ambient temperature is above 52 °C.	The roof air conditioner is only designed for ambient temperatures of up to 52 °C.
	The temperature set is higher than the room temperature.	Select a lower temperature.
	The ambient temperature is below 16 °C.	The roof air conditioner is designed for cooling only at ambient temperatures above 16 °C.
	One of the temperature sensors is defective.	Contact an authorized service agent or Dometic.
	The evaporator fan is damaged.	Contact an authorized service agent or Dometic.
	The condenser fan is damaged.	Contact an authorized service agent or Dometic.

Problem	Possible cause	Suggested remedy
<b>Only FreshJet FJX4233EEH/ FJX4333E(EH)/FJX7333IHP/ FJX7337IHP/FJX7457IHP:</b> Not heating well	The roof air conditioner is not set to heating.	Set the roof air conditioner to heating.
	The ambient temperature is below – 2 °C.	The roof air conditioner is designed for ambient temperatures above – 2 °C.
	The temperature set is lower than the room temperature.	Select a higher temperature.
	One of the temperature sensors is defective.	Contact an authorized service agent or Dometic.
	The evaporator fan is damaged.	Contact an authorized service agent or Dometic.
Low Air output	The air intake openings are blocked or obstructed.	Remove any leaves and other dirt from the ventilation grilles of the roof air conditioner.
	The fan is defective.	Contact an authorized service agent or Dometic.
Water enters the vehicle.	The condensation water drainage openings are clogged up.	Clean the water drainage openings from condensation water.
	The seals are damaged.	Contact an authorized service agent or Dometic.
The roof air conditioner does not switch on.	No power supply connected.	Check the power supply.
	The voltage is too low (< 200 V).	Contact an authorized service agent or Dometic.
	The voltage converter is defective.	Contact an authorized service agent or Dometic.
	One of the temperature sensors is defective.	Contact an authorized service agent or Dometic.
	The electrical fuse of the power supply is too low.	Contact an authorized service agent or Dometic.
The roof air conditioner does not switch off.	One of the temperature sensors is defective.	Contact an authorized service agent or Dometic.
	The electrical fuse of the power supply is too low.	Contact an authorized service agent or Dometic.
<b>Only FreshJet FJX4233EEH/ FJX4333E(EH)/FJX7333IHP/ FJX7337IHP/FJX7457IHP:</b> The roof air conditioner constantly switches itself off.	The icing sensor has tripped.	The outer temperature is too low or all air nozzles are closed.
The display shows: PO	Over temperature or over current on IPM module	Contact an authorized service agent or Dometic.

<b>Problem</b>	<b>Possible cause</b>	<b>Suggested remedy</b>
The display shows: P1	Under voltage protection	Contact an authorized service agent or Dometic.
The display shows: P2	Unit AC over-current protection	Contact an authorized service agent or Dometic.
The display shows: P4	Discharge tube overheat protection	Contact an authorized service agent or Dometic.
The display shows: P5	Evaporator coil protection (cooling mode)	Contact an authorized service agent or Dometic.
The display shows: P6	Condenser coil protection (cooling mode)	Contact an authorized service agent or Dometic.
The display shows: P7	Evaporator coil protection (heating mode)	Contact an authorized service agent or Dometic.
The display shows: P9	Compressor drive abnormal or compressor does not start	Contact an authorized service agent or Dometic.
The display shows: E0	Communication failure	Contact an authorized service agent or Dometic.
The display shows: E1	Room temperature sensor fault	Contact an authorized service agent or Dometic.
The display shows: E2	Evaporator coil temperature sensor fault	Contact an authorized service agent or Dometic.
The display shows: E3	Condenser coil temperature sensor fault	Contact an authorized service agent or Dometic.
The display shows: E7	Outdoor temperature sensor failure	Contact an authorized service agent or Dometic.
The display shows: E8	Discharge tube temperature sensor failure	Contact an authorized service agent or Dometic.
The display shows: E9	Compressor drive or IPM module fault	Contact an authorized service agent or Dometic.
The display shows: EA	Current sensor fault	Contact an authorized service agent or Dometic.
The display shows: EE	Outdoor EEPROM fault	Contact an authorized service agent or Dometic.
The display shows: EL	LIN-BUS/CI-BUS communication failure	Contact an authorized service agent or Dometic.



## 13 Disposal



Place the packaging material in the appropriate recycling waste bins, wherever possible. Consult a local recycling center or specialist dealer for details about how to dispose of the product in accordance with the applicable disposal regulations.



Protect the environment! Do not dispose of any batteries with general household waste. Return defective or used batteries to your retailer or dispose of them at collection points.

## 14 Warranty

The statutory warranty period applies. If the product is defective, please contact the manufacturer's branch in your country (see [dometic.com/dealer](http://dometic.com/dealer)) or your retailer.

For repair and warranty processing, please include the following documents when you send in the device:

- A copy of the receipt with purchasing date
- A reason for the claim or description of the fault

Note that self-repair or nonprofessional repair can have safety consequences and might void the warranty.

## 15 Technical data

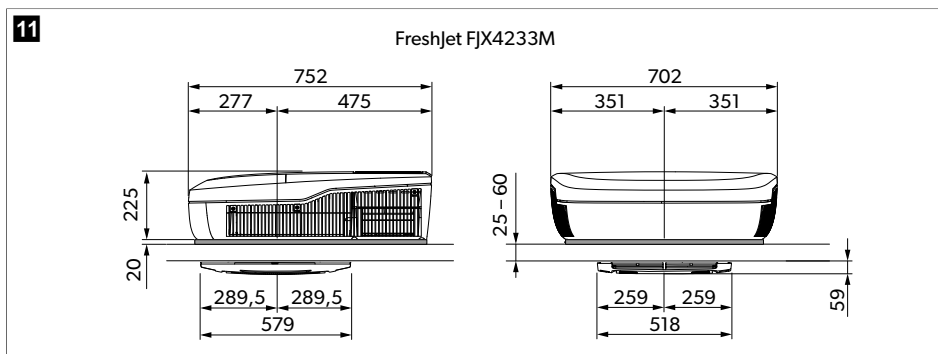

12

FJX4233EEH, FJX4333E(EH), FJX7333IHP

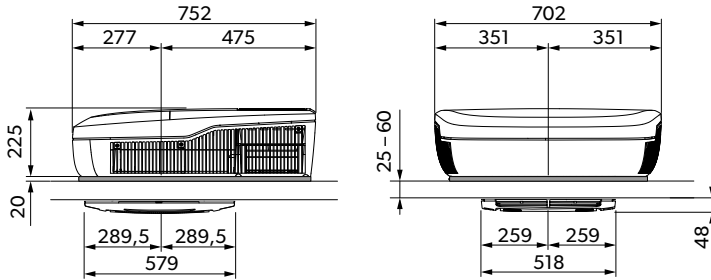

13

FreshJet FJX7337IHP

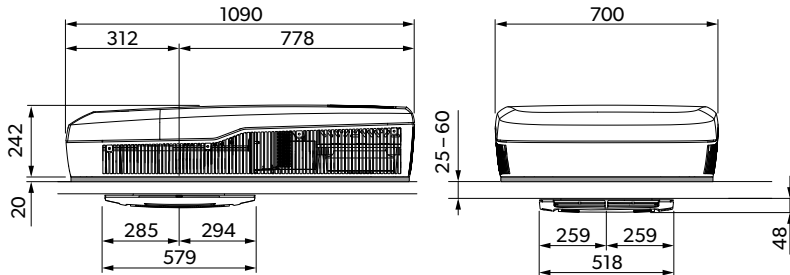

14

FreshJet FJX7457IHP

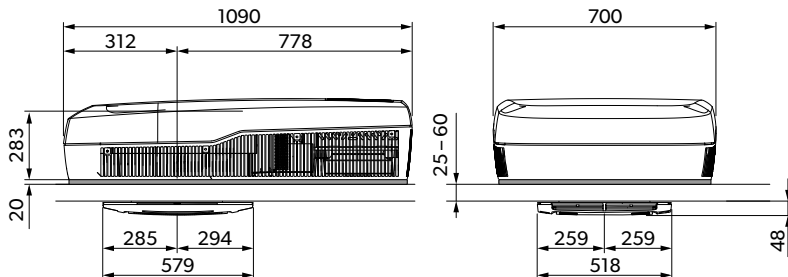

Contains fluorinated greenhouse gases. Hermetically sealed equipment.

	<b>FreshJet FJX4233M</b>
Cooling capacity based on ISO 5151:	1500 W
AC Input voltage:	220 V ... 240 V / 50 Hz

	<b>FreshJet FJX4233M</b>
Rated current cooling:	< 3.3 A
Required fuse:	4 A
Operating temperature range:	- 2 °C ... 52 °C
Refrigerant:	R410a
Refrigerant quantity:	380 g
CO <sub>2</sub> equivalent:	0.793 t
Global warming potential (GWP):	2088
Protection class (roof top unit):	IPX4
Noise level (highest fan setting)	< 70 dB(A)
Suggested max. vehicle length (with insulated walls):	< 5 m
Dimensions L x W x H:	fig. 11 on page 25
Weight:	< 30 kg
Inspection/certification:	

	<b>FreshJet FJX4233EEH</b>	<b>FreshJet FJX4333EEH</b>	<b>FreshJet FJX4333E</b>
Cooling capacity based on ISO 5151:	1700 W	2200 W	2200 W
Heating capacity based on ISO 5151:	800 W	1000 W	-
AC Input voltage:	220 V ... 240 V / 50 Hz		
Rated current cooling:	3.6 A	4.8 A	4.8 A
Rated current heating:	< 5.2 A	< 5.2 A	-
Required fuse:	4 A	5 A	6 A
Operating temperature range:	- 2 °C ... 52 °C		
Refrigerant:	R32		
Refrigerant quantity:	320 g	360 g	360 g
CO <sub>2</sub> equivalent:	0.216 t	0.243 t	0.243 t

	FreshJet FJX4233EEH	FreshJet FJX4333EEH	FreshJet FJX4333E
Global warming potential (GWP):	675		
Protection class (roof top unit):	IPX4		
Noise level (highest fan setting)	< 70 dB(A)		
Suggested max. vehicle length (with insulated walls):	< 6 m	< 7 m	< 7 m
Dimensions L x W x H:	fig. 12 on page 26		
Weight:	< 30 kg	< 30 kg	< 30 kg
Inspection/certification:			

	FreshJet FJX7333IHP	FreshJet FJX7337IHP	FreshJet FJX7457IHP
Cooling capacity based on ISO 5151:	2200 W	3000 W	3500 W
Heating capacity based on ISO 5151:	2000 W	2500 W	3000 W
AC Input voltage:	220 V ... 240 V / 50 Hz ... 60 Hz	220 V ... 240 V / 50 Hz ... 60 Hz	220 V ... 240 V / 50 Hz ... 60 Hz
Rated current cooling:	< 7.5 A	< 7.5 A	< 7.5 A
Rated current heating:	< 6.1 A	< 6.1 A	< 6.1 A
Required fuse:	6 A	6 A	6 A
Operating temperature range:	- 2 °C ... 52 °C	- 2 °C ... 52 °C	- 2 °C ... 52 °C
Refrigerant:	R32	R32	R32
Refrigerant quantity:	420 g	480 g	650 g
CO <sub>2</sub> equivalent:	0.2835 t	0.3240 t	0.43875 t
Global warming potential (GWP):	675		
Protection class (roof top unit):	IPX4		
Noise level (highest fan setting)	< 70 dB(A)		
Suggested max. vehicle length (with insulated walls):	< 7 m	< 7 m	> 8 m

	<b>FreshJet FJX7333IHP</b>	<b>FreshJet FJX7337IHP</b>	<b>FreshJet FJX7457IHP</b>
Dimensions L x W x H:	fig. <b>12</b> on page 26	fig. <b>13</b> on page 26	fig. <b>14</b> on page 26
Weight:	< 30 kg	< 35 kg	< 40 kg
Inspection/certification:			

## German

1	Important notes.....	30
2	Erklärung der Symbole.....	30
3	Sicherheitshinweise.....	32
4	Bestimmungsgemäßer Gebrauch.....	33
5	Erklärung der Symbole am Gerät.....	34
6	Technische Grenzen und Bedingungen.....	34
7	Technische Beschreibung.....	34
8	Vor dem ersten Gebrauch.....	40
9	Betrieb.....	40
10	Dachklimaanlage reinigen.....	48
11	Wartung.....	48
12	Fehlersuche und Fehlerbehebung.....	50
13	Entsorgung.....	53
14	Garantie.....	53
15	Technische Daten.....	53

## 1 Important notes

Lesen und befolgen Sie bitte alle Anweisungen, Richtlinien und Warnhinweise in diesem Produkthandbuch sorgfältig, um sicherzustellen, dass Sie das Produkt ordnungsgemäß installieren und stets ordnungsgemäß betreiben und warten. Diese Anleitung MUSS bei dem Produkt verbleiben.

Durch die Verwendung des Produktes bestätigen Sie hiermit, dass Sie alle Anweisungen, Richtlinien und Warnhinweise sorgfältig gelesen haben und dass Sie die hierin dargelegten Bestimmungen verstanden haben und ihnen zustimmen. Sie erklären sich damit einverstanden, dieses Produkt nur für den angegebenen Verwendungszweck und gemäß den Anweisungen, Richtlinien und Warnhinweisen dieses Produkthandbuchs sowie gemäß allen geltenden Gesetzen und Vorschriften zu verwenden. Eine Nichtbeachtung der hierin enthaltenen Anweisungen und Warnhinweise kann zu einer Verletzung Ihrer selbst und anderer Personen, zu Schäden an Ihrem Produkt oder zu Schäden an anderem Eigentum in der Umgebung führen. Dieses Produkthandbuch, einschließlich der Anweisungen, Richtlinien und Warnhinweise, sowie die zugehörige Dokumentation können Änderungen und Aktualisierungen unterliegen. Aktuelle Produktinformationen finden Sie unter [documents.dometic.com](http://documents.dometic.com).

## 2 Erklärung der Symbole



**GEFAHR!** Kennzeichnet eine Gefahrensituation, die zum Tod oder schwerer Verletzung führt, wenn die jeweiligen Anweisungen nicht befolgt werden.



**WARNUNG!** Kennzeichnet eine Gefahrensituation, die zum Tod oder schwerer Verletzung führt, wenn die jeweiligen Anweisungen nicht befolgt werden.



**VORSICHT!** Kennzeichnet eine Gefahrensituation, die zu geringer oder mittelschwerer Verletzung führen könnte, wenn die jeweiligen Anweisungen nicht befolgt werden.



**ACHTUNG!** Kennzeichnet eine Gefahrensituation, die zu geringer oder mittelschwerer Verletzung führen könnte, wenn die jeweiligen Anweisungen nicht befolgt werden.



**Hinweis** Ergänzende Informationen zur Bedienung des Produktes.

### 3 Sicherheitshinweise



**WARNUNG! Nichtbeachtung dieser Warnungen kann zum Tod oder schwerer Verletzung führen.**

- **Elektrogeräte sind kein Kinderspielzeug!** Das Gerät ist nicht für die Benutzung durch Personen (einschließlich Kinder) mit eingeschränkten physischen, sensorischen oder geistigen Fähigkeiten oder Mangel an Erfahrung und/oder Wissen geeignet, es sei denn, sie werden beaufsichtigt oder wurden im sicheren Gebrauch des Gerätes unterwiesen.
- Kinder müssen beaufsichtigt werden um sicherzustellen, dass sie nicht mit dem Gerät spielen.
- Dieses Gerät kann von Kindern ab 8 Jahren und von Personen mit verringerten physischen, sensorischen oder geistigen Fähigkeiten oder Mangel an Erfahrung und/oder Wissen verwendet werden, wenn diese Personen beaufsichtigt oder im sicheren Gebrauch des Gerätes unterwiesen wurden und die daraus resultierenden Gefahren verstanden haben.
- Die Reinigung darf nicht von Kindern ohne Aufsicht durchgeführt werden.
- Jede Person, die an einem Kältemittelkreislauf arbeitet oder in diesen eingreift, sollte im Besitz eines aktuellen, gültigen Zertifikats einer von der Industrie anerkannten Prüfstelle sein, das ihre Kompetenz zum sicheren Umgang mit Kältemitteln gemäß einer von der Industrie anerkannten Prüfspezifikation bestätigt.
- Die Wartung darf nur gemäß den Empfehlungen des Geräteherstellers durchgeführt werden. Wartungs- und Reparaturarbeiten, die die Hilfe anderer qualifizierter Personen erfordern, sind unter der Aufsicht der für den Umgang mit brennbaren Kältemitteln geschulten Person durchzuführen.
- Die Reparatur des Geräts darf nur von Fachkräften durchgeführt werden, die mit den verbundenen Gefahren bzw. den einschlägigen Vorschriften vertraut sind. Durch unsachgemäße Reparaturen können erhebliche Gefahren entstehen. Wenn Reparaturen notwendig sind, wenden Sie sich an den Kundendienst in Ihrem Land (siehe [dometic.com/dealer](http://dometic.com/dealer)).
- Unterbrechen Sie bei Arbeiten am Gerät immer die Stromversorgung.
- Das Gerät muss in einem Raum aufbewahrt werden, in dem keine Zündquellen wie offene Flammen, ein in Betrieb befindliches Gasgerät oder ein in Betrieb befindliches elektrisches Heizgerät ständig in Betrieb sind.
- Das Gerät darf nicht durchstochen oder verbrannt werden.
- Beachten Sie, dass Kältemittel möglicherweise keinen Geruch aufweisen.
- Setzen Sie das Gerät nicht in der Nähe von entflammaren Flüssigkeiten oder in geschlossenen Räumen ein.
- Achten Sie darauf, dass brennbare Gegenstände nicht im Bereich des Luftaustritts gelagert oder montiert sind. Der Abstand muss mindestens 50 cm betragen.
- Halten Sie die Lüftungsöffnungen frei von Hindernissen.
- Beschädigen Sie nicht den Kältekreislauf.
- Auf keinen Fall dürfen bei der Suche nach Kältemittellocks oder beim Aufspüren von Kältemittellocks potenzielle Zündquellen verwendet werden. Ein Halogenidbrenner (oder ein anderer Detektor mit offener Flamme) darf nicht verwendet werden.
- Die Dachklimaanlage ist für die Montage an einem Fahrzeug mit einer Bodenfläche von größer als 4 m<sup>2</sup> vorgesehen.





**VORSICHT! Nichtbeachtung dieser Hinweise kann zu leichten bis mittelschweren Verletzungen führen.**

- Greifen Sie nicht in Lüftungsauslässe und führen Sie keine Fremdgegenstände in das Gerät ein.
- Im Falle von Feuer lösen Sie nicht den oberen Deckel des Geräts. Verwenden Sie stattdessen zugelassene Löschmittel. Verwenden Sie kein Wasser zum Löschen.
- Wenn das Anschlusskabel beschädigt ist, muss es durch den Hersteller, seinen Kundendienst oder eine ähnlich qualifizierte Fachkraft ersetzt werden, um Gefährdungen zu vermeiden.
- Falls das Gerät einen Ionisator enthält, ziehen Sie Ihren Arzt zu Rate, wenn Sie an einer Erkrankung leiden. Der Ionisator kann Ozon (O<sub>3</sub>) in kleinen Mengen erzeugen. Wenn Sie an Lungenerkrankungen, Asthma, Herzkrankungen, Atemwegserkrankungen, Atemwegsproblemen leiden oder eine Ozonempfindlichkeit aufweisen, ziehen Sie Ihren Arzt zu Rate, um festzustellen, ob die Verwendung dieses Geräts für Sie sicher ist.



**ACHTUNG! Beschädigungsgefahr**

- Verwenden Sie keine anderen als die vom Hersteller empfohlenen Mittel zur Beschleunigung des Abtauprozesses oder zur Reinigung.
- Das Gerät ist so zu lagern, dass eine mechanische Beschädigung vermieden wird.
- Führen Sie keine Änderungen oder Umbauten am Gerät durch!
- Bei angebauter Anlage dürfen Sie auf keinen Fall mit Ihrem Fahrzeug durch automatische Waschanlagen fahren.
- Treten Störungen im Kältemittelkreislauf auf, muss das Gerät vom Hersteller, seinem Kundendienst oder einer ähnlich qualifizierten Fachkraft überprüft und repariert werden, um Gefährdungen zu vermeiden.

## 4 Bestimmungsgemäßer Gebrauch

Die Dachklimaanlage FreshJet FJX ist nur für die Montage auf dem Dach eines Wohnwagens oder Freizeitfahrzeugs zur Kühlung vorgesehen.

Die Dachklimaanlage ist **nicht** für Züge, Häuser und Wohnungen geeignet. Die Dachklimaanlage ist **nicht** für die Montage in Baumaschinen, Landmaschinen oder ähnlichen Arbeitsgeräten geeignet.

Dieses Produkt ist nur für den angegebenen Verwendungszweck und die Anwendung gemäß dieser Anleitung geeignet.

Dieses Handbuch enthält Informationen, die für die ordnungsgemäße Installation und/oder den ordnungsgemäßen Betrieb des Produkts erforderlich sind. Installationsfehler und/oder ein nicht ordnungsgemäßer Betrieb oder eine nicht ordnungsgemäße Wartung haben eine unzureichende Leistung und u. U. einen Ausfall des Geräts zur Folge.

Der Hersteller übernimmt keine Haftung für Verletzungen oder Schäden am Produkt, die durch Folgendes entstehen:

- Unsachgemäße Montage oder falscher Anschluss, einschließlich Überspannung
- Unsachgemäße Wartung oder Verwendung von anderen als den vom Hersteller gelieferten Original-Ersatzteilen
- Veränderungen am Produkt ohne ausdrückliche Genehmigung des Herstellers
- Verwendung für andere als die in der Anleitung beschriebenen Zwecke

Dometic behält sich das Recht vor, das Erscheinungsbild des Produkts und dessen technische Daten zu ändern.

## 5 Erklärung der Symbole am Gerät



Warnung! Material mit geringer Abbrandgeschwindigkeit.



Lesen Sie die Bedienungsanleitung.



Lesen Sie das Servicehandbuch.

## 6 Technische Grenzen und Bedingungen

Die Dachklimaanlage ist für Fahrzeuge mit einer Dachstärke von 25 mm ... 60 mm vorgesehen. Die Funktion der Dachklimaanlage ist bei Umgebungstemperaturen zwischen  $-2\text{ }^{\circ}\text{C}$  ...  $52\text{ }^{\circ}\text{C}$  gewährleistet. Die Dachklimaanlage ist für den Einbau innerhalb von  $\pm 10\text{ }^{\circ}$  zur horizontalen Ebene vorgesehen. Die Leistung der Dachklimaanlage kann beeinträchtigt werden, wenn sie starken Vibrationen ausgesetzt ist, z. B. durch schlechte Straßenverhältnisse.

## 7 Technische Beschreibung

Die Dachklimaanlage FreshJet FJX4233M versorgt den Fahrzeuginnenraum mit kühler, staub- und schmutzfreier Luft, die entfeuchtet werden kann.

Die Dachklimaanlage FreshJet FJX4233EEH/FJX4333E(EH)/FJX7333IHP/FJX7337IHP/FJX7457IHP versorgt den Fahrzeuginnenraum mit kühler oder warmer Luft, die staub- und schmutzfrei ist und entfeuchtet werden kann.

Die Dachklimaanlage kann die Temperatur im Fahrzeug auf einen bestimmten Wert absenken, der von der Art des Fahrzeugs, der Umgebungstemperatur und der Kühlleistung der Dachklimaanlage abhängt. Unter einer Außentemperatur von  $16\text{ }^{\circ}\text{C}$  kühlt die Dachklimaanlage nicht mehr.

Die Dachklimaanlage wird mit den folgenden Bedienelementen bedient:

- Bedienfeld

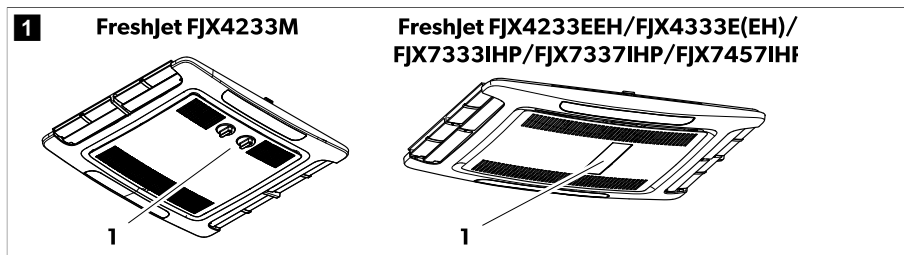

- Fernbedienung (nur FJX4233EEH/FJX4333E(EH)/FJX7333IHP/FJX7337IHP/FJX7457IHP)

### 7.1 Liste der Modelle

Die folgende Tabelle zeigt, welche Funktion für ein bestimmtes Modell gilt:

Funktion ● ist verfügbar

Funktion ○ ist aufrüstbar

	FJX4233M	FJX4233EEH	FJX4333EEH	FJX4333E	FJX7333IHP	FJX7337IHP	FJX7457IHP
Automatik		●	●	●	●	●	●
Kühlung	●	●	●	●	●	●	●
Heizung		●	●	○	●	●	●
Ventilation	●	●	●	●	●	●	●
Entfeuch- tung		●	●	●	●	●	●
Luftreiniger	○	●	●	○	●	●	●
ADB- Leuchte		●	●	○	●	●	●
Außen- beleuchtung					●	●	●
Timer		●	●	●	●	●	●
Sleep		●	●	●	●	●	●
Soft Start			●	○	●	●	●

### 7.2 Bedienfeld FreshJet FJX4233M

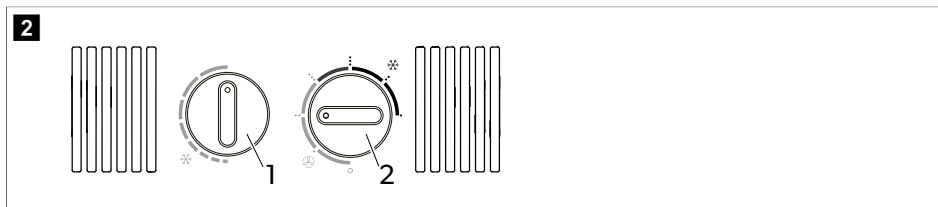

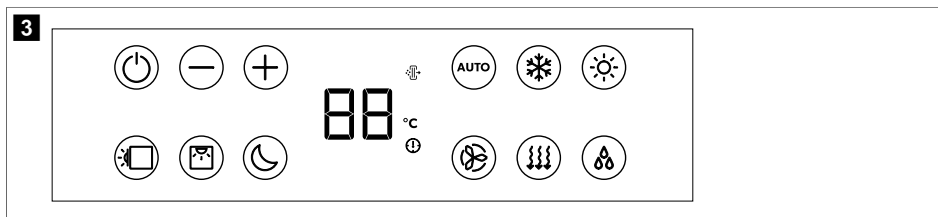

Knopf	Beschreibung
	Wählt die Temperatur aus. Für eine stärkere Kühlung im Uhrzeigersinn drehen.
	Schaltet die Dachklimaanlage ein oder aus und wählt die Intensität der Luftzirkulation im Lüftermodus (🌀) bzw. die Kühlintensität im Kühlbetrieb (❄️) aus.

### 7.3 Bedienfeld FreshJet FJX4233EEH/FJX4333E(EH)/FJX7333IHP/FJX7337IHP/ FJX7457IHP



















Symbol	Beschreibung
	Schaltet die Dachklimaanlage ein oder in den Standby-Modus.
	Erhöht den aktuell angezeigten Wert.
	Verringert den aktuell angezeigten Wert.
	Stellt eine Verbindung über Bluetooth/WLAN her, wenn beide Tasten gleichzeitig gedrückt werden.
	Schaltet das Umgebungslicht in der Dachklimaanlage ein oder aus.
	Schaltet das Umgebungslicht im Luftverteilerkasten ein oder aus.
	Aktiviert die Sleep-Funktion (Zusatzfunktionen (nur FJX4233EEH/FJX4333E(EH)/FJX7333IHP/FJX7337IHP/ FJX7457IHP) auf Seite 39).
	Zeigt die eingestellte Temperatur an und zeigt die Lüfterstufe an, wenn der Lüfter eingestellt ist.
	Zeigt an, dass der Luftreinigungsmodus aktiv ist.
	Zeigt an, dass die Temperatur in Grad Celsius angezeigt wird.
	Zeigt an, dass der Timer eingestellt ist.
	Aktiviert/deaktiviert den Automatikbetrieb (Klimatisierungsmodi (nur FJX4233EEH/FJX4333E(EH)/ FJX7333IHP/FJX7337IHP/FJX7457IHP) auf Seite 39).
	Aktiviert/deaktiviert den Kühlbetrieb (Klimatisierungsmodi (nur FJX4233EEH/FJX4333E(EH)/FJX7333IHP/ FJX7337IHP/FJX7457IHP) auf Seite 39).
	Aktiviert/deaktiviert den Heizbetrieb (Klimatisierungsmodi (nur FJX4233EEH/FJX4333E(EH)/FJX7333IHP/ FJX7337IHP/FJX7457IHP) auf Seite 39).
	Passt die Lüftergeschwindigkeit zwischen niedrig, mittel, hoch, Turbo oder Automatik an (die Stufen werden bei Änderung für kurze Zeit als 1, 2, 3, 4 oder AA im Display des Luftverteilerkastens angezeigt).

Symbol	Beschreibung
	Aktiviert/deaktiviert den Lüftermodus (Klimatisierungsmodi (nur FJX4233EEH/FJX4333E(EH)/FJX7333IHP/FJX7337IHP/FJX7457IHP) auf Seite 39). Zur Luftzirkulation ohne Heizen oder Kühlen.
	Aktiviert/deaktiviert den Entfeuchtungsbetrieb (Klimatisierungsmodi (nur FJX4233EEH/FJX4333E(EH)/FJX7333IHP/FJX7337IHP/FJX7457IHP) auf Seite 39).

## 7.4 Fernbedienung FreshJet FJX4233EEH/FJX4333E(EH)/FJX7333IHP/ FJX7337IHP/FJX7457IHP





Bedien- und Anzeigeelemente Abb. **4** auf Seite 37:

Taster	Beschreibung
—	<p><b>Display</b></p> <p>Folgendes wird angezeigt:</p> <ul style="list-style-type: none"> <li>• Uhrzeit</li> <li>• ausgewählte Raumtemperatur (Zielwert) in °C</li> <li>• tatsächliche Raumtemperatur</li> <li>• Klimamodus</li> <li>• Lüftungsgeschwindigkeit</li> <li>• Symbole für aktivierte Zusatzfunktionen</li> <li>• Batteriestatus</li> </ul>
	Schaltet die Dachklimaanlage ein oder in den Stand-By-Modus.
	Erhöht den aktuell angezeigten Wert.
	Verringert den aktuell angezeigten Wert.
	Wählt die Lüfterdrehzahl aus (Gebläsestufe manuell wählen auf Seite 43).
	Zum Auswählen des Klimamodus (Klimatisierungsmodi (nur FJX4233EEH/FJX4333E(EH)/FJX7333IHP/FJX7337IHP/FJX7457IHP) auf Seite 39). Das entsprechende Symbol wird angezeigt.
	Aktiviert die Sleep-Funktion (Zusatzfunktionen (nur FJX4233EEH/FJX4333E(EH)/FJX7333IHP/FJX7337IHP/FJX7457IHP) auf Seite 39). Das Symbol  wird angezeigt.
	Bestätigt und speichert die Einstellungen.
	Stellt den Timer und die Uhr ein.
	Schaltet das Umgebungslicht im Luftverteilerkasten ein oder aus.
	Einmal drücken, um die aktuelle Innentemperatur anzuzeigen. Das Symbol  wird angezeigt. Zweimal drücken, um die eingestellte Temperatur anzuzeigen.
	Aktiviert die I Feel-Funktion. Das Symbol  wird angezeigt. Die I Feel-Funktion gleicht alle 10 min die Zieltemperatur mit der von der Fernbedienung gemessenen tatsächlichen Temperatur ab.
	Schaltet das Umgebungslicht in der Dachklimaanlage ein oder aus.
	Zeigt an, dass die Batterien der Fernbedienung leer sind. Ersetzen Sie die Batterien (Batterien der Fernbedienung austauschen auf Seite 46).
	Zeigt an, dass die Fernbedienung Werte an die Dachklimaanlage sendet.





## 7.5 Klimamodi (nur FJX4233M)

Die Dachklimaanlage verfügt über folgende Klimamodi:

Klimamodus	Angezeigtes Symbol	Beschreibung
Kühlung		Sie legen die Temperatur und die Lüftereinstellungen fest und die Dachklimaanlage kühlt den Innenraum auf diese Temperatur.
Ventilation		Sie legen die Lüftereinstellungen fest und die Dachklimaanlage zirkuliert Luft, ohne zu heizen oder zu kühlen.





## 7.6 Klimatisierungsmodi (nur FJX4233EEH/FJX4333E(EH)/FJX7333IHP/FJX7337IHP/FJX7457IHP)

Die Dachklimaanlage verfügt über folgende Klimamodi:

Klimamodus	Angezeigtes Symbol	Beschreibung
Automatik	<b>A</b>	Sie legen die Temperatur fest und die Dachklimaanlage bringt den Innenraum durch Kühlen oder Heizen und durch Regeln der erforderlichen Lüfterdrehzahl auf diese Temperatur.
Kühlung		Sie legen die Temperatur und die Lüftereinstellungen fest und die Dachklimaanlage kühlt den Innenraum auf diese Temperatur.
Heizung		<b>Nicht FJX4333E:</b> Sie legen die Temperatur und die Lüftereinstellungen fest und die Dachklimaanlage heizt den Innenraum auf diese Temperatur. Der Lüfter schaltet sich (bei niedriger Drehzahl) erst nach 2 min ein und stellt sich nach ca. 5 min auf die eingestellte Lüfterdrehzahl ein (nachdem der Verdampfer die Betriebstemperatur erreicht hat).
Ventilation		Sie legen die Lüftereinstellungen fest und die Dachklimaanlage zirkuliert Luft, ohne zu heizen oder zu kühlen.
Luftfeuchtung		Die Dachklimaanlage entzieht der Luft Feuchtigkeit, ohne den Innenraum zu heizen oder zu kühlen, und senkt so die relative Luftfeuchtigkeit.
Luftreiniger		<b>Nicht FJX4333E:</b> Die Dachklimaanlage ionisiert die Luft, wodurch Staub und Partikel, einschließlich Viren und Bakterien, aus der Luft aufgenommen werden.

## 7.7 Zusatzfunktionen (nur FJX4233EEH/FJX4333E(EH)/FJX7333IHP/FJX7337IHP/FJX7457IHP)

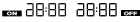
Die Dachklimaanlage bietet folgende Zusatzfunktionen:

Zusatzfunktionen	Displaymeldung	Beschreibung
Timer		Die Dachklimaanlage wird zu der festgelegten Uhrzeit eingeschaltet.
		Die Dachklimaanlage wird zu der festgelegten Uhrzeit ausgeschaltet.
		Die Dachklimaanlage wird zu den festgelegten Uhrzeiten ein- und ausgeschaltet.
Sleep		Die Sleep-Funktion regelt die Lüftergeschwindigkeit und die Kompressordrehzahl nach unten, um den Geräuschpegel für einen angenehmen Schlaf zu reduzieren.
I Feel		Die Fernbedienung misst die Raumtemperatur und überträgt den Messwert alle 10 min an die Dachklimaanlage. Die Dachklimaanlage stimmt den Zielwert mit diesem Messwert ab.
Soft Start		<b>Nicht FJX4233EEH:</b> Der Spitzenstrom, den der Kompressorstart erzeugt, wird durch die Soft-Startfunktion reduziert. Wenn ein Generator als Stromversorgung verwendet wird, wird dieser nicht überlastet.

## 8 Vor dem ersten Gebrauch

### Kontrollen vor der Inbetriebnahme

Bevor Sie die Dachklimaanlage einschalten, beachten Sie bitte Folgendes:

1. Prüfen Sie, ob die Versorgungsspannung und -frequenz den in Technische Daten auf Seite 53 angegebenen Werten entsprechen.
2. Stellen Sie sicher, dass sowohl die Ansaugöffnungen als auch die Luftdüsen frei sind. Alle Lüftungsgitter müssen stets freigehalten werden, um eine maximale Leistung der Dachklimaanlage zu gewährleisten.

### Fernbedienung vorbereiten (nur FreshJet FJX4233EEH/FJX4333E(EH)/FJX7333IHP/FJX7337IHP/FJX7457IHP)

3. Legen Sie die Batterien ein (Batterien der Fernbedienung austauschen auf Seite 46).

### Uhrzeit einstellen (nur FreshJet FJX4233EEH/FJX4333E(EH)/FJX7333IHP/FJX7337IHP/FJX7457IHP)

4. Stellen Sie die aktuelle Uhrzeit ein (Aktuelle Uhrzeit einstellen auf Seite 43).

## 9 Betrieb

### 9.1 Hinweise zur besseren Nutzung

Die folgenden Hinweise dienen zur Optimierung der Leistung der Dachklimaanlage:

- Verbessern Sie die Wärmeisolierung des Fahrzeugs, indem Sie Spalte abdichten und Fenster mit reflektierenden Rollos oder Vorhängen verhängen.
- Wählen Sie eine angemessene Temperatur und Gebläsestufe.
- Richten Sie die Luftdüsen auf geeignete Weise aus.



- Achten Sie darauf, dass die Luftdüsen und Luftansaugöffnungen nicht durch Tücher, Papier oder andere Gegenstände abgedeckt sind.
- **Nur FreshJet FJX4233EEH/FJX4333E(EH)/FJX7333IHP/FJX7337IHP/FJX7457IHP:** Falls das Fahrzeug lange Zeit Sonnenbestrahlung ausgesetzt war: Betreiben Sie die Dachklimaanlage zunächst einige Zeit bei geöffneten Fenstern im Lüftermodus (🌀), bevor Sie den Kühlbetrieb (❄️) einschalten.
- **Nur FreshJet FJX4233EEH/FJX4333E(EH)/FJX7333IHP/FJX7337IHP/FJX7457IHP:** Vermeiden Sie im Kühlbetrieb (❄️) möglichst das Öffnen von Türen und Fenstern.

## 9.2 Grundsätzliche Hinweise zur Bedienung

Die Dachklimaanlage FreshJet FJX4233M verfügt über drei Betriebsmodi:

Betriebsmodus	Beschreibung
Aus	Die Dachklimaanlage ist ausgeschaltet.
Kühlung	Die Dachklimaanlage kühlt den Innenraum.
Ventilation	Die Dachklimaanlage zirkuliert Luft, ohne zu kühlen.

Die Dachklimaanlage FreshJet FJX4233EEH/FJX4333E(EH)/FJX7333IHP/FJX7337IHP/FJX7457IHP verfügt über zwei Betriebsmodi:

Betriebsmodus	Beschreibung
Standby	Die Dachklimaanlage ist betriebsbereit und kann mit der Fernbedienung eingeschaltet werden. Das Umgebungslicht ist verfügbar. Die Fernbedienung befindet sich ebenfalls im Standby-Modus, aber Sie können die Fernbedienung unabhängig von der Dachklimaanlage einschalten.
On	Die Dachklimaanlage klimatisiert die Luft im Innenraum.

## 9.3 Dometic FJX4233M

Die in diesem Kapitel aufgeführten Informationen gelten nur für die Dachklimaanlagen FJX4233M.

### 9.3.1 Dachklimaanlage ein- und ausschalten

Die Dachklimaanlage verfügt über zwei Klimamodi:

- Lüftermodus (🌀)
- Kühlbetrieb (❄️)





**Hinweis** Warten Sie mindestens 30 s, bevor Sie vom Lüftermodus in den Kühlbetrieb oder umgekehrt umschalten. Ansonsten kann durch den Schaltstrom die Sicherung durchbrennen.

Jeder Modus verfügt über drei Einstellungen:

- .: gering

- ...: Mittel
  - ...: hoch
- >

Zum Einschalten drehen Sie den Knopf  in die Stellung für den Lüftermodus () oder in die Stellung für den Kühlbetrieb () und wählen Sie die gewünschte Einstellung.

- ✓ Die Dachklimaanlage wird eingeschaltet und arbeitet mit den Werten, die vor dem Ausschalten eingestellt wurden.

>

Zum Ausschalten drehen Sie den Knopf  in die Stellung 0.

### 9.3.2 Temperatur einstellen

>

Drehen Sie den Knopf  in die gewünschte Stellung. Durch Drehen des Knopfes im Uhrzeigersinn wird eine kühlere Temperatur eingestellt.

- ✓ Die Temperatur wird in der Dachklimaanlage eingestellt.

## 9.4 FreshJet FJX4233EEH/FJX4333E(EH)/FJX7333IHP/FJX7337IHP/FJX7457IHP

Die in diesem Kapitel aufgeführten Informationen gelten nur für die Dachklimaanlagen FreshJet FJX4233EEH/FJX4333E(EH)/FJX7333IHP/FJX7337IHP/FJX7457IHP.

### 9.4.1 Mit der Fernbedienung

Beachten Sie bei der Verwendung der Fernbedienung die folgenden Hinweise:



- Richten Sie die Fernbedienung auf den IR-Empfänger des Bedienfelds.
- Die entsprechenden Einstellungen und Werte werden direkt an die Dachklimaanlage übertragen, wenn Sie eine Taste drücken.
- Die Dachklimaanlage bestätigt den Datenempfang mit einem Piepton.
- Die Werte werden schneller erhöht bzw. verringert, wenn Sie die Taste + oder – gedrückt halten.
- Im Standby-Modus ist auch das Display der Fernbedienung inaktiv. Sie können die Fernbedienung unabhängig von der Dachklimaanlage in den Standby-Modus schalten.

- > Um nur die Fernbedienung in den oder aus dem Standby-Modus zu schalten, drücken Sie die Taste , während Sie die Fernbedienung nicht auf den IR-Empfänger des Bedienfelds richten.

### 9.4.2 Dachklimaanlage ein- und in den Standby-Modus schalten



**Hinweis** Wenn die Dachklimaanlage eingeschaltet wird, arbeitet sie mit den Werten, die vor dem Schalten in den Standby-Modus eingestellt wurden. Die Dachklimaanlage kann nur durch Unterbrechen der Stromversorgung ausgeschaltet werden.

- > Drücken Sie die Taste  auf der Fernbedienung oder die Taste  auf dem Bedienfeld, um die Dachklimaanlage einzuschalten oder in den Standby-Modus zu versetzen.



### 9.4.3 Klimamodus wählen

- > Wählen Sie mithilfe der Taste MODE den gewünschten Klimamodus aus (Klimatisierungsmodi (nur FJX4233EEH/FJX4333E(EH)/FJX7333IHP/FJX7337IHP/FJX7457IHP) auf Seite 39).
- ✓ Die Dachklimaanlage bestätigt den Empfang der Werte mit einem Piepton. Die Dachklimaanlage wird in den gewählten Klimamodus geschaltet.

### 9.4.4 Gebläsestufe manuell wählen

In allen Klimamodi außer dem Automatik- (**A**) und dem Entfeuchtungsbetrieb (☉) kann die Lüftergeschwindigkeit manuell ausgewählt werden.

Displaymeldung	Beschreibung
	Niedrige Lüfterstufe
	Mittlere Lüfterstufe
	Hohe Lüfterstufe
	Turbo-Lüfterstufe
	Automatikbetrieb (die Lüftergeschwindigkeit wird auf Basis der Umgebungstemperatur angepasst).

- > Drücken Sie die Taste  auf der Fernbedienung oder die Taste  auf dem Bedienfeld, um die gewünschte Lüftergeschwindigkeit auszuwählen.
- ✓ Die Dachklimaanlage bestätigt den Empfang der Werte mit einem Piepton.  
Die Lüfterdrehzahl wird eingestellt.

### 9.4.5 Temperatur einstellen

Im Automatik- (**A**), Kühl- (❄️), Heiz- (☀️) und Entfeuchtungsbetrieb (☉) können Sie eine Temperatur zwischen 16 °C und 31 °C einstellen.

- > Stellen Sie mit der Taste + oder – auf der Fernbedienung die gewünschte Temperatur ein.
- ✓ Die Dachklimaanlage bestätigt den Empfang der Werte mit einem Piepton. Die Temperatur wird in der Dachklimaanlage eingestellt.

### 9.4.6 Aktuelle Uhrzeit einstellen

Die Fernbedienung benötigt zur Timerprogrammierung die aktuelle Uhrzeit. Die Uhrzeit wird auf dem Display der Fernbedienung angezeigt.

1. Halten Sie die Taste  gedrückt, um in den Modus zum Einstellen der Uhrzeit zu gelangen.  
✓ Die Uhrzeit blinkt auf dem Display der Fernbedienung.
2. Stellen Sie mit der Taste + oder – die Uhrzeit ein. Halten Sie die Taste + oder – länger als 2 s gedrückt, um die Uhrzeit schneller zu erhöhen oder zu verringern.
3. Drücken Sie die Taste SET, um die Uhrzeit zu bestätigen.

### 9.4.7 Timer programmieren

Mit der Timerfunktion können Sie einen bestimmten Zeitraum für die Klimatisierung einstellen. Sie können die Einschaltzeit, die Uhrzeit zum Schalten in den Standby-Modus oder beide Werte einstellen.

Die Timerfunktion wird über die Fernbedienung eingestellt.



**Hinweis** Wird bei der Timerprogrammierung für 15 s keine Taste auf der Fernbedienung gedrückt, so wechselt die Fernbedienung zurück zum Ausgangsmodus.







- > Zum Einstellen des **Einschalttimers** gehen Sie wie folgt vor:
  - a) Wählen Sie den gewünschten Klimatisierungsmodus und alle erforderlichen Werte (z. B. die Temperatur).
  - b) Schalten Sie ggf. die Dachklimaanlage auf Standby.  
Der Einschalttimer kann nur eingestellt werden, wenn sich die Dachklimaanlage im **Standby**-Modus befindet.
  - c) Drücken Sie einmal die Taste .
  - ✓ Auf dem Display der Fernbedienung blinkt das Symbol .
  - d) Stellen Sie mit der Taste + oder – die Uhrzeit ein, zu der die Dachklimaanlage eingeschaltet werden soll.
  - e) Drücken Sie die Taste .  
Der Einschalttimer ist eingestellt. Die Dachklimaanlage wird zur festgelegten Uhrzeit mit dem gewählten Klimatisierungsmodus eingeschaltet.
- > Zum Einstellen des **Standbytimers** gehen Sie wie folgt vor:
  - a) Schalten Sie ggf. die Dachklimaanlage ein.  
Der Standbytimer kann nur eingestellt werden, wenn die Dachklimaanlage **eingeschaltet** ist.
  - b) Drücken Sie die Taste  zweimal.
  - ✓ Auf dem Display der Fernbedienung blinkt das Symbol .
  - c) Stellen Sie mit der Taste + oder – die Uhrzeit ein, zu der die Dachklimaanlage in den Standby-Modus geschaltet werden soll.
  - d) Drücken Sie die Taste .  
Der Standbytimer ist eingestellt. Die Dachklimaanlage wird zur festgelegten Uhrzeit in den Standby-Modus versetzt.
- > Zum Einstellen des **Einschalttimers** und des **Standbytimers** gehen Sie wie folgt vor:
  - a) Wählen Sie den gewünschten Klimatisierungsmodus und alle erforderlichen Werte (z. B. die Temperatur).
  - b) Drücken Sie die Taste  dreimal.
  - ✓ Das Symbol   wird auf dem Display der Fernbedienung angezeigt. Das Symbol ON blinkt.
  - c) Stellen Sie mit der Taste + oder – die Uhrzeit ein, zu der die Dachklimaanlage eingeschaltet werden soll.
  - d) Drücken Sie die Taste .
  - ✓ Das Symbol **OFF** blinkt.
  - e) Stellen Sie mit der Taste + oder – die Uhrzeit ein, zu der die Dachklimaanlage in den Standby-Modus geschaltet werden soll.
  - f) Drücken Sie die Taste .  
✓ Die Einschaltzeit und die Uhrzeit zum Schalten in den Standby-Modus sind eingestellt. Die Dachklimaanlage wird für die festgelegte Zeitspanne eingeschaltet.
- > Um einen voreingestellten Timer **abzubrechen**, drücken Sie einmal die Taste .
- ✓ Die Symbole   werden nicht mehr angezeigt. Die voreingestellten Werte werden verworfen.

### 9.4.8 Sleep-Funktion einstellen

Die Sleep-Funktion ist nur im Kühl- (❄️) oder Heizbetrieb (☀️) verfügbar.

Die Sleep-Funktion begrenzt die Lüftergeschwindigkeit auf einen niedrigeren Wert, um den Geräuschpegel für einen angenehmeren Schlaf zu reduzieren.

**Nur FJX7333IHP/FJX7337IHP/FJX7457IHP:** Die Sleep-Funktion begrenzt zudem die Kompressordrehzahl.

- > Um die Sleep-Funktion zu aktivieren, gehen Sie wie folgt vor:
  - a) Stellen Sie die gewünschte Temperatur ein (Temperatur einstellen auf Seite 43).
  - b) Drücken Sie die Taste  auf der Fernbedienung oder die Taste  auf dem Bedienfeld.
- ✓ Auf dem Display der Fernbedienung wird das Symbol  angezeigt. Die Sleep-Funktion ist aktiviert.
  - > Um die Sleep-Funktion zu deaktivieren, drücken Sie die Taste  oder  auf der Fernbedienung oder die Taste  auf dem Bedienfeld.
- ✓ Das Symbol  wird nicht mehr auf dem Display der Fernbedienung angezeigt. Die Sleep-Funktion ist deaktiviert.

### 9.4.9 I Feel-Funktion aktivieren

Bei aktiver Funktion misst die Fernbedienung die Raumtemperatur und überträgt den Messwert alle 10 Minuten an die Dachklimaanlage. Die Dachklimaanlage stimmt den Zielwert mit diesem Messwert ab. Die „I Feel“-Funktion ist nur aktiv, wenn die Temperatur zwischen +18 °C und +29 °C liegt.

Die Fernbedienung sollte sich nicht in einem Bereich des Raums befinden, der wesentlich wärmer oder kälter als die durchschnittliche Raumtemperatur ist. Sie darf beispielsweise nicht in der Sonne oder vor der Dachklimaanlage liegen.

Wenn die Temperatur über +29 °C steigt oder unter +18 °C fällt, wird die „I Feel“-Funktion deaktiviert. Das Symbol  blinkt dreimal im Display auf und erlischt dann.

1. Drücken Sie die Taste.
- ✓ Die „I Feel“-Funktion ist aktiviert.

Das Symbol  wird im Display angezeigt.

2. Positionieren Sie die Fernbedienung so, dass Sie auf den IR-Empfänger am Bedienfeld gerichtet ist. Sonst können die Werte nicht an die Dachklimaanlage übertragen werden.



### 9.4.10 Umgebungslicht verwenden







**WARNUNG! Verletzungsgefahr** Es ist gesetzlich verboten, die Außenbeleuchtung während der Fahrt mit dem Fahrzeug zu verwenden.

Die Taste  auf der Fernbedienung ist auch dann aktiv, wenn die Fernbedienung ausgeschaltet ist.

**Nur FreshJet FJX4233EEH/FJX4333E(EH)/FJX7333IHP/FJX7337IHP/FJX7457IHP:**

- > Um die Innenbeleuchtung ein- oder auszuschalten, drücken Sie die Taste  auf der Fernbedienung oder auf dem Bedienfeld.
- ✓ Das Symbol  blinkt einmal im Display der Fernbedienung auf, wenn die Innenbeleuchtung **eingeschaltet** wird.

- > Gehen Sie wie folgt vor, um die Innenbeleuchtung zu dimmen:
  - a) Drücken Sie die Taste  auf der Fernbedienung oder auf dem Bedienfeld 3 s lang.
  - b) Bei Drücken der Taste  auf der Fernbedienung: Drücken Sie die Taste , um die Innenbeleuchtung zwischen 50 % und 100 % zu dimmen.
  - c) Bei Drücken der Taste  auf dem Bedienfeld: Die Helligkeit der Innenbeleuchtung wechselt zwischen 50 % und 100 %. Lassen Sie die Taste  los, wenn die gewünschte Helligkeit erreicht ist.

#### Nur FreshJet FJX7333IHP/FJX7337IHP/FJX7457IHP:

- > Drücken Sie die Taste  auf dem Bedienfeld, um die Außenbeleuchtung ein- oder auszuschalten.

### 9.4.11 Batterien der Fernbedienung austauschen



**Hinweis** Das Display der Fernbedienung kann auch dann noch hell sein, wenn der Ladestatus der Batterien niedrig ist. Tauschen Sie die Batterien aus, wenn die Fernbedienung einen niedrigen Batterieladestatus anzeigt.

- > Tauschen Sie die Batterien wie gezeigt aus.



- ✓ Das Display zeigt 5 s lang alle Symbole an.



Schützen Sie Ihre Umwelt! Akkus und Batterien gehören nicht in den Hausmüll. Geben Sie bitte Ihre defekten Akkus oder verbrauchten Batterien beim Händler oder bei einer Sammelstelle ab.

## 9.5 Luftzufuhr im Fahrzeug regulieren

Der Luftstrom kann zur Decke oder zum Boden hin eingestellt werden.

- > Drehen Sie die Lamellen in den Luftdüsen unabhängig voneinander in die gewünschten Richtungen.

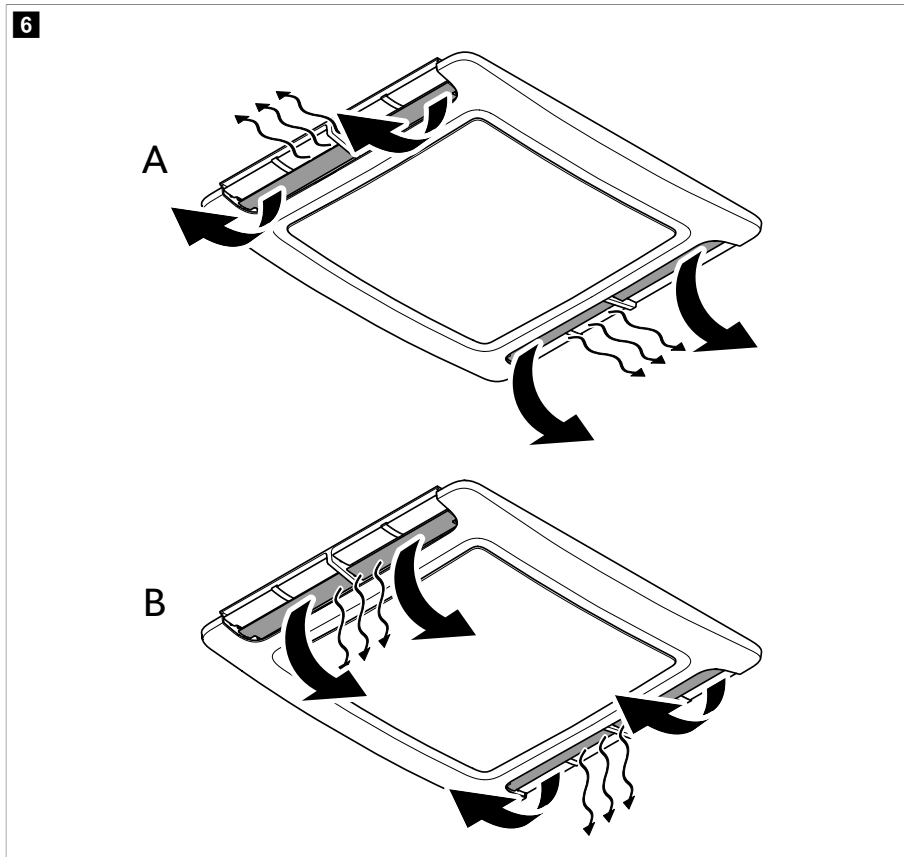

## 10 Dachklimaanlage reinigen



### ACHTUNG! Beschädigungsgefahr

- Verwenden Sie keine anderen als die vom Hersteller empfohlenen Mittel zur Beschleunigung des Abtauprozesses oder zur Reinigung.
- Reinigen Sie die Dachklimaanlage nicht mit einem Hochdruckreiniger. Eindringendes Wasser kann die Dachklimaanlage beschädigen.
- Verwenden Sie keine scharfen oder harten Gegenstände oder scharfen Reinigungsmittel zur Reinigung, da dies zu einer Beschädigung der Dachklimaanlage führen kann.
- Verwenden Sie auf keinen Fall Benzin, Diesel oder Lösungsmittel.

1. Entfernen Sie regelmäßig Laub und anderen Schmutz von den Luftansaugöffnungen und den Lüftungsgittern der Dachklimaanlage. Beschädigen Sie die Lüftungsgitter dabei nicht.

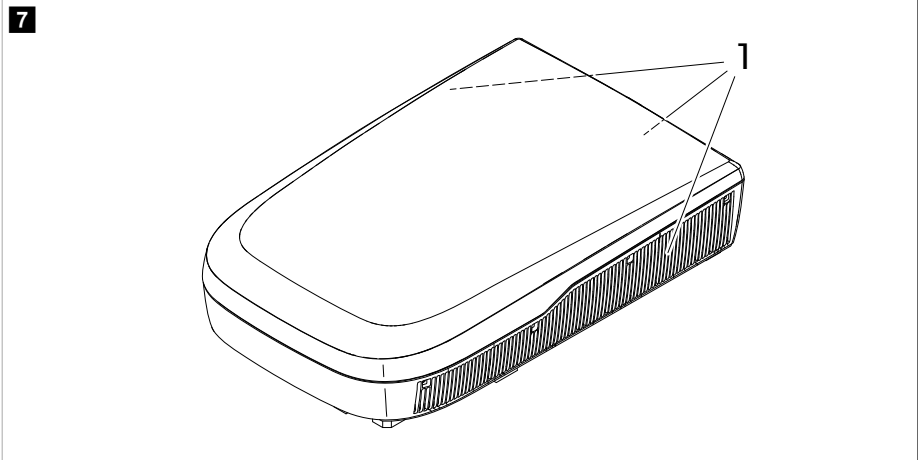

2. Reinigen Sie das Gehäuse der Dachklimaanlage und des Luftverteilerkastens gelegentlich mit einem feuchten Tuch. Verwenden Sie nur Wasser mit einem sanften Reinigungsmittel.
3. **Nur FreshJet FJX4233EEH/FJX4333E(EH)/FJX7333IHP/FJX7337IHP/FJX7457IHP:** Reinigen Sie die Fernbedienung gelegentlich mit einem leicht feuchten Tuch. Reinigen Sie das Display mit einem Brillenputztuch.
4. **Nur FreshJet FJX4233EEH/FJX4333E(EH)/FJX7333IHP/FJX7337IHP/FJX7457IHP** Reinigen Sie das Display des Luftverteilerkastens gelegentlich mit einer milden Lösung aus warmem Seifenwasser. Der Bildschirm des Displays besteht aus Acryl und kann durch einige haushaltsübliche Chemikalien wie chemische Reiniger, Fensterreiniger, Alkohol, bestimmte Tenside, organische Lösungsmittel und Weichmacher beschädigt werden.

## 11 Wartung



**WARNUNG! Verletzungsgefahr** Andere Wartungsarbeiten zusätzlich zu den hier beschriebenen Themen dürfen nur von Fachpersonal durchgeführt werden, das mit den Gefahren beim Umgang mit Kältemitteln und Klimaanlagen sowie den einschlägigen Vorschriften vertraut ist.

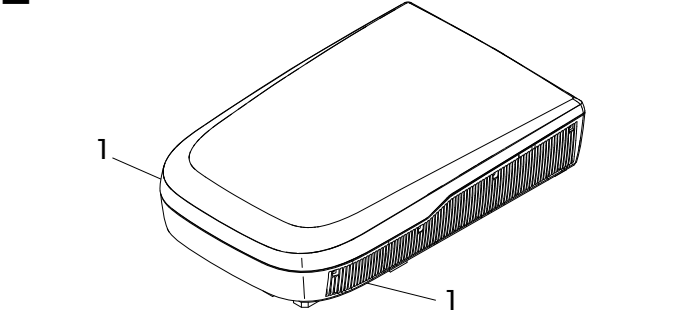
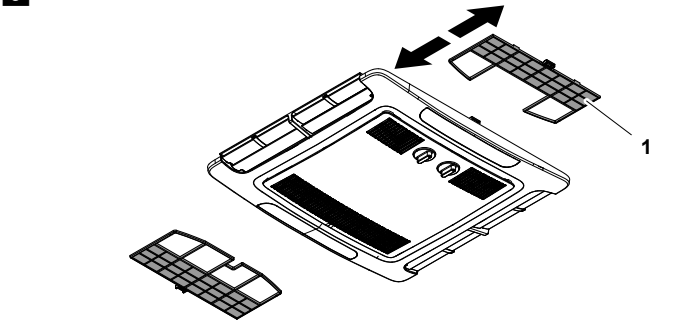

Intervall	Prüfung/Wartung
Regelmäßig	<p data-bbox="333 188 1013 231">Prüfen Sie, ob die Kondenswasserabläufe (1) an den Seiten der Dachklimaanlage frei sind und das entstehende Kondenswasser ablaufen kann.</p> <div data-bbox="333 247 1016 614"><p data-bbox="341 252 367 284"><b>8</b></p></div>
Regelmäßig (Freshjet FJX4233M)	<p data-bbox="333 643 660 667">Reinigen Sie den Filter der Luftauslassseinheit.</p> <div data-bbox="333 678 1016 1045"><p data-bbox="341 683 367 715"><b>9</b></p></div> <ol data-bbox="347 1061 963 1125" style="list-style-type: none"><li>1. Entfernen Sie den Filter (1).</li><li>2. Reinigen Sie die Filter (1) mit einer Reinigungslösung und lassen Sie ihn trocknen.</li><li>3. Setzen Sie den trockenen Filter (1) wieder ein.</li></ol>

Intervall	Prüfung/Wartung
<p>Regelmäßig (FreshJet FjX4233EEH/FjX4333E(E-H)/FjX7333IHP/FjX7337IHP/FjX7457IHP)</p>	<ul style="list-style-type: none"> <li>Reinigen Sie den Filter der Luftauslasseneinheit.</li> </ul> <div data-bbox="367 225 1016 528" style="border: 1px solid black; padding: 10px;"> <p><b>10</b></p>  <p>1. Setzen Sie einen flachen Schraubendreher oder ein Messer in den Griff (1) ein, um die Filter (2) leicht herauszuziehen.  2. Entfernen Sie die Filter mit der Hand.  3. Reinigen Sie die Filter mit einer Reinigungslösung und lassen Sie sie trocknen.  4. Setzen Sie die trockenen Filter wieder ein. Abb. 10 auf Seite 50</p> </div> <ul style="list-style-type: none"> <li>Lassen Sie den Wärmetauscher der Dachklimaanlage von einem Fachunternehmen warten.</li> </ul>
<p>Einmal jährlich</p>	<ul style="list-style-type: none"> <li>Prüfen Sie die Dichtungen zwischen der Dachklimaanlage und dem Fahrzeugdach auf Risse und andere Beschädigungen.</li> <li>Prüfen Sie, ob die Befestigungsschrauben auf das richtige Anzugsmoment (2,5 Nm <math>\pm</math> 0,3 Nm) angezogen sind und justieren Sie bei Bedarf nach.</li> </ul>

## 12 Fehlersuche und Fehlerbehebung

Problem	Mögliche Ursache	Lösungsvorschlag
<p>Die Kühlleistung ist zu schwach</p>	<p>Die Dachklimaanlage ist nicht auf den Kühlbetrieb eingestellt.</p>	<p>Stellen Sie die Dachklimaanlage auf den Kühlbetrieb ein.</p>
	<p>Die Umgebungstemperatur liegt über 52 °C.</p>	<p>Die Dachklimaanlage ist nur für eine Umgebungstemperatur bis 52 °C ausgelegt.</p>
	<p>Die eingestellte Temperatur ist höher als die Raumtemperatur.</p>	<p>Wählen Sie eine niedrigere Temperatur.</p>
	<p>Die Umgebungstemperatur liegt unter 16 °C.</p>	<p>Die Dachklimaanlage ist nur bei Umgebungstemperaturen über 16 °C auf einen Kühlbetrieb ausgelegt.</p>
	<p>Einer der Temperaturfühler ist defekt.</p>	<p>Wenden Sie sich an einen autorisierte Kundendienstbetrieb oder an Dometic.</p>
	<p>Der Verdampferlüfter ist schadhaft.</p>	<p>Wenden Sie sich an einen autorisierte Kundendienstbetrieb oder an Dometic.</p>

Problem	Mögliche Ursache	Lösungsvorschlag
	Der Kondensatorlüfter ist schadhaft.	Wenden Sie sich an einen autorisierte Kundendienstbetrieb oder an Dometic.
<b>Nur FreshJet FJX4233EEH/ FJX4333E(EH)/FJX7333IHP/ FJX7337IHP/FJX7457IHP:</b> Die Heizleistung ist zu schwach	Die Dachklimaanlage ist nicht auf den Heizbetrieb eingestellt.	Stellen Sie die Dachklimaanlage auf den Heizbetrieb ein.
	Die Umgebungstemperatur liegt unter $-2\text{ }^{\circ}\text{C}$ .	Die Dachklimaanlage ist für Umgebungstemperaturen über $-2\text{ }^{\circ}\text{C}$ ausgelegt.
	Die eingestellte Temperatur ist niedriger als die Raumtemperatur.	Wählen Sie eine höhere Temperatur.
	Einer der Temperaturfühler ist defekt.	Wenden Sie sich an einen autorisierte Kundendienstbetrieb oder an Dometic.
	Der Verdampferlüfter ist schadhaft.	Wenden Sie sich an einen autorisierte Kundendienstbetrieb oder an Dometic.
Die Lüfterleistung ist schwach.	Die Luftansaugöffnungen sind blockiert oder verdeckt.	Entfernen Sie Laub und anderen Schmutz von den Lüftungsgittern der Dachklimaanlage.
	Der Lüfter ist defekt.	Wenden Sie sich an einen autorisierte Kundendienstbetrieb oder an Dometic.
Wassereintritt im Fahrzeug	Die Ablauföffnungen für Kondenswasser sind verstopft.	Reinigen Sie die Wasserablauföffnungen von Kondenswasser.
	Die Dichtungen sind schadhaft.	Wenden Sie sich an einen autorisierte Kundendienstbetrieb oder an Dometic.
Die Dachklimaanlage schaltet sich nicht ein.	Es ist keine Stromversorgung angeschlossen.	Prüfen Sie die Stromzufuhr.
	Die Spannung ist zu niedrig ( $< 200\text{ V}$ ).	Wenden Sie sich an einen autorisierte Kundendienstbetrieb oder an Dometic.
	Der Spannungswandler ist defekt.	Wenden Sie sich an einen autorisierte Kundendienstbetrieb oder an Dometic.
	Einer der Temperaturfühler ist defekt.	Wenden Sie sich an einen autorisierte Kundendienstbetrieb oder an Dometic.
	Die elektrische Absicherung der Stromversorgung ist zu gering.	Wenden Sie sich an einen autorisierte Kundendienstbetrieb oder an Dometic.
Die Dachklimaanlage schaltet sich nicht ab.	Einer der Temperaturfühler ist defekt.	Wenden Sie sich an einen autorisierte Kundendienstbetrieb oder an Dometic.
	Die elektrische Absicherung der Stromversorgung ist zu gering.	Wenden Sie sich an einen autorisierte Kundendienstbetrieb oder an Dometic.
<b>Nur FreshJet FJX4233EEH/ FJX4333E(EH)/FJX7333IHP/ FJX7337IHP/FJX7457IHP:</b> Die Dachklimaanlage schaltet sich ständig ab.	Der Vereisungssensor hat ausgelöst.	Die Außentemperatur ist zu niedrig oder alle Luftdüsen sind geschlossen.

<b>Problem</b>	<b>Mögliche Ursache</b>	<b>Lösungsvorschlag</b>
Das Display zeigt: P0	Übertemperatur oder Überstrom am IPM-Modul	Wenden Sie sich an einen autorisierte Kundendienstbetrieb oder an Dometic.
Das Display zeigt: P1	Unterspannungsschutz	Wenden Sie sich an einen autorisierte Kundendienstbetrieb oder an Dometic.
Das Display zeigt: P2	Wechselstrom-Überstromschutz des Geräts	Wenden Sie sich an einen autorisierte Kundendienstbetrieb oder an Dometic.
Das Display zeigt: P4	Überhitzungsschutz für Auslassrohr	Wenden Sie sich an einen autorisierte Kundendienstbetrieb oder an Dometic.
Das Display zeigt: P5	Verdampferspulenschutz (Kühlbetrieb)	Wenden Sie sich an einen autorisierte Kundendienstbetrieb oder an Dometic.
Das Display zeigt: P6	Kondensatorspulenschutz (Kühlbetrieb)	Wenden Sie sich an einen autorisierte Kundendienstbetrieb oder an Dometic.
Das Display zeigt: P7	Verdampferspulenschutz (Heizbetrieb)	Wenden Sie sich an einen autorisierte Kundendienstbetrieb oder an Dometic.
Das Display zeigt: P9	Kompressorantrieb anormal oder Kompressor startet nicht	Wenden Sie sich an einen autorisierte Kundendienstbetrieb oder an Dometic.
Das Display zeigt: E0	Kommunikationsfehler	Wenden Sie sich an einen autorisierte Kundendienstbetrieb oder an Dometic.
Das Display zeigt: E1	Störung Raumtemperatursensor	Wenden Sie sich an einen autorisierte Kundendienstbetrieb oder an Dometic.
Das Display zeigt: E2	Störung Temperatursensor der Verdampferspule	Wenden Sie sich an einen autorisierte Kundendienstbetrieb oder an Dometic.
Das Display zeigt: E3	Störung Temperatursensor der Kondensatorspule	Wenden Sie sich an einen autorisierte Kundendienstbetrieb oder an Dometic.
Das Display zeigt: E7	Ausfall Außentemperatursensor	Wenden Sie sich an einen autorisierte Kundendienstbetrieb oder an Dometic.
Das Display zeigt: E8	Ausfall Temperatursensor für Auslassrohr	Wenden Sie sich an einen autorisierte Kundendienstbetrieb oder an Dometic.
Das Display zeigt: E9	Störung Kompressorantrieb oder IPM-Modul	Wenden Sie sich an einen autorisierte Kundendienstbetrieb oder an Dometic.
Das Display zeigt: EA	Störung Stromsensor	Wenden Sie sich an einen autorisierte Kundendienstbetrieb oder an Dometic.
Das Display zeigt: EE	Störung EEPROM Außenbereich	Wenden Sie sich an einen autorisierte Kundendienstbetrieb oder an Dometic.
Das Display zeigt: EL	Kommunikationsfehler LIN-BUS/CI-BUS	Wenden Sie sich an einen autorisierte Kundendienstbetrieb oder an Dometic.

## 13 Entsorgung



Geben Sie das Verpackungsmaterial möglichst in den entsprechenden Recycling-Müll. Wenden Sie sich an ein örtliches Recyclingzentrum oder einen Fachhändler, um zu erfahren, wie Sie das Produkt gemäß den geltenden Entsorgungsvorschriften entsorgen können.



Schützen Sie Ihre Umwelt! Akkus und Batterien gehören nicht in den Hausmüll. Geben Sie bitte Ihre defekten Akkus oder verbrauchten Batterien beim Händler oder bei einer Sammelstelle ab.

## 14 Garantie

Es gilt die gesetzliche Gewährleistungsfrist. Sollte das Produkt defekt sein, wenden Sie sich bitte an die Niederlassung des Herstellers in Ihrem Land (siehe [dometic.com/dealer](http://dometic.com/dealer)) oder an Ihren Fachhändler.

Bitte senden Sie bei einem Reparatur- bzw. Gewährleistungsantrag folgende Unterlagen mit dem Produkt ein:

- eine Kopie der Rechnung mit Kaufdatum
- einen Reklamationsgrund oder eine Fehlerbeschreibung

Bitte beachten Sie, dass eigenständig oder nicht fachgerecht durchgeführte Reparaturen die Sicherheit gefährden und zum Erlöschen der Garantie führen können.

## 15 Technische Daten

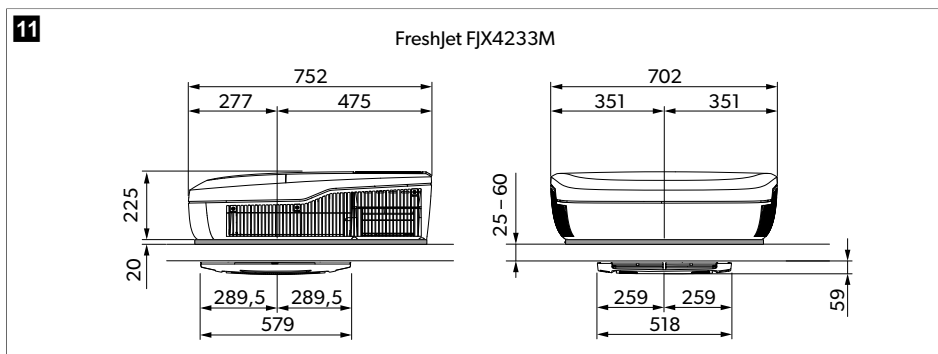

12

FJX4233EEH, FJX4333E(EH), FJX7333IHP

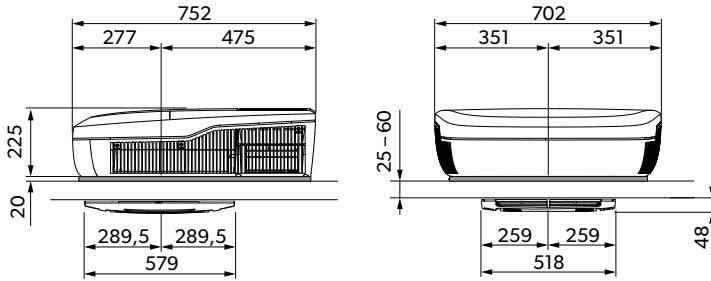

13

FreshJet FJX7337IHP

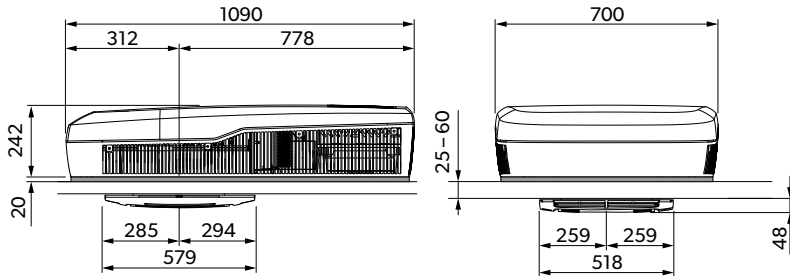

14

FreshJet FJX7457IHP

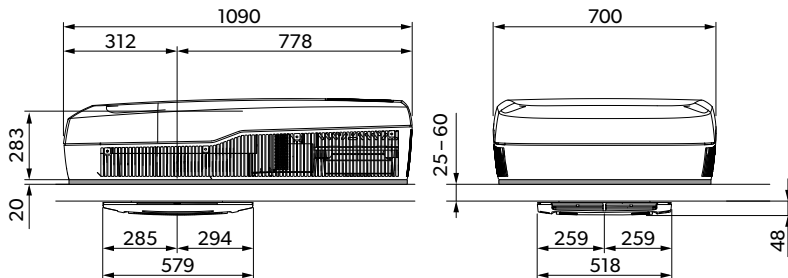

Enthält fluorierte Treibhausgase. Hermetisch geschlossene Vorrichtung.

	<b>FreshJet FJX4233M</b>
Kühlleistung in Anlehnung an ISO 5151:	1500 W
Eingangswechselspannung:	220 V ... 240 V / 50 Hz

	<b>FreshJet FJX4233M</b>
Nennstrom Kühlung:	< 3.3 A
Benötigte Sicherung:	4 A
Betriebstemperaturbereich:	- 2 °C ... 52 °C
Kühlmittel:	R410a
Kühlmittelmenge:	380 g
CO <sub>2</sub> -Äquivalent:	0.793 t
Treibhauspotential (GWP):	2088
Schutzklasse (Dachklimaanlage):	IPX4
Geräuschpegel (höchste Lüfterstufe)	< 70 dB(A)
Vorgeschlagene maximale Fahrzeuglänge (mit isolierten Wänden):	< 5 m
Abmessungen L x B x H:	Abb. <b>11</b> auf Seite 53
Gewicht:	< 30 kg
Prüfung/Zertifikat:	

	<b>FreshJet FJX4233EEH</b>	<b>FreshJet FJX4333EEH</b>	<b>FreshJet FJX4333E</b>
Kühlleistung in Anlehnung an ISO 5151:	1700 W	2200 W	2200 W
Heizleistung in Anlehnung an ISO 5151:	800 W	1000 W	-
Eingangswchselspannung:	220 V ... 240 V / 50 Hz		
Nennstrom Kühlung:	3.6 A	4.8 A	4.8 A
Nennstrom Heizung:	< 5.2 A	< 5.2 A	-
Benötigte Sicherung:	4 A	5 A	6 A
Betriebstemperaturbereich:	- 2 °C ... 52 °C		
Kühlmittel:	R32		
Kühlmittelmenge:	320 g	360 g	360 g

	<b>FreshJet FJX4233EEH</b>	<b>FreshJet FJX4333EEH</b>	<b>FreshJet FJX4333E</b>
CO <sub>2</sub> -Äquivalent:	0.216 t	0.243 t	0.243 t
Treibhauspotential (GWP):	675		
Schutzklasse (Dachklimaanlage):	IPX4		
Geräuschpegel (höchste Lüfterstufe)	< 70 dB(A)		
Vorgeschlagene maximale Fahrzeuglänge (mit isolierten Wänden):	< 6 m	< 7 m	< 7 m
Abmessungen L x B x H:	Abb. <b>12</b> auf Seite 54		
Gewicht:	< 30 kg	< 30 kg	< 30 kg
Prüfung/Zertifikat:			

	<b>FreshJet FJX7333IHP</b>	<b>FreshJet FJX7337IHP</b>	<b>FreshJet FJX7457IHP</b>
Kühlleistung in Anlehnung an ISO 5151:	2200 W	3000 W	3500 W
Heizleistung in Anlehnung an ISO 5151:	2000 W	2500 W	3000 W
Eingangsschaltspannung:	220 V ... 240 V / 50 Hz ... 60 Hz	220 V ... 240 V / 50 Hz ... 60 Hz	220 V ... 240 V / 50 Hz ... 60 Hz
Nennstrom Kühlung:	< 7.5 A	< 7.5 A	< 7.5 A
Nennstrom Heizung:	< 6.1 A	< 6.1 A	< 6.1 A
Benötigte Sicherung:	6 A	6 A	6 A
Betriebstemperaturbereich:	- 2 °C ... 52 °C	- 2 °C ... 52 °C	- 2 °C ... 52 °C
Kühlmittel:	R32	R32	R32
Kühlmittelmenge:	420 g	480 g	650 g
CO <sub>2</sub> -Äquivalent:	0.2835 t	0.3240 t	0.43875 t
Treibhauspotential (GWP):	675		
Schutzklasse (Dachklimaanlage):	IPX4		
Geräuschpegel (höchste Lüfterstufe)	< 70 dB(A)		



	<b>FreshJet FJX7333IHP</b>	<b>FreshJet FJX7337IHP</b>	<b>FreshJet FJX7457IHP</b>
Vorgeschlagene maximale Fahrzeuglänge (mit isolierten Wänden):	< 7 m	< 7 m	> 8 m
Abmessungen L x B x H:	Abb. <b>12</b> auf Seite 54	Abb. <b>13</b> auf Seite 54	Abb. <b>14</b> auf Seite 54
Gewicht:	< 30 kg	< 35 kg	< 40 kg
Prüfung/Zertifikat:			

## French

1	Important notes.....	58
2	Signification des symboles.....	58
3	Consignes de sécurité.....	59
4	Usage conforme.....	60
5	Description des symboles de l'appareil.....	61
6	Limites et conditions techniques.....	61
7	Description technique.....	61
8	Avant la première utilisation.....	67
9	Utilisation.....	67
10	Nettoyage du climatiseur de toit.....	75
11	Maintenance.....	75
12	Dépannage.....	77
13	Mise au rebut.....	80
14	Garantie.....	80
15	Caractéristiques techniques.....	80

## 1 Important notes

Veuillez lire et suivre attentivement l'ensemble des instructions, directives et avertissements figurant dans ce manuel afin d'installer, d'utiliser et d'entretenir le produit correctement à tout moment. Ces instructions DOIVENT rester avec le produit.

En utilisant ce produit, vous confirmez expressément avoir lu attentivement l'ensemble des instructions, directives et avertissements et que vous comprenez et acceptez de respecter les modalités et conditions énoncées dans le présent document. Vous acceptez d'utiliser ce produit uniquement pour l'usage et l'application prévus et conformément aux instructions, directives et avertissements figurant dans le présent manuel, ainsi qu'à toutes les lois et réglementations applicables. En cas de non-respect des instructions et avertissements figurant dans ce manuel, vous risquez de vous blesser ou de blesser d'autres personnes, d'endommager votre produit ou d'endommager d'autres biens à proximité. Le présent manuel produit, y compris les instructions, directives et avertissements, ainsi que la documentation associée peuvent faire l'objet de modifications et de mises à jour. Pour obtenir des informations actualisées sur le produit, consulter le site [documents.dometic.com](http://documents.dometic.com).

## 2 Signification des symboles



**DANGER !** indiquent une situation dangereuse qui, si elle n'est pas évitée, entraînera des blessures graves, voire mortelles.



**AVERTISSEMENT !** indiquent une situation dangereuse qui, si elle n'est pas évitée, entraînera des blessures graves, voire mortelles.



**ATTENTION !** indiquent une situation dangereuse qui, si elle n'est pas évitée, est susceptible d'entraîner des blessures légères ou de gravité modérée.



**AVIS !** indiquent une situation dangereuse qui, si elle n'est pas évitée, est susceptible d'entraîner des blessures légères ou de gravité modérée.



**Remarque** Informations complémentaires sur l'utilisation de ce produit.

### 3 Consignes de sécurité



**AVERTISSEMENT ! Le non-respect de ces mises en garde peut entraîner des blessures graves, voire mortelles.**

- **Les appareils électriques ne sont pas des jouets pour enfants.** L'appareil ne doit pas être utilisé par des personnes (y compris des enfants) dont les capacités physiques, sensorielles ou mentales sont réduites, ou qui manquent d'expérience et de connaissances, à moins qu'elles ne soient sous surveillance ou qu'elles n'aient reçu des instructions.
- Les enfants doivent être surveillés pour garantir qu'ils ne jouent pas avec l'appareil.
- Cet appareil peut être utilisé par des enfants âgés de 8 ans et plus et des personnes ayant des capacités physiques, sensorielles ou mentales réduites ou un manque d'expérience et de connaissances, s'ils sont sous surveillance ou ont reçu des instructions sur l'utilisation de l'appareil en toute sécurité et comprennent les risques impliqués.
- Le nettoyage ne doit pas être effectué par des enfants sans surveillance.
- Toute personne impliquée dans une intervention sur un circuit frigorifique ou son ouverture doit détenir un certificat en cours de validité délivré par un organisme de contrôle agréé attestant sa capacité à manipuler les fluides frigorigènes en toute sécurité conformément à une spécification d'évaluation sectorielle.
- La maintenance doit uniquement être effectuée selon les recommandations du fabricant de l'équipement. La maintenance et les réparations nécessitant l'aide de personnel qualifié tiers doivent être effectuées sous la supervision de la personne compétente en matière d'utilisation de fluides frigorigènes inflammables.
- Seul un personnel qualifié et parfaitement informé des dangers et règlements spécifiques à ces manipulations est habilité à effectuer des réparations sur cet appareil. Toute réparation inappropriée risque d'entraîner de graves dangers. Pour tout service de réparation, contactez le centre d'entretien de votre pays (voir [dometic.com/dealer](http://dometic.com/dealer)).
- Coupez toujours l'alimentation électrique au cours de travaux sur l'appareil.
- L'appareil doit être stocké dans un local exempt de source d'ignition continue (par exemple : flammes nues, appareil à gaz en fonctionnement ou chauffage électrique en fonctionnement).
- Ne percez ou ne brûlez pas l'appareil.
- Notez que les réfrigérants peuvent ne pas avoir d'odeur.
- N'utilisez pas l'appareil à proximité de liquides inflammables ou dans des pièces fermées.
- Assurez-vous qu'aucun objet inflammable n'est entreposé ni installé à proximité de l'échappement. Une distance d'au moins 50 cm doit être observée.
- Veillez à ce que les orifices de ventilation ne soient pas obstrués.
- N'endommagez pas le circuit frigorifique.
- En aucun cas des sources d'ignition potentielles ne doivent être utilisées pour rechercher ou détecter des fuites de fluide frigorigène. N'utilisez pas de lampe halogène (ou tout autre détecteur utilisant une flamme nue).
- Le climatiseur de toit doit être installé dans un véhicule dont la surface au sol est supérieure à 4 m<sup>2</sup>.



### **ATTENTION ! Le non-respect de ces mises en garde peut entraîner des blessures légères ou de gravité modérée.**

- Ne glissez pas vos doigts dans les échappements et n'introduisez aucun objet à l'intérieur de l'appareil.
- En cas, d'incendie, ne retirez pas le cache supérieur de l'appareil. Utilisez plutôt des agents d'extinction agréés. N'essayez pas d'éteindre l'incendie avec de l'eau.
- Si le cordon d'alimentation est endommagé, il doit être remplacé par le fabricant, son agent de service ou tout autre personnel qualifié afin d'éviter tout danger.
- Si l'appareil contient un ioniseur, consultez votre médecin en cas de problème médical. L'ioniseur peut produire de l'ozone (O3) en petites quantités. Si vous souffrez d'une maladie pulmonaire, d'asthme, d'une maladie cardiaque, d'une maladie respiratoire, de problèmes respiratoires, ou si vous êtes sensible à l'ozone, consultez votre médecin pour déterminer si l'utilisation de cet appareil est sans danger pour vous.



### **AVIS ! Risque d'endommagement**

- N'utilisez pour accélérer le processus de dégivrage ou pour le nettoyage aucun autre moyen que ceux recommandés par le fabricant.
- L'appareil doit être stocké de manière à éviter tout dommage mécanique.
- Ne procédez à aucune modification ni transformation de l'appareil !
- Si l'appareil est installé sur votre véhicule, ne le lavez jamais dans une station de lavage automatique.
- En cas de défaut dans le circuit frigorifique, l'appareil doit être vérifié et réparé par le fabricant, son agent de service ou un personnel qualifié afin d'éviter tout danger.

## **4 Usage conforme**

Le climatiseur de toit FreshJet FJX est conçu pour être installé uniquement sur le toit d'une caravane ou d'un camping-car à des fins de refroidissement.

Le climatiseur de toit **n'est pas** adapté aux trains, maisons et appartements. Le climatiseur de toit ne convient **pas** aux engins de construction, aux machines agricoles ou autres engins de travail similaires.

Ce produit convient uniquement à l'usage et à l'application prévus, conformément au présent manuel d'instructions.

Ce manuel fournit les informations nécessaires à l'installation et/ou à l'utilisation correcte du produit. Une installation, une utilisation ou un entretien inappropriés entraînera des performances insatisfaisantes et une éventuelle défaillance.

Le fabricant décline toute responsabilité en cas de blessure ou de dommage résultant :

- d'un montage ou d'un raccordement incorrect, y compris d'une surtension
- d'un entretien inadéquat ou de l'utilisation de pièces de rechange autres que les pièces de rechange d'origine fournies par le fabricant
- de modifications apportées au produit sans autorisation explicite du fabricant
- d'usages différents de ceux décrits dans ce manuel.

Dometic se réserve le droit de modifier l'apparence et les spécifications produit.

## 5 Description des symboles de l'appareil



Attention ! Matériau à combustion lente.



Consultez le manuel d'utilisation.



Consultez le manuel de service.

## 6 Limites et conditions techniques

Le climatiseur de toit est conçu pour les véhicules dotés d'un toit d'une épaisseur de 25 mm ... 60 mm. Le fonctionnement du climatiseur de toit est garanti pour les températures ambiantes comprises entre  $-2^{\circ}\text{C}$  ...  $52^{\circ}\text{C}$ . Le climatiseur de toit est conçu pour être installé à  $\pm 10^{\circ}$  du plan horizontal. Les performances du climatiseur de toit peuvent être réduites lorsqu'il est exposé à de fortes vibrations, par exemple en raison de mauvaises conditions routières.

## 7 Description technique

Le climatiseur de toit FreshJet FJX4233M diffuse de l'air frais pouvant être déshumidifié à l'intérieur du véhicule, sans poussière ni saleté.

Les climatiseurs de toit FreshJet FJX4233EEH/FJX4333E(EH)/FJX7333IHP/FJX7337IHP/FJX7457IHP diffusent de l'air froid ou chaud pouvant être déshumidifié à l'intérieur du véhicule, sans poussière ni saleté.

Le climatiseur de toit peut abaisser la température à l'intérieur du véhicule à un certain niveau selon le type de véhicule, la température ambiante et la capacité de refroidissement du climatiseur de toit. En dessous d'une température extérieure de  $16^{\circ}\text{C}$ , le climatiseur de toit ne refroidit plus.

Le climatiseur de toit fonctionne avec les éléments de commande suivants :

- Panneau de commande

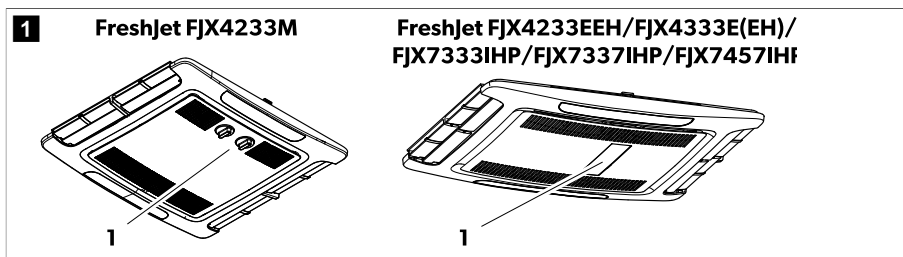

- Télécommande (uniquement pour les modèles FJX4233EEH/FJX4333E(EH)/FJX7333IHP/FJX7337IHP/FJX7457IHP)

## 7.1 Liste des modèles

Le tableau suivant référence les différentes fonctions et modèles correspondants :

● La fonctionnalité est disponible

○ La fonctionnalité peut être mise à niveau

	FJX4233M	FJX4233EEH	FJX4333EEH	FJX4333E	FJX7333IHP	FJX7337IHP	FJX7457IHP
Automatique		●	●	●	●	●	●
Refroidissement	●	●	●	●	●	●	●
Chauffage		●	●	○	●	●	●
Ventilation	●	●	●	●	●	●	●
Déshumidification		●	●	●	●	●	●
Purificateur d'air	○	●	●	○	●	●	●
Lampe à ADB		●	●	○	●	●	●
Éclairage extérieur					●	●	●
Minuterie		●	●	●	●	●	●
Sommeil		●	●	●	●	●	●
Soft Start			●	○	●	●	●

## 7.2 Panneau de commande du modèle FreshJet FJX4233M

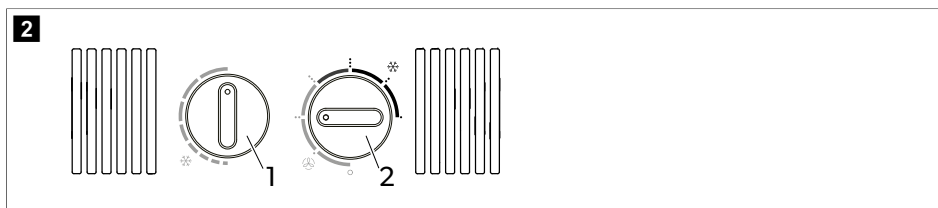





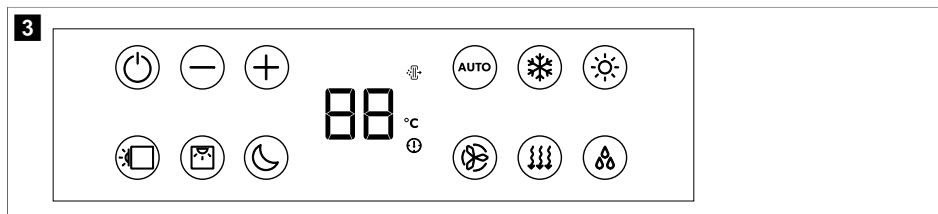

Bouton rotatif	Description
	Permet de régler la température. Tournez le bouton dans le sens des aiguilles d'une montre pour augmenter le refroidissement.

Bouton rotatif	Description
	Active ou désactive le climatiseur de toit et sélectionne l'intensité de la circulation d'air en mode Ventilation (☼) ou l'intensité de refroidissement en mode Refroidissement (❄️).

### 7.3 Panneau de commande FreshJet FJX4233EEH/FJX4333E(EH)/FJX7333IHP/FJX7337IHP/FJX7457IHP



Symbole	Description
	Met le climatiseur de toit en marche ou en mode Veille.
	augmentation de la valeur affichée.
	réduction de la valeur affichée.
	Couplage via Bluetooth/WLAN lorsque les deux boutons sont actionnés simultanément.
	Allume ou éteint l'éclairage ambiant dans l'unité de toit.
	Allume ou éteint l'éclairage ambiant dans le caisson de distribution d'air.
	Activation de la fonction sommeil (Fonctions supplémentaires (uniquement pour les modèles FJX4233EEH/FJX4333E(EH)/FJX7333IHP/FJX7337IHP/FJX7457IHP) à la page 66).
	Affichage de la température réglée et indication du niveau du ventilateur lorsque celui-ci est réglé.
	Indique que le mode Purificateur d'air est actif.
	Indique que la température est affichée en degrés Celsius.
	Indication que la minuterie est activée.
	Active/désactive le mode Automatique (Modes de climatisation (uniquement pour les modèles FJX4233EEH/FJX4333E(EH)/FJX7333IHP/FJX7337IHP/FJX7457IHP) à la page 66).
	Active/désactive le mode Refroidissement (Modes de climatisation (uniquement pour les modèles FJX4233EEH/FJX4333E(EH)/FJX7333IHP/FJX7337IHP/FJX7457IHP) à la page 66).

















Symbole	Description
	Active/désactive le mode Chauffage (Modes de climatisation (uniquement pour les modèles FJX4233EEH/FJX4333E(EH)/FJX7333IHP/FJX7337IHP/FJX7457IHP) à la page 66).
	Définit la vitesse du ventilateur sur le réglage Faible, Intermédiaire, Élevée, Turbo ou Automatique (indiqué par 1, 2, 3, 4 ou A pendant une courte période lors du changement sur l'écran du caisson de distribution d'air).
	Activation/désactivation du mode ventilation (Modes de climatisation (uniquement pour les modèles FJX4233EEH/FJX4333E(EH)/FJX7333IHP/FJX7337IHP/FJX7457IHP) à la page 66). Circulation de l'air sans chauffage ni refroidissement.
	Activation/désactivation du mode déshumidification (Modes de climatisation (uniquement pour les modèles FJX4233EEH/FJX4333E(EH)/FJX7333IHP/FJX7337IHP/FJX7457IHP) à la page 66).

## 7.4 Télécommande des modèles FreshJet FJX4233EEH/FJX4333E(EH)/FJX7333IHP/FJX7337IHP/FJX7457IHP





Éléments de commande et d'affichage fig. **4** à la page 64 :



Touche	Description
—	<p><b>Écran</b></p> <p>Affichage des informations suivantes :</p> <ul style="list-style-type: none"> <li>• heure</li> <li>• Température ambiante sélectionnée (valeur de consigne) en °C</li> <li>• température ambiante effective</li> <li>• Mode de climatisation</li> <li>• Vitesse de ventilation</li> <li>• Symboles des fonctions supplémentaires actives</li> <li>• état de la batterie</li> </ul>
	Mise en marche ou passage en mode veille du climatiseur de toit.
	augmentation de la valeur affichée.
	réduction de la valeur affichée.
	Permet de sélectionner la vitesse du ventilateur (Sélection manuelle de la vitesse du ventilateur à la page 70).
	Sélection du mode de climatisation (Modes de climatisation (uniquement pour les modèles FJX4233EEH/FJX4333E(EH)/FJX7333IHP/FJX7337IHP/FJX7457IHP) à la page 66). Le symbole correspondant s'affiche.
	Activation de la fonction sommeil (Fonctions supplémentaires (uniquement pour les modèles FJX4233EEH/FJX4333E(EH)/FJX7333IHP/FJX7337IHP/FJX7457IHP) à la page 66). Le symbole  s'affiche.
	Confirme et enregistre les paramètres.
	Permet de régler la minuterie et l'horloge.
	Allume ou éteint l'éclairage ambiant dans le caisson de distribution d'air.
	Appuyez une fois pour afficher la température intérieure actuelle. Le symbole  s'affiche. Appuyez deux fois pour afficher la température définie.
	Active de la fonction Détection. Le symbole  s'affiche. Toutes les 10 min, la fonction Détection ajuste la température de consigne à la température réelle mesurée par la télécommande.
	Allume ou éteint l'éclairage ambiant dans l'unité de toit.
	Indique que les piles de la télécommande sont vides. Changez les piles (Remplacement des piles de la télécommande à la page 73).
	Indique que la télécommande transmet des valeurs au climatiseur de toit.





## 7.5 Modes de climatisation (modèle FJX4233M uniquement)

Le climatiseur de toit dispose des modes de climatisation suivants :

Mode de climatisation	Symboles affichés	Description
Refroidissement		Une fois les réglages de température et de ventilation définis, le climatiseur de toit refroidit l'habitacle à cette température.
Ventilation		Une fois les réglages du ventilateur définis, le climatiseur de toit fait circuler l'air sans chauffage ni refroidissement.





## 7.6 Modes de climatisation (uniquement pour les modèles FJX4233EEH/FJX4333E(EH)/FJX7333IHP/FJX7337IHP/FJX7457IHP)

Le climatiseur de toit dispose des modes de climatisation suivants :

Mode de climatisation	Symboles affichés	Description
Automatique	<b>A</b>	Une fois la température réglée, le climatiseur de toit amène l'habitacle à cette température en chauffant ou en refroidissant et en réglant la vitesse de ventilation nécessaire.
Refroidissement		Une fois les réglages de température et de ventilation définis, le climatiseur de toit refroidit l'habitacle à cette température.
Chauffage		<b>Excepté pour le modèle FJX4333E :</b> Une fois les réglages de température et de ventilation définis, le climatiseur de toit chauffe l'habitacle à cette température. Le ventilateur ne démarre qu'après 2 min (vitesse faible), puis au bout d'environ 5 min, passe à la vitesse réglée (une fois que l'évaporateur a atteint la température).
Ventilation		Une fois les réglages du ventilateur définis, le climatiseur de toit fait circuler l'air sans chauffage ni refroidissement.
Déshumidification de l'air		Le climatiseur de toit élimine l'humidité de l'air sans chauffer ou refroidir l'intérieur, ce qui réduit l'humidité relative de l'air.
Purificateur d'air		<b>Excepté pour le modèle FJX4333E :</b> Le climatiseur de toit ionise l'air, recueillant ainsi la poussière et les particules qu'il contient, y compris les virus et les bactéries.

## 7.7 Fonctions supplémentaires (uniquement pour les modèles FJX4233EEH/FJX4333E(EH)/FJX7333IHP/FJX7337IHP/FJX7457IHP)

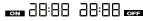
Le climatiseur de toit dispose des fonctions supplémentaires suivantes :

Fonctions supplémentaires	Affichage à l'écran	Description
Minuterie		Le climatiseur de toit se met en marche à l'heure spécifiée.
		Le climatiseur de toit s'arrête à l'heure spécifiée.
		Le climatiseur de toit se met en marche et s'arrête aux heures spécifiées.
Sommeil		La fonction Sommeil limite la vitesse du ventilateur et du compresseur afin de réduire le niveau sonore pour un meilleur confort de sommeil.
Détection		La télécommande mesure la température ambiante et transmet cette mesure au climatiseur de toit toutes les 10 min. Le climatiseur de toit adapte la valeur cible à cette mesure.
Soft Start		<b>Excepté pour le modèle FJX4233EEH :</b> Le courant de crête produit par le démarrage du compresseur est réduit par la fonction de démarrage progressif. Si un générateur est utilisé comme alimentation, il ne sera pas surchargé.

## 8 Avant la première utilisation

### Contrôles avant la mise en service

Avant de mettre en marche le climatiseur de toit, observez les consignes suivantes :

1. Assurez-vous que la tension et la fréquence d'alimentation correspondent aux valeurs spécifiées dans Caractéristiques techniques à la page 80.
2. Assurez-vous que les orifices d'aspiration et les buses de ventilation ne sont pas obstrués. Les grilles d'aération doivent toujours être dégagées pour que le climatiseur de toit puisse fonctionner à sa capacité maximale.

### Préparez la télécommande (uniquement pour les modèles FreshJet FJX4233EEH/FJX4333E(EH)/FJX7333IHP/FJX7337IHP/FJX7457IHP)

3. Insérez les piles (Remplacement des piles de la télécommande à la page 73).

### Réglez l'heure (uniquement pour les modèles FreshJet FJX4233EEH/FJX4333E(EH)/FJX7333IHP/FJX7337IHP/FJX7457IHP)

4. Réglage de l'heure actuelle (Réglage de l'heure actuelle à la page 70).

## 9 Utilisation

### 9.1 Conseils pour optimiser l'utilisation de l'appareil

Les conseils suivants vous permettront d'optimiser le fonctionnement de votre climatiseur de toit :

- Améliorez l'isolation thermique du véhicule en colmatant les fentes et en suspendant des volets roulants réfléchissants ou des rideaux devant les fenêtres.
- Choisissez une température et une vitesse de ventilation appropriées.

- Orientez les buses de ventilation de manière pertinente.
- Assurez-vous que les buses d'aération et les orifices d'aspiration ne sont pas couverts par des vêtements, du papier ou tout autre objet.
- **Uniquement pour les modèles FreshJet FJX4233EEH/FJX4333E(EH)/FJX7333IHP/FJX7337IHP/FJX7457IHP** : Si le véhicule est resté en plein soleil pour une durée prolongée : Faites fonctionner le climatiseur de toit en mode Ventilation (🌀) avec les fenêtres ouvertes pendant un certain temps avant d'activer le mode Refroidissement (❄️).
- **Uniquement pour les modèles FreshJet FJX4233EEH/FJX4333E(EH)/FJX7333IHP/FJX7337IHP/FJX7457IHP** : Dans la mesure du possible, évitez d'ouvrir les portes et les fenêtres en mode Refroidissement (❄️).

## 9.2 Remarques générales concernant l'utilisation

Le climatiseur de toit FreshJet FJX4233M dispose de trois modes de fonctionnement :

Mode de fonctionnement	Description
Arrêt	Le climatiseur est éteint.
Refroidissement	Le climatiseur de toit refroidit l'intérieur.
Ventilation	Le climatiseur de toit fait circuler l'air sans refroidissement.

Le climatiseur de toit FreshJet FJX4233EEH/FJX4333E(EH)/FJX7333IHP/FJX7337IHP/FJX7457IHP dispose de deux modes de fonctionnement :

Mode de fonctionnement	Description
Veille	Le climatiseur de toit est prêt à fonctionner et peut être mis en marche à l'aide de la télécommande. Les lumières d'ambiance sont disponibles. La télécommande est également en veille, mais vous pouvez l'activer indépendamment du climatiseur de toit.
Marche	Le climatiseur de toit climatise l'habitacle.

## 9.3 Modèle Dometic FJX4233M

Les informations fournies dans ce chapitre s'appliquent uniquement aux climatiseurs de toit FJX4233M.

### 9.3.1 Mise en marche et arrêt du climatiseur de toit

Le climatiseur de toit dispose de deux modes de climatisation :

- Mode Ventilation (🌀)
- Mode Refroidissement (❄️)



**Remarque** Attendez au moins 30 s avant de passer du mode Ventilation au mode Refroidissement ou inversement. Sinon, le courant de commutation peut griller le fusible.

Chaque mode dispose de trois réglages :

- .. : Basse
- ... : Moyen
- .... : Élevée

>

Pour l'allumer l'appareil, tournez le bouton  sur la position Ventilation () ou Refroidissement () et choisissez le réglage souhaité.

✓ Le climatiseur de toit est en marche et fonctionne avec les valeurs définies avant son arrêt.

>

Pour éteindre l'appareil, tournez le bouton  sur la position 0.

### 9.3.2 Réglage de la température

>

Tournez le bouton  dans la position souhaitée. Tournez le bouton dans le sens des aiguilles d'une montre pour baisser la température.

✓ La température est réglée dans le climatiseur de toit.

## 9.4 FreshJet FJX4233EEH/FJX4333E(EH)/FJX7333IHP/FJX7337IHP/FJX7457IHP

Les informations fournies dans ce chapitre s'appliquent uniquement aux climatiseurs de toit FreshJet FJX4233EEH/FJX4333E(EH)/FJX7333IHP/FJX7337IHP/FJX7457IHP.

### 9.4.1 Avec la télécommande



Tenez compte des conseils suivants lorsque vous utilisez la télécommande :

- Orientez la télécommande vers le récepteur infrarouge du panneau de commande.
  - Les réglages et valeurs correspondants sont transmis directement au climatiseur de toit lorsque vous appuyez sur un bouton.
  - Le climatiseur de toit confirme la réception des données par un signal sonore.
  - Les valeurs augmentent ou diminuent plus rapidement lorsque vous maintenez la touche + ou – enfoncée.
  - En mode veille, l'écran de la télécommande est également inactif. La télécommande peut être mise en veille indépendamment du climatiseur de toit.
- > Pour mettre uniquement la télécommande en mode Veille, appuyez sur la touche  sans l'orienter vers le récepteur infrarouge du panneau de commande.

### 9.4.2 Mise en marche ou en veille du climatiseur de toit



**Remarque** Lorsque le climatiseur de toit se met en marche, il fonctionne avec les valeurs définies avant sa mise en veille. Le climatiseur de toit peut uniquement être éteint en coupant l'alimentation électrique.





- > Appuyez sur la touche  de la télécommande ou sur le bouton  du panneau de commande pour mettre le climatiseur de toit en marche ou en veille.



### 9.4.3 Sélection du mode de climatisation

- > Sélectionnez le mode de climatisation souhaité à l'aide de la touche MODE (Modes de climatisation (unique-ment pour les modèles FJX4233EEH/FJX4333E(EH)/FJX7333IHP/FJX7337IHP/FJX7457IHP) à la page 66).
- ✓ Le climatiseur de toit confirme la réception des valeurs par un signal sonore. Le climatiseur de toit passe sur mode de climatisation sélectionné.

### 9.4.4 Sélection manuelle de la vitesse du ventilateur

Dans tous les modes, à l'exception des modes Automatique ( **A** ) et Déshumidification (  ), la vitesse du ventilateur peut être sélectionnée manuellement.

Affichage à l'écran	Description
	Niveau de ventilation faible
	Niveau de ventilation intermédiaire
	Niveau de ventilation élevé.
	Niveau de ventilation Turbo.
	Mode Automatique (la vitesse du ventilateur est réglée en fonction de la température ambiante).

- > Appuyez sur la touche  de la télécommande ou sur le bouton  du panneau de commande pour sélectionner la vitesse de ventilation souhaitée.
- ✓ Le climatiseur de toit confirme la réception des valeurs par un signal sonore.

La nouvelle vitesse de ventilation est réglée.

### 9.4.5 Réglage de la température

En mode Automatique ( **A** ), Refroidissement (  ), Chauffage (  ) ou Déshumidification (  ), vous pouvez spécifier une température comprise entre 16 °C et 31 °C.

- > Utilisez la touche + ou – de la télécommande pour régler la température souhaitée.
- ✓ Le climatiseur de toit confirme la réception des valeurs par un son aigu. La température est réglée dans le climatiseur de toit.

### 9.4.6 Réglage de l'heure actuelle

La télécommande a besoin de l'heure actuelle pour la programmation de la minuterie. L'heure s'affiche sur l'écran de la télécommande.

1. Appuyez sur la touche  et maintenez-la enfoncée pour passer en mode Réglage de l'heure.
  - ✓ L'heure clignote sur l'écran de la télécommande.
2. Appuyez sur la touche + ou - pour régler l'heure actuelle. Appuyer sur la touche + ou – et maintenez-la enfoncée pendant plus de 2 s pour augmenter ou diminuer la valeur plus rapidement.
3. Appuyez sur la touche SET pour confirmer l'heure.

### 9.4.7 Réglage de la minuterie

La fonction de minuterie vous permet de régler la climatisation pour une période donnée. Vous pouvez spécifier l'heure de mise sous tension, l'heure de mise en veille ou les deux valeurs.

La fonction Minuterie est réglée à l'aide de la télécommande.



**Remarque** Lors de la programmation de la minuterie, si vous n'appuyez sur aucune touche pendant 15 s, la télécommande revient automatiquement au mode initial.

- > Réglez **la minuterie de mise en marche** comme suit :
  - a) Sélectionnez le mode de climatisation souhaité et toutes les valeurs requises (par exemple, la température).
  - b) Si nécessaire, mettez le climatiseur de toit en veille.
 

La minuterie de mise en marche peut uniquement être réglée lorsque le climatiseur de toit est **en veille**.
  - c) Appuyez une nouvelle fois sur le bouton .
  - ✓ Le symbole clignote sur l'écran de la télécommande.
  - d) À l'aide de la touche + ou -, réglez l'heure à laquelle le climatiseur de toit doit se mettre en marche.
  - e) Appuyez sur la touche .

La minuterie de mise en marche est réglée. Le climatiseur de toit s'allume avec le mode de climatisation sélectionné à l'heure spécifiée.
- > Réglez **la minuterie de mise en veille** comme suit :
  - a) Si nécessaire, mettez le climatiseur de toit en marche.
 

La minuterie de mise en veille peut uniquement être réglée lorsque le climatiseur de toit est **en marche**.
  - b) Appuyez deux fois sur la touche .
  - ✓ Le symbole clignote sur l'écran de la télécommande.
  - c) À l'aide de la touche + ou -, réglez l'heure à laquelle le climatiseur de toit doit passer en mode Veille.
  - d) Appuyez sur la touche .







La minuterie de mise en veille est réglée. Le climatiseur de toit passe en mode Veille à l'heure spécifiée.
- > Réglez **la minuterie de mise en marche et la minuterie de mise en veille** comme suit :
  - a) Sélectionnez le mode de climatisation souhaité et toutes les valeurs requises (par exemple, la température).
  - b) Appuyez trois fois sur la touche .
  - ✓ Le symbole s'affiche sur l'écran de la télécommande. Le symbole ON clignote.
  - c) À l'aide de la touche + ou -, réglez l'heure à laquelle le climatiseur de toit doit se mettre en marche.
  - d) Appuyez sur la touche .
  - ✓ Le symbole **OFF** clignote.
  - e) À l'aide de la touche + ou -, réglez l'heure à laquelle le climatiseur de toit doit passer en mode Veille.
  - f) Appuyez sur la touche .
  - ✓ Les heures de mise en marche et de mise en veille sont définies. Le climatiseur de toit s'allume pendant la période spécifiée.
  - > Pour **Annuler** la minuterie prédéfinie, appuyez une fois sur le bouton .
  - ✓ Les symboles disparaissent. Les valeurs prédéfinies sont ignorées.

### 9.4.8 Réglage de la fonction Sommeil

La fonction Sommeil est uniquement disponible en mode Refroidissement () ou Chauffage ().

La fonction Sommeil limite la vitesse du ventilateur afin de réduire le niveau sonore pour faciliter votre sommeil.

**Uniquement pour les modèles FJX7333IHP/FJX7337IHP/FJX7457IHP :** La fonction Sommeil limite également la vitesse du compresseur.

- > Pour activer la fonction Sommeil, procédez comme suit :
  - a) Réglez la température souhaitée (Réglage de la température à la page 70).
  - b) Appuyez sur la touche  de la télécommande ou sur le bouton  du panneau de commande.
- ✓ Le symbole  s'affiche sur l'écran de la télécommande. La fonction sommeil est activée.
  - > Pour désactiver la fonction Sommeil, appuyez sur la touche  ou  de la télécommande ou sur le bouton  du panneau de commande.
- ✓ Le symbole  disparaît de l'écran de la télécommande. La fonction Sommeil est désactivée.

### 9.4.9 Activation de la fonction Détection

Lorsque cette fonction est activée, la télécommande mesure la température ambiante et transmet la valeur mesurée au climatiseur de toit toutes les 10 minutes. Le climatiseur de toit adapte la valeur cible à cette mesure. La fonction Détection est uniquement active si la plage de températures est comprise entre +18 °C et +29 °C.

La télécommande ne doit pas se trouver dans un endroit de la pièce nettement plus chaud ou nettement plus froid que la température ambiante moyenne. Elle ne doit pas, par exemple, rester au soleil ou devant le climatiseur de toit.

Lorsque la température dépasse 29 °C ou passe en dessous de 18 °C, la fonction Détection est désactivée. Le symbole  clignote trois fois à l'écran, puis disparaît.

1. Appuyez sur le bouton.
- ✓ La fonction Détection est activée.

Le symbole  s'affiche à l'écran.

2. Orientez la télécommande vers le récepteur IR du panneau de commande. Sinon, les valeurs ne peuvent pas être transmises au climatiseur de toit.



### 9.4.10 Utilisation de l'éclairage ambiant







**AVERTISSEMENT ! Risque de blessure** Conformément à la loi, il est interdit d'utiliser l'éclairage intérieur lors de la conduite du véhicule.

La touche  de la télécommande est active même si la télécommande est éteinte.

**Uniquement pour les modèles FreshJet FJX4233EEH/FJX4333E(EH)/FJX7333IHP/FJX7337IHP/FJX7457IHP :**

- > Pour allumer ou éteindre l'éclairage intérieur, appuyez sur le bouton  de la télécommande ou du panneau de commande.
- ✓ Le symbole  clignote une fois sur l'écran de la télécommande lorsque l'éclairage intérieur est **allumé**.



- > Pour réduire l'intensité de l'éclairage intérieur, procédez comme suit :
  - a) Appuyez sur le bouton  de la télécommande ou du panneau de commande pendant 3 s.
  - b) Lorsque vous appuyez sur le bouton  de la télécommande : Appuyez sur le bouton  pour réduire la luminosité de l'éclairage intérieur entre 50 % et 100 %.
  - c) Lorsque vous appuyez sur le bouton  du panneau de commande : La luminosité de l'éclairage intérieur varie entre 50 % et 100 %. Relâchez le bouton  lorsque la luminosité souhaitée est atteinte.

#### Modèles FreshJet FJX7333IHP/FJX7337IHP/FJX7457IHP uniquement :

- > Pour allumer ou éteindre l'éclairage extérieur, appuyez sur le bouton  du panneau de commande.

### 9.4.11 Remplacement des piles de la télécommande



**Remarque** Il se peut que l'écran de la télécommande soit toujours allumé, même si les piles sont faibles. Remplacez les piles lorsque la télécommande indique que les piles sont faibles.

- > Remplacez les piles comme illustré.

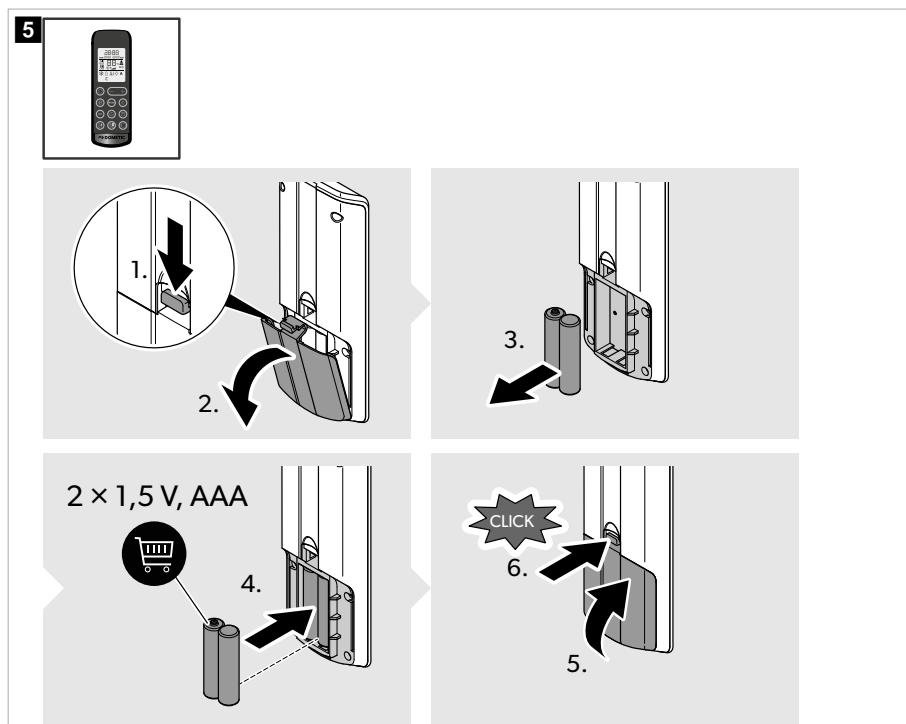

- ✓ L'écran affiche tous les symboles pendant 5 s.



Protégez l'environnement ! Les piles et les batteries usagées ne sont pas des déchets ménagers. Rap-  
portez les piles défectueuses ou les batteries usagées à votre revendeur ou à un centre de collecte.

## 9.5 Régulation de l'admission d'air dans le véhicule

Le débit d'air peut être réglé en direction du plafond ou vers le sol.

- > Tournez les lamelles des buses de ventilation indépendamment dans les directions requises.

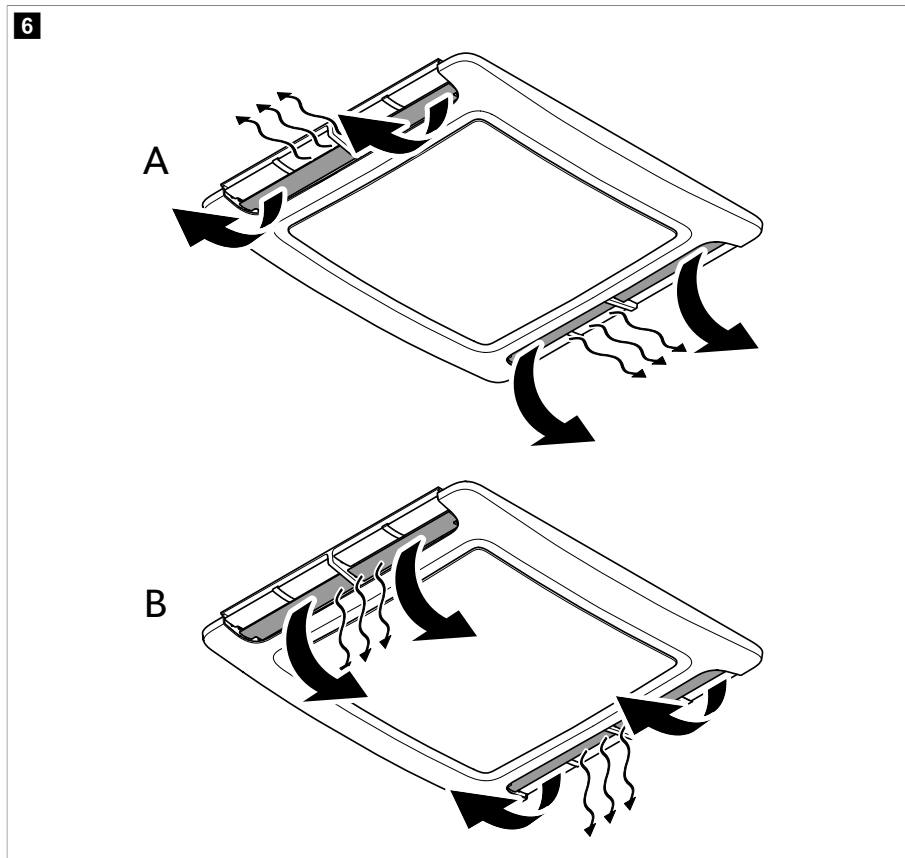

## 10 Nettoyage du climatiseur de toit



### AVIS ! Risque d'endommagement

- N'utilisez pour accélérer le processus de dégivrage ou pour le nettoyage aucun autre moyen que ceux recommandés par le fabricant.
- Ne nettoyez pas le climatiseur de toit avec un nettoyeur à haute pression. Toute infiltration d'eau peut endommager le climatiseur.
- N'utilisez pas d'objets tranchants ou durs, ni de détergents agressifs pour le nettoyage. Cela pourrait endommager le climatiseur de toit.
- N'utilisez en aucun cas de l'essence, du gasoil ou des solvants.

1. Retirez régulièrement les feuilles et autres saletés des grilles d'aspiration et de ventilation du climatiseur de toit. Veillez à ne pas endommager les grilles de ventilation lors de l'opération.

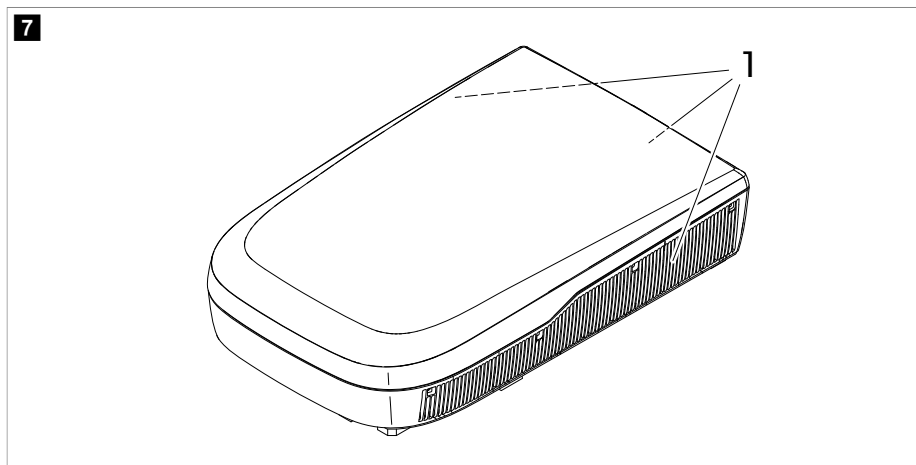

2. De temps à autre, nettoyez les carters de l'unité de toit et du caisson de distribution d'air avec un chiffon humide. Utilisez uniquement de l'eau avec un détergent doux.
3. **Uniquement pour les modèles FreshJet FJX4233EEH/FJX4333E(EH)/FJX7333IHP/FJX7337IHP/FJX7457IHP** : De temps à autre, nettoyez la télécommande avec un chiffon légèrement humide. Nettoyez l'écran à l'aide d'un chiffon pour lunettes.
4. **Uniquement pour les modèles FreshJet FJX4233EEH/FJX4333E(EH)/FJX7333IHP/FJX7337IHP/FJX7457IHP** De temps à autre, nettoyez l'écran du caisson de distribution d'air avec une solution douce d'eau chaude savonneuse. L'écran est en acrylique et peut être endommagé par certains produits chimiques courants tels que les détergents chimiques, les nettoyeurs pour vitres, l'alcool, certains agents de surface, les solvants organiques et adoucissants.

## 11 Maintenance

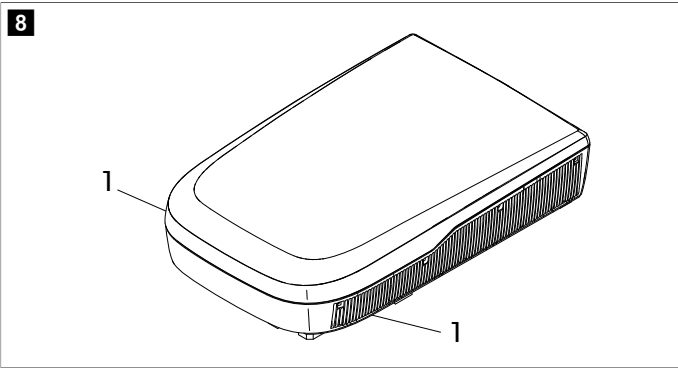
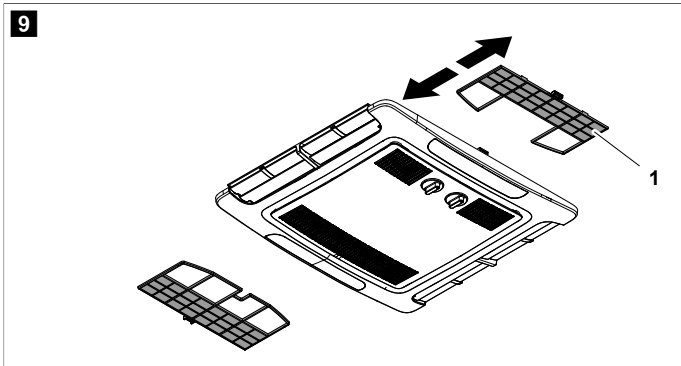

**AVERTISSEMENT ! Risque de blessure** Toute opération de maintenance autre que celles décrites dans ce document doit uniquement être réalisée par du personnel qualifié et connaissant les dangers liés à la manipulation de fluides frigorigènes, de climatiseurs, ainsi les réglementations applicables.

Intervalle	Inspection/maintenance
Régulièrement	<p data-bbox="333 188 1014 231">Vérifiez que les conduites d'écoulement de la condensation (1) latérales du climatiseur de toit sont dégagées et que l'eau de condensation peut s'écouler normalement.</p> <div data-bbox="333 247 1014 616"> <p data-bbox="344 256 367 284"><b>8</b></p>  </div>
Régulièrement (Freshjet FJX4233M)	<p data-bbox="333 643 665 663">Nettoyez le filtre de l'unité d'évacuation d'air.</p> <div data-bbox="333 679 1014 1046"> <p data-bbox="344 689 367 716"><b>9</b></p>  </div> <ol data-bbox="348 1062 874 1126" style="list-style-type: none"> <li>1. Retirez le filtre (1).</li> <li>2. Nettoyez le filtre (1) avec une solution détergente et laissez-le sécher.</li> <li>3. Réinstallez le filtre sec (1).</li> </ol>

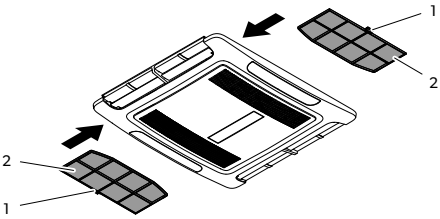
Intervalle	Inspection/maintenance
Régulièrement (modèles FreshJet FJX4233EEH/FJX4333E(EH)/FJX7333IHP/FJX7337IHP/FJX7457IHP)	<ul style="list-style-type: none"> <li>Nettoyez le filtre de l'unité d'évacuation d'air.</li> </ul> <div data-bbox="367 225 1016 528" style="border: 1px solid black; padding: 10px;"> <p><b>10</b></p>  </div> <ol style="list-style-type: none"> <li>Insérez un tournevis plat ou un couteau dans la poignée (1) pour faire sortir légèrement les filtres (2).</li> <li>Retirez les filtres à la main.</li> <li>Nettoyez les filtres avec une solution détergente et laissez-les sécher.</li> <li>Remettez les filtres secs en place en les faisant glisser. fig. 10 à la page 77</li> </ol> <ul style="list-style-type: none"> <li>Faites réviser l'échangeur thermique du climatiseur de toit par une société spécialisée.</li> </ul>
Une fois par an	<ul style="list-style-type: none"> <li>Vérifiez que les joints entre le climatiseur et le toit du véhicule ne présentent pas de fissures ou d'autres dégâts.</li> <li>Assurez-vous que les vis de fixation sont serrées au couple prévu (2.5 Nm ± 0.3 Nm) et réajustez-les si nécessaire.</li> </ul>

## 12 Dépannage

Panne	Cause possible	Solution proposée
Refroidissement insatisfaisant	Le climatiseur de toit n'est pas réglé en mode refroidissement.	Mettez le climatiseur de toit en mode refroidissement.
	La température ambiante est supérieure à 52 °C.	Le climatiseur de toit est conçu pour une température ambiante inférieure ou égale à 52 °C.
	La température réglée est supérieure à la température ambiante.	Sélectionnez une température plus basse.
	La température ambiante est inférieure à 16 °C.	Le climatiseur de toit est conçu pour refroidir uniquement lorsque la température ambiante est supérieure à 16 °C.
	L'un des capteurs de température est défectueux.	Contactez un agent de service agréé ou Dometic.
	Le ventilateur de l'évaporateur est défectueux.	Contactez un agent de service agréé ou Dometic.

Panne	Cause possible	Solution proposée
	Le ventilateur du condensateur est défectueux.	Contactez un agent de service agréé ou Dometic.
<b>Uniquement pour les modèles FreshJet FJX4233EEH/FJX4333E(E-H)/FJX7333IHP/FJX7337IHP/FJX7457IHP</b> : Chauffage insatisfaisant	Le climatiseur de toit n'est pas réglé en mode chauffage.	Mettez le climatiseur de toit en mode chauffage.
	La température ambiante est inférieure à $-2^{\circ}\text{C}$ .	Le climatiseur de toit est conçu pour fonctionner lorsque la température ambiante est supérieure à $-2^{\circ}\text{C}$ .
	La température réglée est inférieure à la température ambiante.	Sélectionnez une température plus élevée.
	L'un des capteurs de température est défectueux.	Contactez un agent de service agréé ou Dometic.
	Le ventilateur de l'évaporateur est défectueux.	Contactez un agent de service agréé ou Dometic.
Débit d'air faible	Les orifices d'aspiration sont bloqués ou obstrués.	Retirez les feuilles et autres saletés qui encombreront les grilles d'aération du climatiseur de toit.
	Le ventilateur est défectueux.	Contactez un agent de service agréé ou Dometic.
Infiltration d'eau dans le véhicule.	Les ouvertures d'écoulement d'eau de condensation sont bouchées.	Nettoyez les orifices d'évacuation de l'eau de condensation.
	Les joints sont défectueux.	Contactez un agent de service agréé ou Dometic.
Le climatiseur de toit ne se met pas en marche.	Aucune alimentation électrique connectée.	Vérifiez l'alimentation électrique.
	La tension est trop faible ( $< 200\text{ V}$ ).	Contactez un agent de service agréé ou Dometic.
	Le transformateur de tension est défectueux.	Contactez un agent de service agréé ou Dometic.
	L'un des capteurs de température est défectueux.	Contactez un agent de service agréé ou Dometic.
	Le fusible électrique de l'alimentation électrique est trop faible.	Contactez un agent de service agréé ou Dometic.
Le climatiseur de toit ne s'éteint pas.	L'un des capteurs de température est défectueux.	Contactez un agent de service agréé ou Dometic.
	Le fusible électrique de l'alimentation électrique est trop faible.	Contactez un agent de service agréé ou Dometic.

Panne	Cause possible	Solution proposée
<b>Uniquement pour les modèles Freshjet FJX4233EEH/FJX4333E(E-H)/FJX7333IHP/FJX7337IHP/FJX7457IHP</b> : Le climatiseur de toit s'éteint en permanence.	Le capteur de gel s'est déclenché.	La température extérieure est trop basse ou toutes les buses de ventilation sont fermées.
L'écran affiche : P0	Surchauffe ou surintensité du module IPM	Contactez un agent de service agréé ou Dometic.
L'écran affiche : P1	Protection contre la sous-tension	Contactez un agent de service agréé ou Dometic.
L'écran affiche : P2	Protection contre la surintensité CA de l'unité	Contactez un agent de service agréé ou Dometic.
L'écran affiche : P4	Protection contre la surchauffe du tube de décharge	Contactez un agent de service agréé ou Dometic.
L'écran affiche : P5	Protection de la bobine de l'évaporateur (mode Refroidissement)	Contactez un agent de service agréé ou Dometic.
L'écran affiche : P6	Protection de la bobine du condenseur (mode Refroidissement)	Contactez un agent de service agréé ou Dometic.
L'écran affiche : P7	Protection de la bobine de l'évaporateur (mode Chauffage)	Contactez un agent de service agréé ou Dometic.
L'écran affiche : P9	Le compresseur ne fonctionne pas correctement ou ne démarre pas	Contactez un agent de service agréé ou Dometic.
L'écran affiche : E0	Échec de communication	Contactez un agent de service agréé ou Dometic.
L'écran affiche : E1	Défaut du capteur de température ambiante	Contactez un agent de service agréé ou Dometic.
L'écran affiche : E2	Défaut du capteur de température de la bobine de l'évaporateur	Contactez un agent de service agréé ou Dometic.
L'écran affiche : E3	Défaut du capteur de température de la bobine du condenseur	Contactez un agent de service agréé ou Dometic.
L'écran affiche : E7	Défaillance du capteur de température extérieur	Contactez un agent de service agréé ou Dometic.
L'écran affiche : E8	Défaillance du capteur de température du tube de décharge	Contactez un agent de service agréé ou Dometic.
L'écran affiche : E9	Défaut de fonctionnement du compresseur ou du module IPM	Contactez un agent de service agréé ou Dometic.
L'écran affiche : EA	Défaut du capteur de courant	Contactez un agent de service agréé ou Dometic.
L'écran affiche : EE	Défaut EEPROM extérieur	Contactez un agent de service agréé ou Dometic.

Panne	Cause possible	Solution proposée
L'écran affiche : EL	Échec de communication du BUS LIN/CI	Contactez un agent de service agréé ou Dometic.

## 13 Mise au rebut



Dans la mesure du possible, veuillez éliminer les emballages dans les conteneurs de déchets recyclables prévus à cet effet. Pour éliminer définitivement le produit, contactez le centre de recyclage le plus proche ou votre revendeur spécialisé afin de vous informer sur les dispositions relatives au retraitement des déchets.



Protégez l'environnement ! Les piles et les batteries usagées ne sont pas des déchets ménagers. Rapportez les piles défectueuses ou les batteries usagées à votre revendeur ou à un centre de collecte.

## 14 Garantie

La période de garantie légale s'applique. Si le produit s'avérait défectueux, contactez la succursale du fabricant située dans votre pays (voir [dometic.com/dealer](http://dometic.com/dealer)) ou votre revendeur.

Pour toutes réparations ou autres prestations de garantie, veuillez joindre à l'appareil les documents suivants :

- une copie de la facture avec la date d'achat
- un motif de réclamation ou une description du dysfonctionnement

Notez que toute réparation effectuée par une personne non agréée peut présenter un risque de sécurité et annuler la garantie.

## 15 Caractéristiques techniques

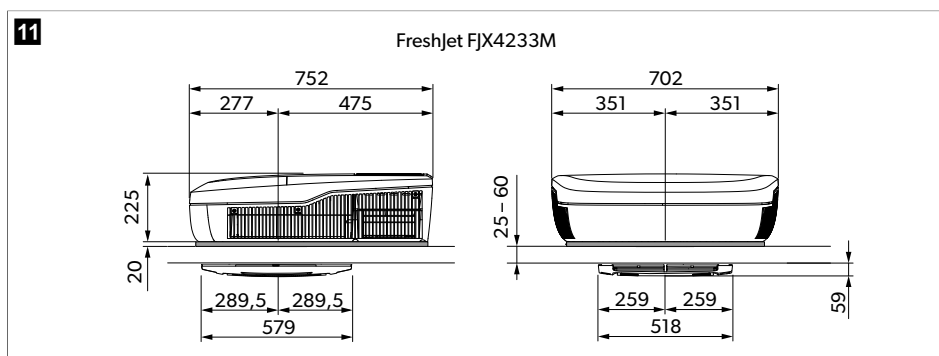



12

FJX4233EEH, FJX4333E(EH), FJX7333IHP

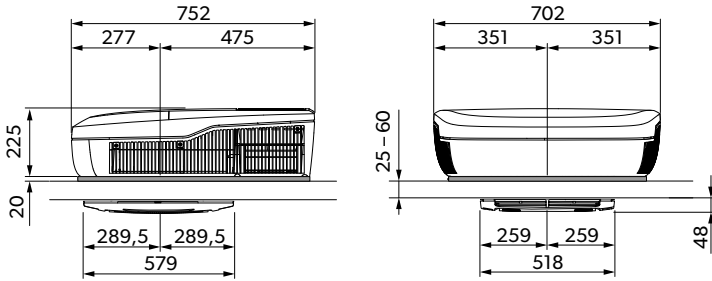

13

FreshJet FJX7337IHP

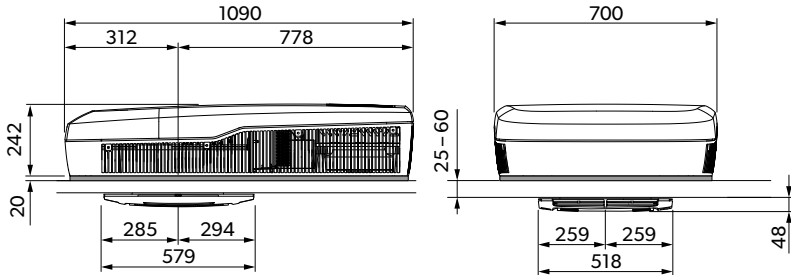

14

FreshJet FJX7457IHP

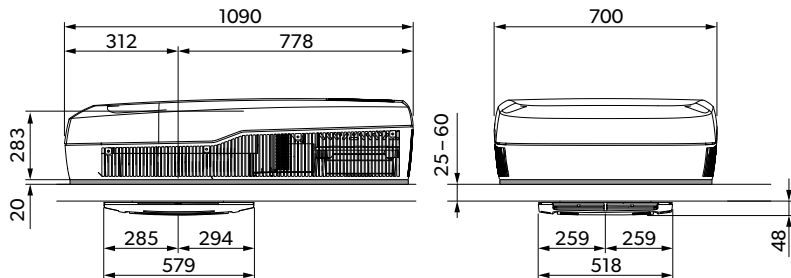

Contient des gaz à effet de serre fluorés. Équipement hermétique.

<b>FreshJet FJX4233M</b>	
Puissance frigorifique selon ISO 5151 :	1500 W
Tension d'entrée CA :	220 V ... 240 V / 50 Hz

	<b>FreshJet FJX4233M</b>
Courant nominal refroidissement :	< 3.3 A
Fusible requis :	4 A
Plage de température de fonctionnement :	- 2 °C ... 52 °C
Fluide frigorigène :	R410a
Quantité de fluide frigorigène :	380 g
Équivalent CO <sub>2</sub> :	0.793 t
Potentiel d'effet de serre (GWP) :	2088
Classe de protection (unité de toit) :	IPX4
Niveau de bruit (réglage de ventilateur le plus élevé)	< 70 dB(A)
Longueur max. recommandée du véhicule (avec parois isolées) :	< 5 m
Dimensions L x l x H :	fig. 11 à la page 80
Poids :	< 30 kg
Contrôle/certification :	

	<b>FreshJet FJX4233EEH</b>	<b>FreshJet FJX4333EEH</b>	<b>FreshJet FJX4333E</b>
Puissance frigorifique selon ISO 5151 :	1700 W	2200 W	2200 W
Puissance calorifique selon la norme ISO 5151 :	800 W	1000 W	-
Tension d'entrée CA :	220 V ... 240 V / 50 Hz		
Courant nominal refroidissement :	3.6 A	4.8 A	4.8 A
Courant nominal chauffage :	< 5.2 A	< 5.2 A	-
Fusible requis :	4 A	5 A	6 A

	<b>FreshJet FJX4233EEH</b>	<b>FreshJet FJX4333EEH</b>	<b>FreshJet FJX4333E</b>
Plage de température de fonctionnement :	- 2 °C ... 52 °C		
Fluide frigorigène :	R32		
Quantité de fluide frigorigène :	320 g	360 g	360 g
Équivalent CO <sub>2</sub> :	0.216 t	0.243 t	0.243 t
Potentiel d'effet de serre (GWP) :	675		
Classe de protection (unité de toit) :	IPX4		
Niveau de bruit (réglage de ventilateur le plus élevé)	< 70 dB(A)		
Longueur max. recommandée du véhicule (avec parois isolées) :	< 6 m	< 7 m	< 7 m
Dimensions L x l x H :	fig. 12 à la page 81		
Poids :	< 30 kg	< 30 kg	< 30 kg
Contrôle/certification :			

	<b>FreshJet FJX7333IHP</b>	<b>FreshJet FJX7337IHP</b>	<b>FreshJet FJX7457IHP</b>
Puissance frigorifique selon ISO 5151 :	2200 W	3000 W	3500 W
Puissance calorifique selon la norme ISO 5151 :	2000 W	2500 W	3000 W
Tension d'entrée CA :	220 V ... 240 V / 50 Hz ... 60 Hz	220 V ... 240 V / 50 Hz ... 60 Hz	220 V ... 240 V / 50 Hz ... 60 Hz
Courant nominal refroidissement :	< 7.5 A	< 7.5 A	< 7.5 A
Courant nominal chauffage :	< 6.1 A	< 6.1 A	< 6.1 A
Fusible requis :	6 A	6 A	6 A
Plage de température de fonctionnement :	- 2 °C ... 52 °C	- 2 °C ... 52 °C	- 2 °C ... 52 °C
Fluide frigorigène :	R32	R32	R32

	<b>FreshJet FJX7333IHP</b>	<b>FreshJet FJX7337IHP</b>	<b>FreshJet FJX7457IHP</b>
Quantité de fluide frigorigène :	420 g	480 g	650 g
Équivalent CO <sub>2</sub> :	0.2835 t	0.3240 t	0.43875 t
Potentiel d'effet de serre (GWP) :	675		
Classe de protection (unité de toit) :	IPX4		
Niveau de bruit (réglage de ventilateur le plus élevé)	< 70 dB(A)		
Longueur max. recommandée du véhicule (avec parois isolées) :	< 7 m	< 7 m	> 8 m
Dimensions L x l x H :	fig. <b>12</b> à la page 81	fig. <b>13</b> à la page 81	fig. <b>14</b> à la page 81
Poids :	< 30 kg	< 35 kg	< 40 kg
Contrôle/certification :			

## Spanish

1	Important notes.....	85
2	Explicación de los símbolos.....	85
3	Indicaciones de seguridad.....	86
4	Uso previsto.....	87
5	Explicación de los símbolos del aparato.....	88
6	Límites y condiciones técnicas.....	88
7	Descripción técnica.....	88
8	Antes del primer uso.....	94
9	Funcionamiento.....	95
10	Limpieza del equipo de aire acondicionado de techo.....	103
11	Mantenimiento.....	103
12	Solución de problemas.....	105
13	Gestión de residuos.....	108
14	Garantía.....	108
15	Datos técnicos.....	109

## 1 Important notes

Lea atentamente estas instrucciones y siga las indicaciones, directrices y advertencias incluidas en este manual para asegurarse de que instala, utiliza y mantiene correctamente el producto en todo momento. Estas instrucciones DEBEN conservarse junto con este producto.

Al utilizar el producto, usted confirma que ha leído cuidadosamente todas las instrucciones, directrices y advertencias, y que entiende y acepta cumplir los términos y condiciones aquí establecidos. Usted se compromete a utilizar este producto solo para el propósito y la aplicación previstos y de acuerdo con las instrucciones, directrices y advertencias establecidas en este manual del producto, así como de acuerdo con todas las leyes y reglamentos aplicables. La no lectura y observación de las instrucciones y advertencias aquí expuestas puede causarle lesiones a usted o a terceros, daños en el producto o daños en otras propiedades cercanas. Este manual del producto, incluyendo las instrucciones, directrices y advertencias, y la documentación relacionada, pueden estar sujetos a cambios y actualizaciones. Para obtener información actualizada sobre el producto, visite la página [documents.dometic.com](http://documents.dometic.com).

## 2 Explicación de los símbolos



**¡PELIGRO!** Indica una situación peligrosa que, de no evitarse, ocasionará la muerte o lesiones graves.



**¡ADVERTENCIA!** Indica una situación peligrosa que, de no evitarse, ocasionará la muerte o lesiones graves.



**¡ATENCIÓN!** Indica una situación peligrosa que, de no evitarse, puede ocasionar lesiones moderadas o leves.



**¡AVISO!** Indica una situación peligrosa que, de no evitarse, puede ocasionar o lesiones moderadas o leves.



**Nota** Información complementaria para el manejo del producto.

### 3 Indicaciones de seguridad



**¡ADVERTENCIA! El incumplimiento de estas advertencias podría acarrear la muerte o lesiones graves.**

- **Los aparatos eléctricos no son juguetes.** El aparato no debe ser utilizado por personas (incluyendo niños) con capacidades físicas, sensoriales o mentales reducidas, o con falta de experiencia y conocimientos, a menos que estén bajo supervisión o se les haya instruido al respecto.
- Se debe vigilar que los niños no jueguen con el aparato.
- Este aparato puede ser utilizado por menores a partir de 8 años y por personas con capacidades físicas, sensoriales o mentales reducidas, o bien con falta de experiencia y conocimientos, siempre que lo hagan bajo supervisión o hayan recibido instrucciones relativas a un empleo seguro del mismo de y consciente de los riesgos asociados.
- La limpieza no debe ser realizada por menores sin supervisión.
- Cualquier persona que manipule o abra un circuito de refrigeración deberá tener una certificación vigente expedida por una autoridad evaluadora con competencia en el sector y que demuestre la competencia de dicha persona para manipular refrigerantes de forma segura de acuerdo con las especificaciones de evaluación reconocidas en el sector.
- Los trabajos de mantenimiento deberán realizarse siguiendo solamente las recomendaciones del fabricante del equipo. Los trabajos de mantenimiento y reparación que requieran la asistencia de más personal cualificado se llevarán a cabo bajo la supervisión de la persona competente en el uso de refrigerantes inflamables.
- La reparación del aparato solo podrá ser llevada a cabo por personal especializado y familiarizado con los riesgos y normas pertinentes. Las reparaciones realizadas incorrectamente pueden generar situaciones de considerable peligro. En caso de necesitar una reparación, póngase en contacto con el centro de atención al cliente de su país (véase [dometic.com/dealer](http://dometic.com/dealer)).
- Desconecte el aparato de la fuente de alimentación siempre que realice trabajos en él.
- El aparato debe guardarse en un espacio donde no haya focos de ignición en continuo funcionamiento, como un fuego abierto, aparatos de gas o un horno eléctrico encendido.
- No perforo ni queme el aparato.
- Tenga en cuenta que los refrigerantes pueden no tener olor.
- No utilice el aparato cerca de fluidos inflamables ni en recintos cerrados.
- Asegúrese que no haya objetos inflamables situados o instalados cerca de la salida de aire. Debe mantenerse una distancia mínima de 50 cm.
- No deje que las aberturas de ventilación queden obstruidas.
- No dañe el circuito de frío.
- En ningún caso utilice fuentes de ignición potenciales para buscar o detectar fugas de refrigerante. No utilice lámparas de haluro (o cualquier otro detector con llama desnuda).
- El equipo de aire acondicionado de techo debe instalarse en un vehículo con una superficie de suelo superior a 4 m<sup>2</sup>.



**¡ATENCIÓN! El incumplimiento de estas precauciones podría acarrear lesiones moderadas o leves.**

- No acceda a las salidas de aire ni introduzca objetos extraños en el equipo.
- En caso de incendio, no abra la tapa superior del aparato. Utilice agentes autorizados para la extinción del fuego. No utilice agua para extinguir el fuego.
- Si el cable de alimentación está dañado, deberá ser sustituido por el fabricante, un técnico de mantenimiento autorizado o por personal cualificado para evitar posibles peligros.
- Si el aparato contiene un ionizador, consulte a su médico si ello puede ser perjudicial para su salud. El ionizador puede producir ozono (O<sub>3</sub>) en pequeñas cantidades. Si sufre de alguna enfermedad pulmonar, asma, cardiopatía, enfermedad respiratoria, problemas respiratorios o es sensible al ozono, consulte a su médico para determinar si el uso de este dispositivo es bueno para su salud.



**¡AVISO! Peligro de daños**

- Para acelerar el proceso de descongelación o limpiar el aparato, utilice solamente los procedimientos recomendados por el fabricante.
- El aparato debe situarse de tal manera que se eviten posibles daños mecánicos.
- No realice modificaciones en el aparato.
- No introduzca su vehículo en túneles de lavado automático si el equipo está instalado.
- Si el circuito de refrigeración está dañado, el aparato deberá ser revisado y reparado por el fabricante, un técnico de mantenimiento autorizado o por personal igualmente cualificado para evitar posibles peligros.

## 4 Uso previsto

El equipo de aire acondicionado de techo FreshJet FJX está diseñado exclusivamente para ser instalado en el techo de una caravana o autocaravana con el objetivo de proporcionar refrigeración.

El equipo de aire acondicionado de techo **no** es adecuado para trenes, casas o apartamentos. El equipo de aire acondicionado de techo **no** es adecuado para ser instalado en máquinas de construcción, máquinas agrícolas o equipos similares.

Este producto solo es apto para el uso previsto y la aplicación de acuerdo con estas instrucciones.

Este manual proporciona la información necesaria para la correcta instalación y/o funcionamiento del producto. Una instalación deficiente y/o un uso y mantenimiento inadecuados conllevan un rendimiento insatisfactorio y posibles fallos.

El fabricante no se hace responsable de ninguna lesión o daño en el producto ocasionados por:

- Un montaje o conexión incorrectos, incluido un exceso de tensión
- Un mantenimiento incorrecto o el uso de piezas de repuesto distintas de las originales proporcionadas por el fabricante
- Modificaciones realizadas en el producto sin el expreso consentimiento del fabricante
- Uso con una finalidad distinta de la descrita en las instrucciones

Dometic se reserva el derecho de cambiar la apariencia y las especificaciones del producto.

## 5 Explicación de los símbolos del aparato



¡Advertencia! Material de baja velocidad de combustión.



Lea las instrucciones de uso.



Lea el manual de servicio.

## 6 Límites y condiciones técnicas

El equipo de aire acondicionado de techo está diseñado para vehículos con techos con un grosor de 25 mm ... 60 mm. El funcionamiento del equipo de aire acondicionado de techo está garantizado para temperaturas ambiente de entre  $-2^{\circ}\text{C}$  ...  $52^{\circ}\text{C}$ . El equipo de aire acondicionado de techo está diseñado para ser instalado a  $\pm 10^{\circ}$  del plano horizontal. El rendimiento del equipo de aire acondicionado de techo puede verse reducido cuando se expone a vibraciones fuertes, como las causadas por un mal estado de la carretera.

## 7 Descripción técnica

El equipo de aire acondicionado de techo FreshJet FjX4233M suministra aire frío sin polvo ni suciedad en el interior del vehículo y con posibilidad de deshumidificación.

El equipo de aire acondicionado de techo FreshJet FjX4233EEH/FjX4333E(EH)/FjX7333IHP/FjX7337IHP/FjX7457IHP suministra aire frío o caliente sin polvo ni suciedad al interior del vehículo y con posibilidad de deshumidificación.

El equipo de aire acondicionado de techo puede reducir la temperatura interior del vehículo hasta un nivel determinado que depende del tipo de vehículo, la temperatura ambiente y la capacidad de enfriamiento del equipo en cuestión. Por debajo de una temperatura exterior de  $16^{\circ}\text{C}$ , el equipo de aire acondicionado de techo deja de enfriar.

El equipo de aire acondicionado de techo se controla con los siguientes elementos mando:

- Panel de control

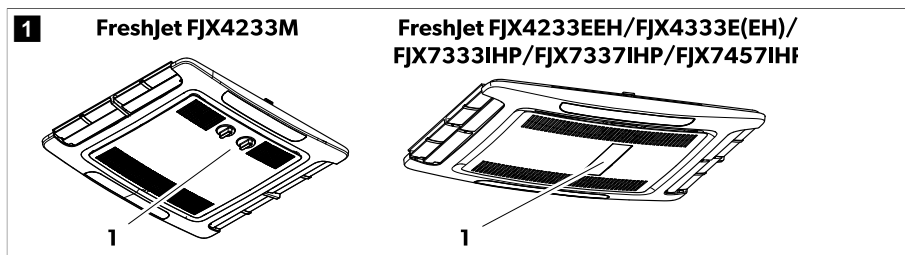



- Control remoto (solo FJX4233EEH/FJX4333E(EH)/FJX7333IHP/FJX7337IHP/FJX7457IHP)

## 7.1 Lista de modelos

La siguiente tabla muestra qué funciones tiene cada modelo:





● Función disponible

○ Función implementable

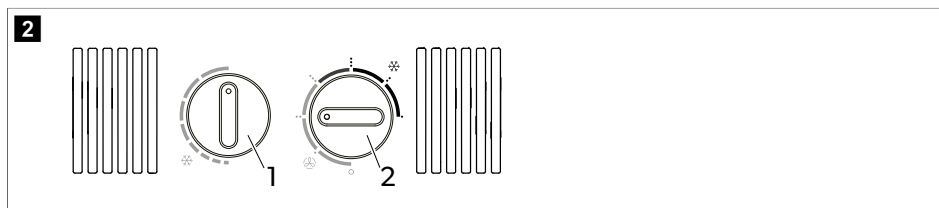
	FJX4233M	FJX4233EEH	FJX4333EEH	FJX4333E	FJX7333IHP	FJX7337IHP	FJX7457IHP
Automático		●	●	●	●	●	●
Refrigeración	●	●	●	●	●	●	●
Calentar		●	●	○	●	●	●
Ventilación	●	●	●	●	●	●	●
Deshumidificación		●	●	●	●	●	●
Purificador de aire	○	●	●	○	●	●	●
Luz ADB		●	●	○	●	●	●
Luz externa					●	●	●
Temporizador		●	●	●	●	●	●
Sleep		●	●	●	●	●	●
Arranque suave			●	○	●	●	●









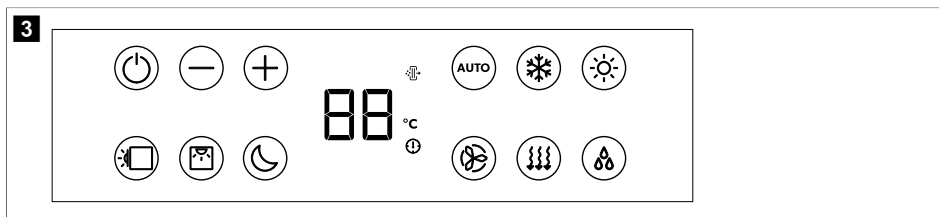



## 7.2 Panel de control de FreshJet FJX4233M







Regulador	Descripción
	Selecciona la temperatura. Gire en sentido horario para aumentar el frío.
	Enciende o apaga el equipo de aire acondicionado de techo y selecciona la intensidad de circulación del aire en el modo de ventilación (  ) o la intensidad de enfriamiento en el modo de refrigeración (  )

### 7.3 Panel de control FreshJet FJX4233EEH/FJX4333E(EH)/FJX7333IHP/FJX7337IHP/FJX7457IHP



















Símbolo	Descripción
	Enciende el equipo de aire acondicionado de techo o lo pone en modo preparado.
	Incrementa el valor visualizado actualmente.
	Disminuye el valor visualizado actualmente.
	Se empareja con bluetooth/WLAN al pulsar ambos botones simultáneamente.
	Enciende o apaga la iluminación ambiental de la unidad superior de techo.
	Enciende o apaga la iluminación ambiental de la caja de distribución de aire.
	Activa la función Sleep (Funciones adicionales (solo FJX4233EEH/FJX4333E(EH)/FJX7333IHP/FJX7337IHP/FJX7457IHP) en la página 94).
	Muestra la temperatura ajustada e indica el nivel del ventilador cuando se ajusta el ventilador.
	Indica que el modo de purificador de aire está activo.
	Indica que la temperatura se muestra en grados centígrados.
	Indica que el temporizador está programado.
	Habilita o deshabilita el modo automático (Modos de aire acondicionado (solo FJX4233EEH/FJX4333E(EH)/FJX7333IHP/FJX7337IHP/FJX7457IHP) en la página 93).

Símbolo	Descripción
	Habilita o deshabilita el modo de enfriamiento (Modos de aire acondicionado (solo FJX4233EEH/FJX4333E(EH)/FJX7333IHP/FJX7337IHP/FJX7457IHP) en la página 93).
	Habilita o deshabilita el modo de calentamiento (Modos de aire acondicionado (solo FJX4233EEH/FJX4333E(EH)/FJX7333IHP/FJX7337IHP/FJX7457IHP) en la página 93).
	Ajusta la velocidad del ventilador en baja, media, alta, turbo o automática (en la pantalla de la caja de distribución de aire se muestran los caracteres 1, 2, 3, 4 o AA respectivamente al cambiar la velocidad).
	Habilita o deshabilita el modo de ventilación (Modos de aire acondicionado (solo FJX4233EEH/FJX4333E(EH)/FJX7333IHP/FJX7337IHP/FJX7457IHP) en la página 93). Hace circular el aire sin calentarlo ni enfriarlo.
	Habilita o deshabilita el modo de deshumidificación (Modos de aire acondicionado (solo FJX4233EEH/FJX4333E(EH)/FJX7333IHP/FJX7337IHP/FJX7457IHP) en la página 93).

## 7.4 Control remoto FreshJet FJX4233EEH/FJX4333E(EH)/FJX7333IHP/FJX7337IHP/FJX7457IHP





Elementos de control y pantalla fig. **4** en la página 91:

Botón	Descripción
—	<p><b>Pantalla</b></p> <p>Se visualiza lo siguiente:</p> <ul style="list-style-type: none"> <li>• Hora</li> <li>• Temperatura ambiente seleccionada (valor de referencia) en °C</li> <li>• temperatura interior actual</li> <li>• Modo de aire acondicionado</li> <li>• Velocidad de ventilación</li> <li>• Símbolos de funciones adicionales activas</li> <li>• estado de la batería</li> </ul>
	Enciende el equipo de aire acondicionado de techo o lo pone en modo preparado.
	Incrementa el valor visualizado actualmente.
	Disminuye el valor visualizado actualmente.
	Selecciona la velocidad del ventilador (Selección manual de la velocidad del ventilador en la página 97).
	Selecciona el modo de aire acondicionado (Modos de aire acondicionado (solo FJX4233EEH/FJX4333E(EH)/FJX7333IHP/FJX7337IHP/FJX7457IHP) en la página 93). Se muestra el símbolo correspondiente.
	Activa la función Sleep (Funciones adicionales (solo FJX4233EEH/FJX4333E(EH)/FJX7333IHP/FJX7337IHP/FJX7457IHP) en la página 94). Aparece el símbolo  .
	Confirma y guarda los ajustes.
	Ajusta el temporizador y el reloj.
	Enciende o apaga la iluminación ambiental de la caja de distribución de aire.
	<p>Pulse una vez para ver la temperatura interior actual. Aparece el símbolo .</p> <p>Pulse dos veces para ver la temperatura ajustada.</p>
	<p>Activa la función I Feel. Aparece el símbolo .</p> <p>Cada 10 min, la función I Feel ajusta la temperatura de referencia a la temperatura real medida por el control remoto.</p>
	Enciende o apaga la iluminación ambiental de la unidad superior de techo.
	Indica que las pilas del mando a distancia están agotadas. Cambie las pilas (Sustitución de las pilas del control remoto en la página 100).
	Indica que el control remoto está transmitiendo datos al equipo de aire acondicionado de techo.





## 7.5 Modos del aire acondicionado (solo FJX4233M)

El equipo de aire acondicionado de techo tiene los siguientes modos de aire acondicionado:

Modo de aire acondicionado	Símbolo en pantalla	Descripción
Refrigeración		Usted especifica la temperatura y los ajustes del ventilador, y el equipo de aire acondicionado de techo enfría el interior hasta alcanzar la temperatura especificada.
Ventilación		Usted especifica los ajustes del ventilador y el equipo de aire acondicionado de techo hace circular el aire sin calentar ni enfriar.





## 7.6 Modos de aire acondicionado (solo FJX4233EEH/FJX4333E(EH)/FJX7333IHP/FJX7337IHP/FJX7457IHP)

El equipo de aire acondicionado de techo tiene los siguientes modos de aire acondicionado:

Modo de aire acondicionado	Símbolo en pantalla	Descripción
Automático	<b>A</b>	Usted especifica la temperatura y el equipo de aire acondicionado de techo genera dicha temperatura en el interior calentando o enfriando el aire y controlando la velocidad del ventilador adecuada.
Refrigeración		Usted especifica la temperatura y los ajustes del ventilador, y el equipo de aire acondicionado de techo enfría el interior hasta alcanzar la temperatura especificada.
Calentar		<b>No FJX4333E:</b> Usted especifica la temperatura y los ajustes del ventilador, y el equipo de aire acondicionado de techo calienta el interior hasta alcanzar la temperatura especificada. El ventilador tarda 2 min en ponerse en marcha (a velocidad baja) y después de aproximadamente 5 min pasa a la velocidad fijada (cuando el evaporador ha alcanzado la temperatura).
Ventilación		Usted especifica los ajustes del ventilador y el equipo de aire acondicionado de techo hace circular el aire sin calentar ni enfriar.
Deshumidificación del aire		El equipo de aire acondicionado de techo elimina la humedad del ambiente sin calentar o enfriar el interior, reduciendo así la humedad relativa del aire.
Purificador de aire		<b>No FJX4333E:</b> El equipo de aire acondicionado de techo ioniza el aire y recoge de esta manera el polvo y otras partículas, incluyendo virus y bacterias presentes en el ambiente.

## 7.7 Funciones adicionales (solo FJX4233EEH/FJX4333E(EH)/FJX7333IHP/FJX7337IHP/FJX7457IHP)

El equipo de aire acondicionado de techo dispone de las siguientes funciones adicionales:

Función adicional	Mensaje en pantalla	Descripción
Temporizador		El equipo de aire acondicionado de techo se enciende a la hora ajustada.
		El equipo de aire acondicionado de techo se apaga a la hora ajustada.
		El equipo de aire acondicionado de techo se enciende y se apaga a las horas ajustadas.
Sleep		La función Sleep reduce la velocidad del ventilador y del compresor para rebajar el nivel de ruido y facilitar el sueño.
I Feel		El control remoto mide la temperatura ambiente y transmite esta medición al equipo de aire acondicionado de techo cada 10 min. El equipo de aire acondicionado de techo adapta el valor de referencia a esta medición.
Arranque suave		<b>No FJX4233EEH:</b> El pico de corriente generado al ponerse en marcha del compresor queda reducido con la función de arranque suave. Si la fuente de alimentación es un generador, este no se sobrecargará.

## 8 Antes del primer uso

### Controles antes de la puesta en marcha

Antes de encender el equipo de aire acondicionado de techo tenga en cuenta lo siguiente:

1. Compruebe si la tensión de alimentación y la frecuencia coinciden con los valores especificados en Datos técnicos en la página 109.
2. Asegúrese de que las aberturas de entrada de aire y las boquillas de aire no estén obstruidas. Todas las rejillas de ventilación deben mantenerse siempre libres de obstáculos para garantizar que el equipo de aire acondicionado de techo pueda funcionar a su máxima potencia.

### Preparación del control remoto (solo FreshJet FJX4233EEH/FJX4333E(EH)/FJX7333IHP/FJX7337IHP/FJX7457IHP)

3. Introduzca las pilas (Sustitución de las pilas del control remoto en la página 100).

### Establezca la hora (solo FreshJet FJX4233EEH/FJX4333E(EH)/FJX7333IHP/FJX7337IHP/FJX7457IHP)

4. Establezca la hora actual (Ajuste de la hora actual en la página 98).

## 9 Funcionamiento

### 9.1 Consejos para un uso óptimo

Los siguientes consejos le ayudarán a optimizar el rendimiento de su equipo de aire acondicionado de techo:

- Mejore el aislamiento térmico del vehículo sellando rendijas e instalando persianas reflectantes o cortinas en las ventanas.
- Seleccione una temperatura y una velocidad de ventilación adecuadas.
- Oriente las boquillas de aire según convenga.
- Asegúrese de que las boquillas y las aberturas de entrada de aire no queden cubiertas con ropa, papel ni otros objetos.
- **Solo FreshJet FJX4233EEH/FJX4333E(EH)/FJX7333IHP/FJX7337IHP/FJX7457IHP:** Si el vehículo ha estado expuesto a la luz solar directa durante mucho tiempo: Ponga en marcha el equipo de aire acondicionado de techo en el modo de ventilación (☺☺☺) con las ventanas abiertas durante un tiempo antes de encender el modo de refrigeración (☼☼).
- **Solo FreshJet FJX4233EEH/FJX4333E(EH)/FJX7333IHP/FJX7337IHP/FJX7457IHP:** Evite en la medida de lo posible abrir puertas y ventanas cuando el equipo funciona con el modo de refrigeración (☼☼).

### 9.2 Indicaciones básicas para el manejo

El equipo de aire acondicionado de techo FreshJet FJX4233M cuenta con tres modos de funcionamiento:

Modo de funcionamiento	Descripción
Apagado	El equipo de aire acondicionado de techo está apagado.
Refrigeración	El equipo de aire acondicionado de techo enfría el interior.
Ventilación	El equipo de aire acondicionado de techo hace circular el aire sin enfriarlo.

El equipo de aire acondicionado de techo FreshJet FJX4233EEH/FJX4333E(EH)/FJX7333IHP/FJX7337IHP/FJX7457IHP cuenta con tres modos de funcionamiento:

Modo de funcionamiento	Descripción
Modo preparado	El equipo de aire acondicionado de techo está listo para funcionar y puede encenderse con el control remoto. La iluminación ambiental está disponible. El control remoto también está en modo preparado, pero se puede encender independientemente del equipo de aire acondicionado de techo.
Encendido	El equipo de aire acondicionado de techo climatiza el interior.

### 9.3 Dometic FJX4233M

La información proporcionada en este capítulo se refiere únicamente a los equipos de aire acondicionado de techo FJX4233M.

### 9.3.1 Encendido y apagado del equipo de aire acondicionado de techo

El equipo de aire acondicionado de techo tiene dos modos de aire acondicionado:

- Modo de ventilación (🌀)
- Modo de refrigeración (❄️)



**Nota** Antes de cambiar del modo de ventilación al modo de refrigeración, o viceversa, espere como mínimo 30 s. De lo contrario, la corriente de conmutación puede fundir el fusible.

Cada modo tiene tres niveles:

- ..: bajo
- ...: medio
- ....: alto

>

Para encender, gire el regulador  hasta la posición del modo de ventilación (🌀) o de refrigeración (❄️) y seleccione el nivel deseado.

- ✓ El equipo de aire acondicionado de techo está encendido y funciona con los valores establecidos antes de apagarlo.

>

Para apagar, gire el regulador  hasta la posición 0.

### 9.3.2 Ajuste de la temperatura

>

Gire el regulador  hasta la posición deseada. Al girar el regulador en sentido horario, a temperatura seleccionada es más fría.

- ✓ La temperatura ha quedado ajustada en el equipo de aire acondicionado de techo.

## 9.4 FreshJet FJX4233EEH/FJX4333E(EH)/FJX7333IHP/FJX7337IHP/FJX7457IHP

La información proporcionada en este capítulo se aplica únicamente a los equipos de aire acondicionado de techo FreshJet FJX4233EEH/FJX4333E(EH)/FJX7333IHP/FJX7337IHP/FJX7457IHP.

### 9.4.1 Con el control remoto

Tenga en cuenta los siguientes consejos al utilizar el control remoto:

- Apunte con el control remoto hacia al receptor de infrarrojos del panel de control.
- Los ajustes y valores correspondientes se transmiten directamente al equipo de aire acondicionado de techo al pulsar un botón.
- El equipo de aire acondicionado de techo confirma la recepción de los datos con un pitido.
- Los valores aumentan o disminuyen más rápido si mantiene pulsado el botón + o -.
- En el modo preparado, la pantalla del control remoto también está inactiva. Puede pasar el control remoto del modo activo al modo preparado independientemente del equipo de aire acondicionado de techo.



- > Para activar o desactivar únicamente el modo preparado del mando a distancia, pulse el botón  sin apuntar al receptor de infrarrojos del panel de control.

### 9.4.2 Encendido del equipo de aire acondicionado de techo y paso al modo preparado



**Nota** Al encender equipo de aire acondicionado de techo, funciona con los valores establecidos antes de ponerlo en modo preparado. El equipo de aire acondicionado de techo únicamente se puede apagar cortando el suministro eléctrico.





- > Pulse el botón  en el control remoto o el botón  en el panel de control para encender el equipo de aire acondicionado de techo o ponerlo en modo preparado.



### 9.4.3 Selección del modo de climatización

- > Seleccione el modo de aire acondicionado deseado con el botón MODE (Modos de aire acondicionado (solo FJX4233EEH/FJX4333E(EH)/FJX7333IHP/FJX7337IHP/FJX7457IHP) en la página 93).
- ✓ El equipo de aire acondicionado de techo confirma la recepción de los datos con un pitido. El equipo de aire acondicionado de techo conmuta al modo de aire acondicionado seleccionado.

### 9.4.4 Selección manual de la velocidad del ventilador

La velocidad del ventilador se puede seleccionar manualmente en todos los modos excepto en el modo automático (A) y el de deshumidificación (D).

Mensaje en pantalla	Descripción
	Nivel de ventilador bajo
	Nivel de ventilador medio
	Nivel de ventilador alto.
	Nivel de ventilador turbo.
	Modo automático (la velocidad del ventilador varía en función de la temperatura ambiente).

- > Pulse el botón  del control remoto o el botón  del panel de control para seleccionar la velocidad del ventilador deseada.
- ✓ El equipo de aire acondicionado de techo confirma la recepción de los datos con un pitido.

Se ha ajustado la nueva velocidad para el ventilador.

### 9.4.5 Ajuste de la temperatura

En los modos automático (A), refrigeración (❄️), calefacción (🔥) y deshumidificación (💧) es posible especificar una temperatura entre 16 °C y 31 °C.

- > Utilice el botón + o – del control remoto para establecer la temperatura deseada.
- ✓ El equipo de aire acondicionado de techo confirma la recepción de los valores con un pitido. La temperatura ha quedado ajustada en el equipo de aire acondicionado de techo.

### 9.4.6 Ajuste de la hora actual

El mando a distancia requiere la hora actual para la programación del temporizador. La hora aparece en la pantalla del control remoto.

1. Mantenga pulsado el botón (⊕) para acceder al modo de ajuste de la hora.
- ✓ La hora parpadea en la pantalla del mando a distancia.
2. Utilice los botones + y – para establecer la hora actual. Mantenga pulsado el botón + o – durante más de 2 s para aumentar o reducir el tiempo más rápidamente.
3. Pulse la tecla SET para confirmar la hora.

### 9.4.7 Ajuste del temporizador

Con la función de temporizador se puede establecer un período de tiempo específico para el aire acondicionado. Es posible establecer la hora de encendido, la hora de vuelta al modo preparado o ambos valores.









La función de temporizador se ajusta con el control remoto.





**Nota** Si mientras está programando el temporizador no pulsa ningún botón durante 15 s, el control remoto vuelve al modo inicial.

- > Establezca el **temporizador de encendido** de la siguiente manera:
  - a) Seleccione el modo de aire acondicionado deseado y el resto de valores requeridos (por ejemplo, la temperatura).
  - b) Si es necesario, ponga el equipo de aire acondicionado de techo en el modo preparado.  
El temporizador de encendido solo se puede ajustar cuando el equipo de aire acondicionado de techo está en **modo preparado**.
  - c) Pulse el botón (⊕) una vez.
  - ✓ El símbolo parpadea en la pantalla del control remoto.
  - d) Utilice el botón + o – para fijar la hora a la que se encenderá el equipo de aire acondicionado de techo.
  - e) Pulse el botón (SET).

El temporizador de encendido está fijado. El equipo de aire acondicionado de techo se encenderá con el modo seleccionado y a la hora indicada.







- > Establezca el **temporizador de modo preparado** de la siguiente manera:
  - a) Si es necesario, encienda el equipo de aire acondicionado de techo.  
El temporizador para el modo preparado solo se puede fijar si el equipo de aire acondicionado de techo está **encendido**.
  - b) Pulse el botón  dos veces.
  - ✓ El símbolo  parpadea en la pantalla del control remoto.
  - c) Utilice el botón + o – para fijar la hora a la que el equipo de aire acondicionado de techo pasará al modo preparado.
  - d) Pulse el botón .  
El temporizador para el modo preparado está fijado. El equipo de aire acondicionado de techo pasará al modo preparado a la hora indicada.
- > Establezca el **temporizador de encendido** y el **temporizador de modo preparado** de la siguiente manera:
  - a) Seleccione el modo de aire acondicionado deseado y el resto de valores requeridos (por ejemplo, la temperatura).
  - b) Pulse el botón  tres veces.
  - ✓ El símbolo  aparece en la pantalla del control remoto. El símbolo ON parpadea.
  - c) Utilice el botón + o – para fijar la hora a la que se encenderá el equipo de aire acondicionado de techo.
  - d) Pulse el botón .
  - ✓ El símbolo **OFF** parpadea.
  - e) Utilice el botón + o – para fijar la hora a la que el equipo de aire acondicionado de techo pasará al modo preparado.
  - f) Pulse el botón .
  - ✓ Las horas de encendido y de paso al modo preparado están fijadas. El equipo de aire acondicionado de techo se encenderá y funcionará durante el periodo de tiempo establecido.
- > Para **cancelar** el temporizador preestablecido, pulse una vez el botón .
- ✓ Los símbolos  desaparecen. Los valores preestablecidos se descartan.

### 9.4.8 Ajuste de la función Sleep

La función Sleep solo está disponible en los modos de refrigeración () o calefacción (.

La función Sleep limita la velocidad del ventilador a un nivel más bajo para reducir la emisión de ruido y facilitar el sueño.

**Solo FJX7333IHP/FJX7337IHP/FJX7457IHP:** La función Sleep también limita la velocidad del compresor.

- > Para activar la función Sleep, haga lo siguiente:
  - a) Establezca la temperatura deseada (Ajuste de la temperatura en la página 98).
  - b) Pulse el botón  en el control remoto o el botón  en el panel de control.
- ✓ En la pantalla del control remoto aparece el símbolo . La función Sleep está activada.
- > Para desactivar la función Sleep, pulse el botón  o  en el control remoto o el botón  en el panel de control.
- ✓ El símbolo  desaparece de la pantalla del control remoto. La función Sleep está desactivada.

### 9.4.9 Activación de la función I Feel

Cuando esta función está activada, el control remoto mide la temperatura ambiente y transmite el valor medido al equipo de aire acondicionado de techo cada 10 minutos. El equipo de aire acondicionado de techo adapta el valor de referencia a esta medición. La función I Feel solo se activa cuando la temperatura está entre +18 °C y +29 °C.

El control remoto no debería encontrarse en un área del habitáculo considerablemente más caliente o más fría que la temperatura promedio del habitáculo. Por ejemplo, no debe dejarse expuesto al sol o delante del equipo de aire acondicionado de techo.

Cuando la temperatura supera los +29 °C o desciende por debajo de los +18 °C, la función I Feel se desactiva. El símbolo  parpadea tres veces en la pantalla y se apaga.

1. Pulse el botón.
- ✓ La función I Feel está activada.

El símbolo  aparece en la pantalla.

2. Coloque el control remoto de manera que apunte hacia el receptor de infrarrojos del panel de control. De lo contrario, los datos no se transmitirán al equipo de aire acondicionado de techo.







### 9.4.10 Control de las luces ambientales



**¡ADVERTENCIA! Peligro de lesiones** Por ley, está prohibido utilizar las luces exteriores al conducir el vehículo.

El botón  del control remoto está activo aunque el control remoto esté apagado.

#### Solo Freshjet FJX4233EEH/FJX4333E(EH)/FJX7333IHP/FJX7337IHP/FJX7457IHP:

- > Para encender o apagar las luces internas, pulse el botón  del control remoto o del panel de control.
- ✓ El símbolo  parpadea una vez en la pantalla del control remoto al **encender** las luces internas.
- > Para atenuar las luces internas siga los siguientes pasos:
  - a) Pulse el botón  en el control remoto o en el panel de control durante 3 s.
  - b) Mientras pulsa el botón  en el control remoto: Pulse el botón  para atenuar la luz interna entre 50 % y 100 %.
  - c) Mientras pulsa el botón  en el panel de control: El brillo de la luz interna varía de 50 % a 100 % por ciclos. Suelte el botón  cuando se alcance el brillo deseado.

#### Solo Freshjet FJX7333IHP/FJX7337IHP/FJX7457IHP:

- > Para encender o apagar las luces externas, pulse el botón  en el panel de control.

### 9.4.11 Sustitución de las pilas del control remoto



**Nota** La pantalla del control remoto puede seguir iluminada aunque las pilas se estén agotando. Sustituya las pilas cuando el mando a distancia indique batería baja.

- > Sustituya las pilas como se muestra.

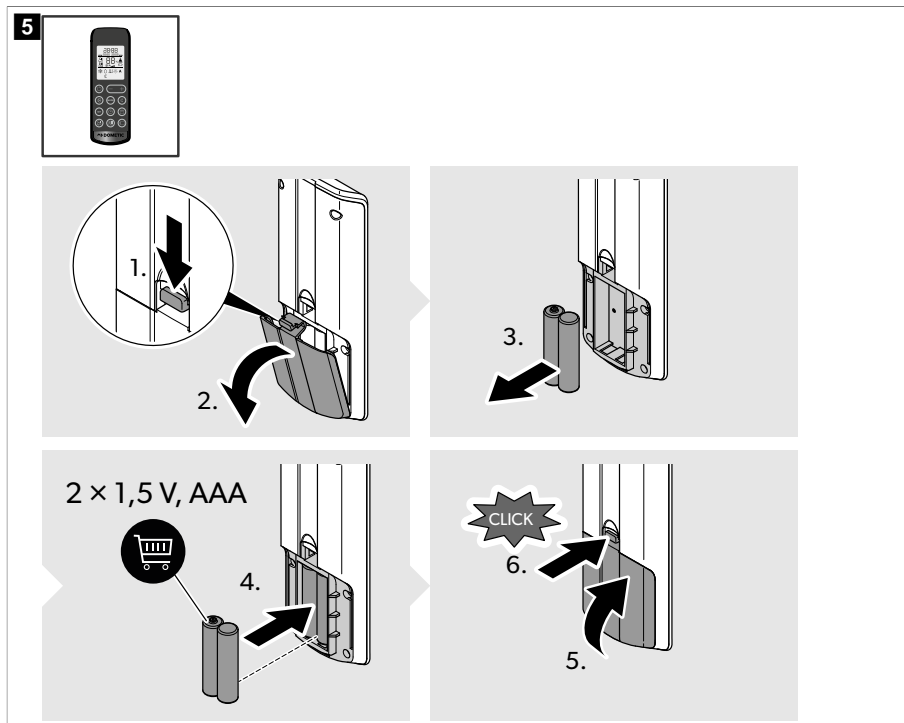

- ✓ En la pantalla aparecen todos los símbolos durante 5 s.



¡Proteja el medio ambiente! Las baterías y pilas no son basura doméstica. Entregue las baterías defectuosas o usadas en un establecimiento especializado o deposítelas en un punto de recogida de residuos.

## 9.5 Regulación del suministro de aire en el interior del vehículo

El flujo de aire se puede ajustar a lo largo del techo o hacia el suelo.

- > Gire las lamas de las boquillas de aire individualmente en la dirección deseada.

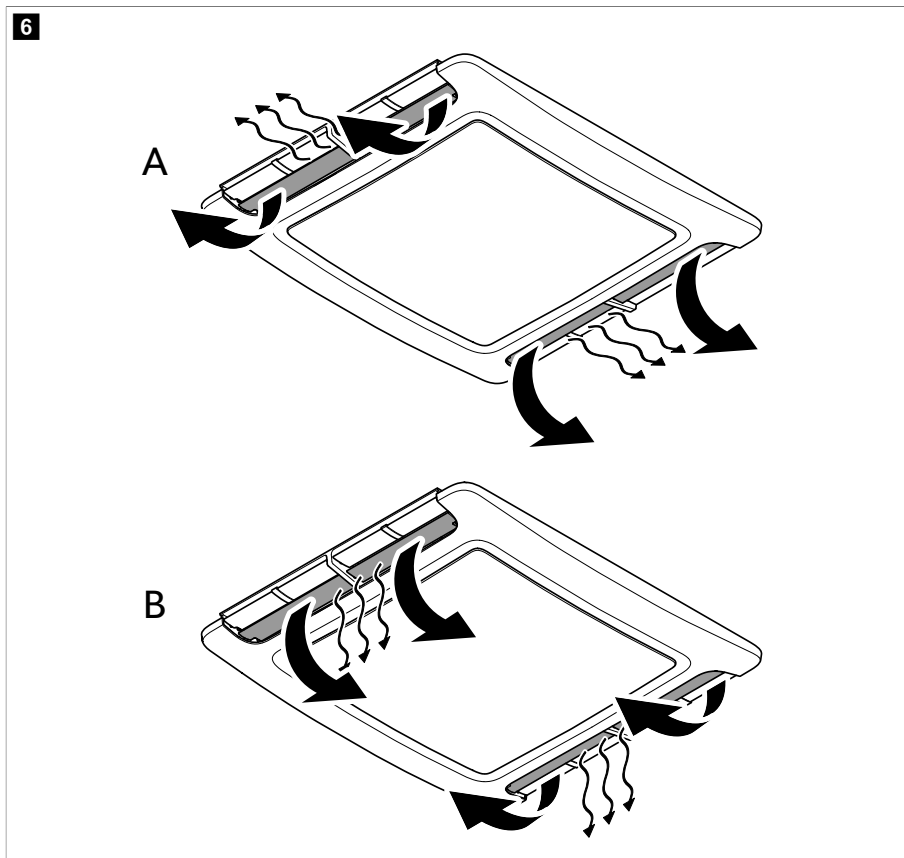

## 10 Limpieza del equipo de aire acondicionado de techo



### ¡AVISO! Peligro de daños

- Para acelerar el proceso de descongelación o limpiar el aparato, utilice solamente los procedimientos recomendados por el fabricante.
- No limpie el equipo de aire acondicionado de techo con un limpiador de alta presión. Podría dañar el equipo de aire acondicionado si penetrara agua en él.
- Para la limpieza no utilice ningún objeto afilado o duro ni detergentes, ya que ello podría dañar el equipo de aire acondicionado de techo.
- No utilice gasolina, diésel o disolventes.

1. Retire periódicamente las hojas y otros restos de suciedad de la entrada de aire y las rejillas de ventilación del equipo de aire acondicionado de techo. No dañe las rejillas de ventilación durante el proceso.

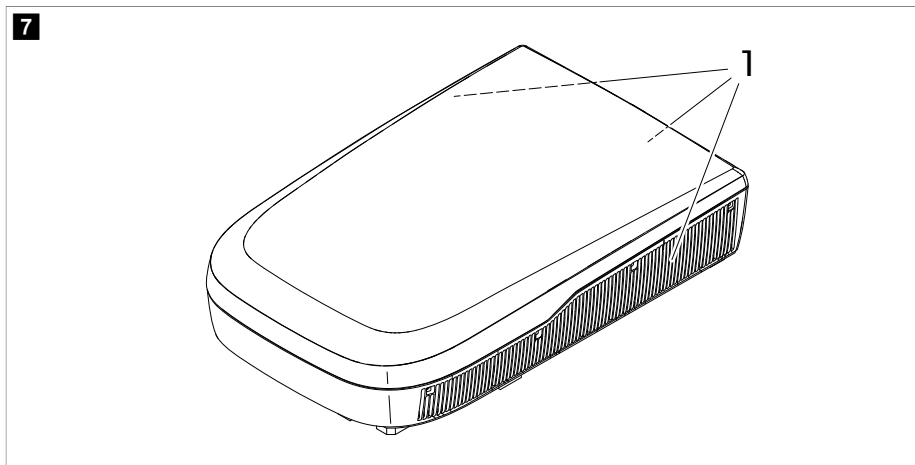

2. Limpie de vez en cuando las carcasas de la unidad superior del techo y de la caja de distribución de aire utilizando un paño húmedo. Utilice exclusivamente agua con un producto de limpieza suave.
3. **Solo FreshJet FJX4233EEH/FJX4333E(EH)/FJX7333IHP/FJX7337IHP/FJX7457IHP:** Limpie de vez en cuando el control remoto con un paño ligeramente húmedo. Limpie la pantalla con una gamuza para limpiar gafas.
4. **Solo FreshJet FJX4233EEH/FJX4333E(EH)/FJX7333IHP/FJX7337IHP/FJX7457IHP** limpiar Limpie de vez en cuando la caja de distribución de aire con una solución suave de agua jabonosa templada. La pantalla es acrílica y puede resultar dañada por algunos productos químicos domésticos de uso común, como limpiadores químicos, limpiadores de ventanas, alcohol, ciertos productos tensoactivos, disolventes orgánicos y suavizantes.

## 11 Mantenimiento

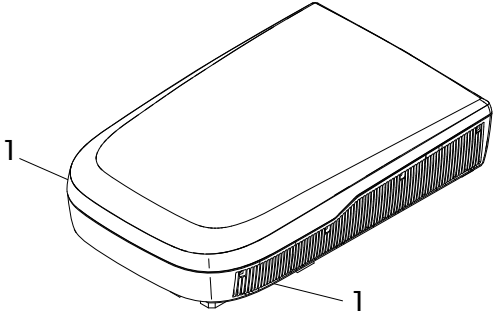
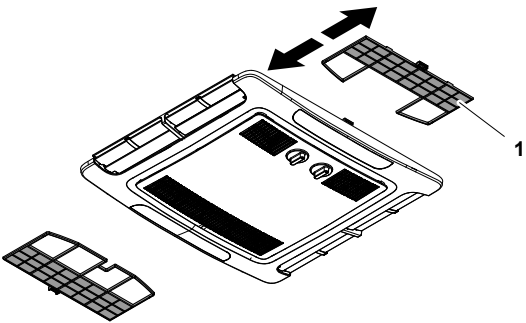

**¡ADVERTENCIA! Peligro de lesiones** Cualquier otro trabajo de mantenimiento, además de los aspectos aquí descritos, solo puede ser realizado por personal cualificado que conozca los riesgos que conlleva la manipulación de refrigerantes y sistemas de aire acondicionado, así como la normativa vigente.

Intervalo	Inspección/mantenimiento
Periódicamente	<p data-bbox="333 188 1003 252">Compruebe que los canales de salida del agua de condensación (1) situados en los laterales del equipo de aire acondicionado de techo no estén obstruidos y el agua de condensación pueda evacuar.</p> <div data-bbox="333 268 1016 639"><p data-bbox="344 277 367 304"><b>8</b></p><p data-bbox="434 437 456 464">1</p><p data-bbox="785 587 804 614">1</p></div>
Periódicamente (FreshJet FJX4233M)	<p data-bbox="333 662 684 689">Limpie el filtro de la unidad de descarga de aire.</p> <div data-bbox="333 703 1016 1070"><p data-bbox="344 713 367 740"><b>9</b></p><p data-bbox="983 868 1002 895">1</p></div> <ol data-bbox="348 1086 844 1150" style="list-style-type: none"><li data-bbox="348 1086 497 1107">1. Retire el filtro (1).</li><li data-bbox="348 1107 844 1128">2. Limpie el filtro (1) con una solución de detergente y déjelo secar.</li><li data-bbox="348 1128 628 1149">3. Vuelva a introducir el filtro seco (1).</li></ol>

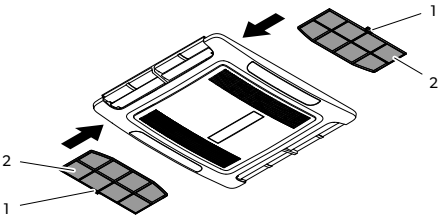

Intervalo	Inspección/mantenimiento
Periódicamente (Fresh-Jet FJX4233EEH/ FJX4333E(EH)/FJX7333IHP/ FJX7337IHP/FJX7457IHP)	<ul style="list-style-type: none"> <li>• Limpie el filtro de la unidad de descarga de aire.</li> </ul> <div data-bbox="367 225 1016 528" style="border: 1px solid black; padding: 10px; margin: 10px 0;"> <p><b>10</b></p>  <p>1. Introduzca un destornillador plano o un cuchillo en el asa (1) para extraer ligeramente los filtros (2). 2. Retire los filtros con la mano. 3. Limpie los filtros con una solución de detergente y déjelos secar. 4. Vuelva a introducir los filtros secos. fig. 10 en la página 105</p> </div> <ul style="list-style-type: none"> <li>• Diríjase a una empresa especializada para realizar mantenimiento del intercambiador de calor del equipo de aire acondicionado de techo.</li> </ul>
Una vez al año	<ul style="list-style-type: none"> <li>• Compruebe si las juntas entre el equipo de aire acondicionado de techo y el vehículo presentan fisuras u otros daños.</li> <li>• Compruebe si los pernos de fijación están fijados con el par de apriete correcto (2,5 Nm <math>\pm</math> 0,3 Nm) y ajústelos si es necesario.</li> </ul>

## 12 Solución de problemas

Fallo	Posible causa	Propuesta de solución
No enfría bien	El equipo de aire acondicionado de techo no está ajustado para enfriar.	Ajuste el equipo de aire acondicionado de techo para enfriar.
	La temperatura ambiente es superior a 52 °C.	El equipo de aire acondicionado de techo está diseñado para temperaturas ambiente de hasta 52 °C.
	La temperatura ajustada es superior a la temperatura ambiente.	Seleccione una temperatura inferior.
	La temperatura ambiente es inferior a 16 °C.	El equipo de aire acondicionado de techo está diseñado para enfriar solo con temperaturas ambiente superiores a 16 °C.
	Uno de los sensores de temperatura está averiado.	Póngase en contacto con personal de mantenimiento autorizado o con Dometic.

Fallo	Posible causa	Propuesta de solución
	El ventilador del evaporador está dañado.	Póngase en contacto con personal de mantenimiento autorizado o con Dometic.
	El ventilador del condensador está dañado.	Póngase en contacto con personal de mantenimiento autorizado o con Dometic.
<b>Solo FreshJet FJX4233EEH/ FJX4333E(EH)/FJX7333IHP/ FJX7337IHP/FJX7457IHP:</b> No calienta bien	El equipo de aire acondicionado de techo no está ajustado para calentar.	Ajuste el equipo de aire acondicionado de techo para calentar.
	La temperatura ambiente es inferior a $-2^{\circ}\text{C}$ .	El equipo de aire acondicionado de techo está diseñado para temperaturas ambiente superiores a $-2^{\circ}\text{C}$ .
	La temperatura ajustada es inferior a la temperatura ambiente.	Seleccione una temperatura superior.
	Uno de los sensores de temperatura está averiado.	Póngase en contacto con personal de mantenimiento autorizado o con Dometic.
	El ventilador del evaporador está dañado.	Póngase en contacto con personal de mantenimiento autorizado o con Dometic.
Poca salida de aire	Las aberturas de entrada de aire están bloqueadas u obstruidas.	Retire la hojarasca y demás suciedad de las rejillas de ventilación del equipo de aire acondicionado de techo.
	El ventilador está averiado.	Póngase en contacto con personal de mantenimiento autorizado o con Dometic.
Entra agua en el vehículo.	Las aberturas de salida para el agua de condensación están atascadas.	Limpie las aberturas de desagüe del agua de condensación.
	Las juntas están dañadas.	Póngase en contacto con personal de mantenimiento autorizado o con Dometic.
El equipo de aire acondicionado de techo no se enciende.	No hay ninguna fuente de alimentación conectada.	Compruebe la fuente de alimentación.
	La tensión es demasiado baja ( $< 200\text{ V}$ ).	Póngase en contacto con personal de mantenimiento autorizado o con Dometic.
	El transformador de tensión está averiado.	Póngase en contacto con personal de mantenimiento autorizado o con Dometic.
	Uno de los sensores de temperatura está averiado.	Póngase en contacto con personal de mantenimiento autorizado o con Dometic.

Fallo	Posible causa	Propuesta de solución
	El fusible eléctrico de la fuente de alimentación es demasiado débil.	Póngase en contacto con personal de mantenimiento autorizado o con Dometic.
El equipo de aire acondicionado de techo no se apaga.	Uno de los sensores de temperatura está averiado.	Póngase en contacto con personal de mantenimiento autorizado o con Dometic.
	El fusible eléctrico de la fuente de alimentación es demasiado débil.	Póngase en contacto con personal de mantenimiento autorizado o con Dometic.
<b>Solo FreshJet FJX4233EEH/ FJX4333E(EH)/FJX7333IHP/ FJX7337IHP/FJX7457IHP:</b> El equipo de aire acondicionado de techo se apaga constantemente.	El sensor de congelación ha saltado.	La temperatura exterior es demasiado baja o todas las boquillas de aire están cerradas.
La pantalla muestra: P0	Exceso de temperatura o sobrecarga en el módulo IPM	Póngase en contacto con personal de mantenimiento autorizado o con Dometic.
La pantalla muestra: P1	Protección de baja tensión	Póngase en contacto con personal de mantenimiento autorizado o con Dometic.
La pantalla muestra: P2	Protección contra sobrecarga de CA de la unidad	Póngase en contacto con personal de mantenimiento autorizado o con Dometic.
La pantalla muestra: P4	Protección contra sobrecalentamiento del tubo de descarga	Póngase en contacto con personal de mantenimiento autorizado o con Dometic.
La pantalla muestra: P5	Protección del serpentín del evaporador (modo de refrigeración)	Póngase en contacto con personal de mantenimiento autorizado o con Dometic.
La pantalla muestra: P6	Protección del serpentín del condensador (modo de refrigeración)	Póngase en contacto con personal de mantenimiento autorizado o con Dometic.
La pantalla muestra: P7	Protección del serpentín del evaporador (modo calefacción)	Póngase en contacto con personal de mantenimiento autorizado o con Dometic.
La pantalla muestra: P9	Accionamiento anómalo del compresor anormal o el compresor no arranca	Póngase en contacto con personal de mantenimiento autorizado o con Dometic.
La pantalla muestra: E0	Fallo de comunicación	Póngase en contacto con personal de mantenimiento autorizado o con Dometic.
La pantalla muestra: E1	Fallo del sensor de temperatura ambiente	Póngase en contacto con personal de mantenimiento autorizado o con Dometic.

Fallo	Posible causa	Propuesta de solución
La pantalla muestra: E2	Fallo del sensor de temperatura del serpentín del evaporador	Póngase en contacto con personal de mantenimiento autorizado o con Dometic.
La pantalla muestra: E3	Fallo del sensor de temperatura de la serpentín del condensador	Póngase en contacto con personal de mantenimiento autorizado o con Dometic.
La pantalla muestra: E7	Fallo del sensor de temperatura exterior	Póngase en contacto con personal de mantenimiento autorizado o con Dometic.
La pantalla muestra: E8	Fallo del sensor de temperatura del tubo de descarga	Póngase en contacto con personal de mantenimiento autorizado o con Dometic.
La pantalla muestra: E9	Fallo del accionamiento del compresor o del módulo IPM	Póngase en contacto con personal de mantenimiento autorizado o con Dometic.
La pantalla muestra: EA	Fallo del sensor de corriente	Póngase en contacto con personal de mantenimiento autorizado o con Dometic.
La pantalla muestra: EE	Fallo de la EEPROM exterior	Póngase en contacto con personal de mantenimiento autorizado o con Dometic.
La pantalla muestra: EL	Fallo de comunicación de LIN-BUS/CI-BUS	Póngase en contacto con personal de mantenimiento autorizado o con Dometic.

## 13 Gestión de residuos



Si es posible, deseche el material de embalaje en los contenedores de reciclaje adecuados. Consultar con un punto limpio o con un distribuidor especializado para obtener más información sobre cómo eliminar el producto de acuerdo con las normativas aplicables de eliminación.



¡Proteja el medio ambiente! Las baterías y pilas no son basura doméstica. Entregue las baterías defectuosas o usadas en un establecimiento especializado o deposítelas en un punto de recogida de residuos.

## 14 Garantía

Se aplica el período de garantía estipulado por la ley. Si el producto es defectuoso, contacte con su punto de venta (véase [dometic.com/dealer](http://dometic.com/dealer)) o con la sucursal del fabricante en su país.

Para tramitar la reparación y la garantía, incluya los siguientes documentos cuando envíe el aparato:

- Una copia de la factura con fecha de compra
- El motivo de la reclamación o una descripción de la avería

Tenga en cuenta que una reparación por medios propios o no profesionales puede tener consecuencias de seguridad y suponer la anulación de la garantía.

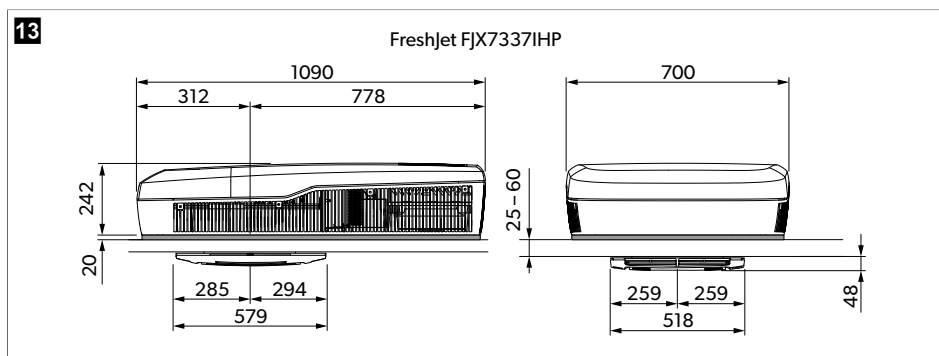
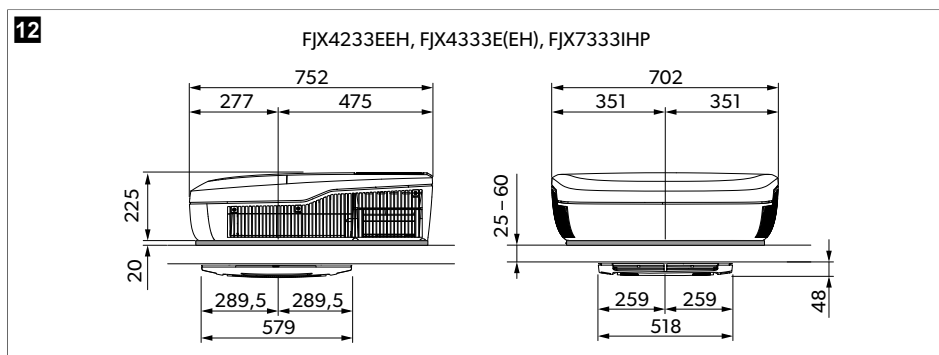
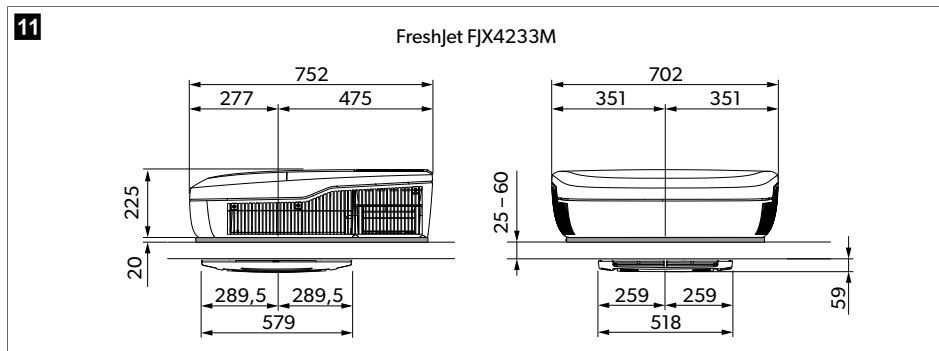

## 15 Datos técnicos

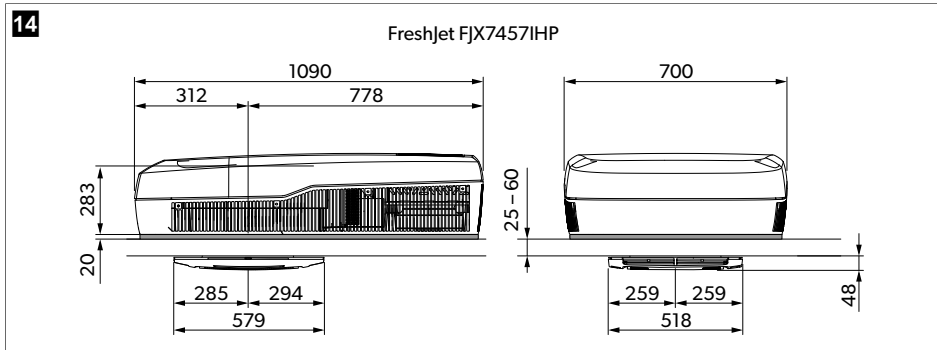



Contiene gases de efecto invernadero fluorados. Equipo herméticamente sellado.

	<b>FreshJet FJX4233M</b>
Potencia de refrigeración de conformidad con ISO 5151:	1500 W
Tensión de entrada de CA:	220 V ... 240 V / 50 Hz
Corriente nominal de refrigeración:	< 3.3 A
Fusible necesario:	4 A
Rango de temperatura de funcionamiento:	- 2 °C ... 52 °C
Refrigerante:	R410a
Cantidad de refrigerante:	380 g
Equivalente de CO <sub>2</sub> :	0.793 t
Índice GWP (Global warming potential):	2088
Clase de protección (unidad superior de techo):	IPX4
Nivel de ruido (máximo nivel del ventilador)	< 70 dB(A)
Longitud máxima recomendada del vehículo (con paredes aisladas):	< 5 m
Dimensiones L x An x Al:	fig. <b>11</b> en la página 109
Peso:	< 30 kg

	FreshJet FJX4233M		
Inspección/certificados:			
	FreshJet FJX4233EEH	FreshJet FJX4333EEH	FreshJet FJX4333E
Potencia de refrigeración de conformidad con ISO 5151:	1700 W	2200 W	2200 W
Potencia de calefacción de conformidad con ISO 5151:	800 W	1000 W	–
Tensión de entrada de CA:	220 V ... 240 V / 50 Hz		
Corriente nominal de refrigeración:	3.6 A	4.8 A	4.8 A
Corriente nominal de calefacción:	< 5.2 A	< 5.2 A	–
Fusible necesario:	4 A	5 A	6 A
Rango de temperatura de funcionamiento:	– 2 °C ... 52 °C		
Refrigerante:	R32		
Cantidad de refrigerante:	320 g	360 g	360 g
Equivalente de CO <sub>2</sub> :	0.216 t	0.243 t	0.243 t
Índice GWP (Global warming potential):	675		
Clase de protección (unidad superior de techo):	IPX4		
Nivel de ruido (máximo nivel del ventilador)	< 70 dB(A)		
Longitud máxima recomendada del vehículo (con paredes aisladas):	< 6 m	< 7 m	< 7 m
Dimensiones L x An x Al:	fig. 12 en la página 109		
Peso:	< 30 kg	< 30 kg	< 30 kg
Inspección/certificados:			

	<b>Freshjet FJX7333IHP</b>	<b>Freshjet FJX7337IHP</b>	<b>Freshjet FJX7457IHP</b>
Potencia de refrigeración de conformidad con ISO 5151:	2200 W	3000 W	3500 W
Potencia de calefacción de conformidad con ISO 5151:	2000 W	2500 W	3000 W
Tensión de entrada de CA:	220 V ... 240 V / 50 Hz ... 60 Hz	220 V ... 240 V / 50 Hz ... 60 Hz	220 V ... 240 V / 50 Hz ... 60 Hz
Corriente nominal de refrigeración:	< 7.5 A	< 7.5 A	< 7.5 A
Corriente nominal de calefacción:	< 6.1 A	< 6.1 A	< 6.1 A
Fusible necesario:	6 A	6 A	6 A
Rango de temperatura de funcionamiento:	- 2 °C ... 52 °C	- 2 °C ... 52 °C	- 2 °C ... 52 °C
Refrigerante:	R32	R32	R32
Cantidad de refrigerante:	420 g	480 g	650 g
Equivalente de CO <sub>2</sub> :	0.2835 t	0.3240 t	0.43875 t
Índice GWP (Global warming potential):		675	
Clase de protección (unidad superior de techo):		IPX4	
Nivel de ruido (máximo nivel del ventilador)		< 70 dB(A)	
Longitud máxima recomendada del vehículo (con paredes aisladas):	< 7 m	< 7 m	> 8 m
Dimensiones L x An x Al:	fig. <b>12</b> en la página 109	fig. <b>13</b> en la página 109	fig. <b>14</b> en la página 110
Peso:	< 30 kg	< 35 kg	< 40 kg
Inspección/certificados:			



## Portuguese

1	Important notes.....	113
2	Explicação dos símbolos.....	113
3	Indicações de segurança.....	114
4	Utilização adequada.....	115
5	Explicação dos símbolos no aparelho.....	116
6	Limites e condições técnicas.....	116
7	Descrição técnica.....	116
8	Antes da primeira utilização.....	123
9	Operação.....	123
10	Limpar o sistema de ar condicionado de tejadilho.....	131
11	Manutenção.....	132
12	Resolução de falhas.....	133
13	Eliminação.....	136
14	Garantia.....	136
15	Dados técnicos.....	136

## 1 Important notes

Leia atentamente as presentes instruções e siga todas as instruções, orientações e avisos incluídos neste manual, de modo a garantir a correta instalação, utilização e manutenção do produto. É OBRIGATÓRIO manter estas instruções junto com o produto.

Ao utilizar o produto, está a confirmar que leu atentamente todas as instruções, orientações e avisos, e que compreende e aceita cumprir os termos e condições estabelecidos no presente manual. Aceita utilizar este produto exclusivamente para o fim e a aplicação a que se destina e de acordo com as instruções, orientações e avisos estabelecidos neste manual, assim como de acordo com todas as leis e regulamentos aplicáveis. Caso não leia nem siga as instruções e os avisos aqui estabelecidos, poderá sofrer ferimentos pessoais ou causar ferimentos a terceiros e o produto ou outros materiais nas proximidades poderão ficar danificados. Este manual do produto, incluindo as instruções, orientações e avisos, bem como a documentação relacionada, podem estar sujeitos a alterações e atualizações. Para consultar as informações atualizadas do produto, visite [documents.dometic.com](http://documents.dometic.com).

## 2 Explicação dos símbolos



**PERIGO!** indica uma situação perigosa que, se não for evitada, resultará em morte ou ferimentos graves.



**AVISO!** indica uma situação perigosa que, se não for evitada, resultará em morte ou ferimentos graves.



**PRECAUÇÃO!** Indica uma situação perigosa que, se não for evitada, pode causar ferimentos ligeiros ou moderados.



**NOTA!** Indica uma situação perigosa que, se não for evitada, pode causar ferimentos ligeiros ou moderados.



**Observação** Informações complementares para a utilização do produto.

### 3 Indicações de segurança



**AVISO! O incumprimento destes avisos poderá resultar em morte ou ferimentos graves.**

- **Os aparelhos elétricos não são um brinquedo.** O aparelho não deve ser utilizado por pessoas (incluindo crianças) com capacidades físicas, sensoriais ou mentais reduzidas ou com experiência e conhecimento insuficientes, a menos que estejam sob supervisão ou tenham recebido instruções acerca da utilização do aparelho.
- As crianças devem ser supervisionadas, por forma a garantir que não brincam com o aparelho.
- Este aparelho pode ser utilizado por crianças a partir dos 8 anos e por pessoas com capacidades físicas, sensoriais ou mentais reduzidas ou sem experiência e conhecimento se forem supervisionadas ou tenham recebido instruções acerca da utilização do aparelho de forma segura e compreenderem os perigos implicados.
- A limpeza não pode ser efetuada por crianças sem supervisão.
- Qualquer pessoa envolvida em trabalhos num circuito de refrigeração ou na sua desmontagem deve possuir um certificado válido e atual, emitido por uma autoridade de avaliação acreditada pela indústria, que valide a competência dos envolvidos no manuseamento de agentes de refrigeração em segurança, nos termos de uma especificação de avaliação reconhecida pela indústria.
- A manutenção só deve ser realizada conforme as recomendações do fabricante do equipamento. Manutenções e reparações que exijam a assistência de outro pessoal qualificado devem ser realizadas sob a supervisão da pessoa com competência para utilizar agentes de refrigeração inflamáveis.
- O aparelho só pode ser reparado por técnicos familiarizados com os perigos inerentes e com as normas em vigor. Reparações inadequadas podem originar perigos graves. Em caso de reparação, entre em contacto com o centro de assistência técnica do seu país (consulte [dometic.com/dealer](http://dometic.com/dealer)).
- Desligue sempre a fonte de alimentação durante os trabalhos no aparelho.
- O aparelho deve ser armazenado numa divisão sem fontes de ignição em funcionamento contínuo como, por exemplo, chamas sem proteção, um aparelho a gás ou um aquecedor elétrico.
- Não fure nem queime o aparelho.
- Lembre-se de que os refrigerantes podem ser inodoros.
- Não coloque o aparelho próximo de líquidos inflamáveis nem em espaços fechados.
- Certifique-se de que não há objetos inflamáveis armazenados ou instalados nas proximidades da saída de ar. Deve ser mantida uma distância de, pelo menos, 50 cm.
- Mantenha as aberturas de ar/ventilação desobstruídas.
- Não danifique o circuito de refrigeração.
- Em circunstância alguma utilizar potenciais fontes de ignição para procurar ou detetar fugas do agente de refrigeração. Não deve ser utilizada uma tocha de halogeneto, nem qualquer outro detetor que use uma chama sem proteção.
- O sistema de ar condicionado de tejadilho deve ser instalado num veículo com uma área útil superior a 4 m<sup>2</sup>.



**PRECAUÇÃO! O incumprimento destas advertências poderá resultar em ferimentos ligeiros ou moderados.**

- Não coloque as mãos nas saídas de ar e não insira objetos estranhos no aparelho.
- Em caso de incêndio, não retire a tampa superior do aparelho. Utilize antes os agentes de extinção permitidos. Não utilize água para apagar incêndios.
- Se o cabo de alimentação estiver danificado, o mesmo tem de ser substituído pelo fabricante, por um agente de assistência ou por técnicos com qualificações equivalentes, a fim de evitar riscos.
- Caso o aparelho integre um ionizador, consulte o seu médico, se tiver alguma doença. O ionizador pode produzir ozono (O3) em pequenas quantidades. Se sofre de doenças pulmonares, asma, doenças cardíacas, doenças respiratórias e problemas respiratórios, ou se tiver sensibilidade ao ozono, consulte o seu médico para decidir se a utilização deste aparelho é segura para si.



**NOTA! Risco de danos**

- Não utilize outros métodos além dos recomendados pelo fabricante para acelerar o processo de descongelamento ou para limpar.
- O aparelho deve ser armazenado de modo a evitar danos mecânicos.
- Não deve executar quaisquer alterações ou modificações no aparelho!
- Nunca lave o veículo em sistemas de lavagem automáticos com o aparelho montado.
- Em caso de falhas no circuito de refrigeração, o aparelho tem de ser inspecionado e reparado pelo fabricante, por um agente de assistência ou por técnicos com qualificações equivalentes, a fim de evitar riscos.

## 4 Utilização adequada

O sistema de ar condicionado de tejadilho FreshJet FJX foi concebido exclusivamente para a instalação no tejadilho de uma caravana ou de um veículo de recreio para fornecer refrigeração.

O sistema de ar condicionado de tejadilho **não** é adequado para comboios, casas e apartamentos. O sistema de ar condicionado de tejadilho **não** é adequado para a montagem em máquinas para a construção civil, máquinas agrícolas ou equipamentos de trabalho semelhantes.

Este produto destina-se exclusivamente à aplicação e aos fins pretendidos com base nestas instruções.

Este manual fornece informações necessárias para proceder a uma instalação e/ou a uma operação adequadas do produto. Uma instalação e/ou uma operação ou manutenção incorretas causarão um desempenho insatisfatório e uma possível avaria.

O fabricante não aceita qualquer responsabilidade por danos ou prejuízos no produto resultantes de:

- Montagem ou ligação incorreta, incluindo sobretensões
- Manutenção incorreta ou utilização de peças sobressalentes não originais fornecidas pelo fabricante
- Alterações ao produto sem autorização expressa do fabricante
- Utilização para outras finalidades que não as descritas no presente manual

A Dometic reserva-se o direito de alterar o design e as especificações do produto.

## 5 Explicação dos símbolos no aparelho



Atenção! Material com velocidade de combustão baixa.



Leia o manual de instruções.



Leia o manual de manutenção.

## 6 Limites e condições técnicas

O sistema de ar condicionado de tejadilho está concebido para veículos com tejadilhos com uma espessura de 25 mm ... 60 mm. O funcionamento do sistema de ar condicionado de tejadilho está garantido para temperaturas ambiente entre  $-2^{\circ}\text{C}$  ...  $52^{\circ}\text{C}$ . O sistema de ar condicionado de tejadilho está concebido para ser instalado a  $\pm 10^{\circ}$  do plano horizontal. O desempenho do sistema de ar condicionado de tejadilho pode ser reduzido se o sistema estiver exposto a fortes vibrações causadas, por exemplo, por más condições da estrada.

## 7 Descrição técnica

O sistema de ar condicionado de tejadilho FreshJet FjX4233M fornece ar fresco, sem pó nem sujidade e que pode ser desumidificado, ao interior do veículo.

O sistema de ar condicionado de tejadilho FreshJet FjX4233EEH/FjX4333E(EH)/FjX7333IHP/FjX7337IHP/FjX7457IHP fornece ar fresco ou quente, sem pó nem sujidade e que pode ser desumidificado, ao interior do veículo.

O sistema de ar condicionado de tejadilho está apto para reduzir a temperatura no interior do veículo até um determinado nível que depende do tipo de veículo, da temperatura ambiente e da capacidade de refrigeração do sistema de ar condicionado de tejadilho. Quando a temperatura ambiente exterior é inferior a  $16^{\circ}\text{C}$ , o sistema de ar condicionado de tejadilho deixa de refrigerar o ar.

A operação do sistema de ar condicionado de tejadilho realiza-se com os seguintes elementos de comando:

- Painel de comando

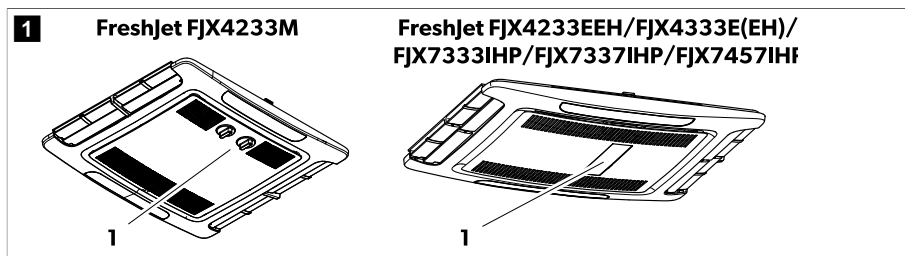

- Controlo remoto (apenas FJX4233EEH/FJX4333E(EH)/FJX7333IHP/FJX7337IHP/FJX7457IHP)

## 7.1 Lista de modelos

A tabela seguinte indica que função se aplica a cada modelo específico:



● Função disponível

○ Função atualizável

	FJX4233M	FJX4233EEH	FJX4333EEH	FJX4333E	FJX7333IHP	FJX7337IHP	FJX7457IHP
Automático		●	●	●	●	●	●
Refrigeração	●	●	●	●	●	●	●
Aquecimento		●	●	○	●	●	●
Ventilação	●	●	●	●	●	●	●
Desumidificação		●	●	●	●	●	●
Purificador de ar	○	●	●	○	●	●	●
Lâmpada ADB		●	●	○	●	●	●
Luz exterior					●	●	●
Temporizador		●	●	●	●	●	●
Sleep		●	●	●	●	●	●
Soft Start			●	○	●	●	●

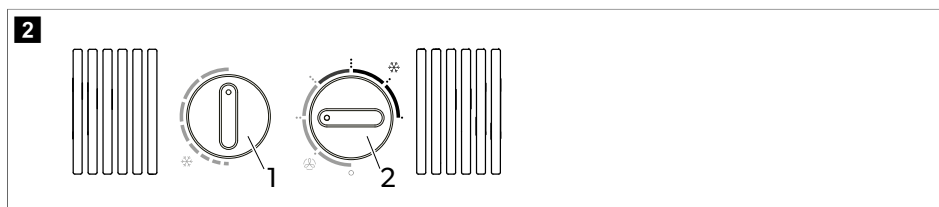







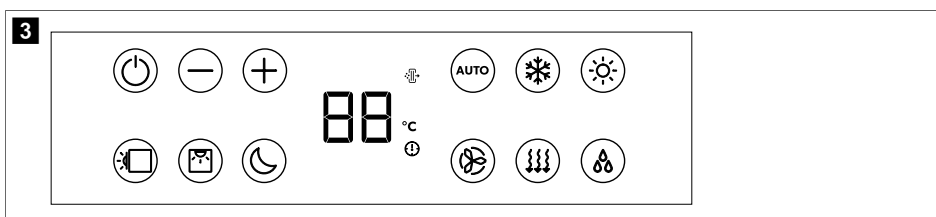

## 7.2 Painel de comando FreshJet FJX4233M









Botão rotativo	Descrição
	Seleciona a temperatura. Vire no sentido dos ponteiros do relógio para aumentar a refrigeração.
	Liga e desliga o sistema de ar condicionado de tejadilho e seleciona a intensidade da circulação de ar no modo Ventilação (🌀) ou a intensidade da refrigeração no modo Refrigerar (❄️).

### 7.3 Painel de comando FreshJet FJX4233EEH/FJX4333E(EH)/FJX7333IHP/FJX7337IHP/FJX7457IHP



Símbolo	Descrição
	Liga o sistema de ar condicionado de tejadilho ou coloca-o em modo standby.
	aumenta o valor apresentado no momento.
	reduz o valor apresentado no momento.
	Emparelha com Bluetooth/WLAN quando ambos os botões são pressionados em simultâneo.
	Liga ou desliga as luzes ambiente na unidade de tejadilho.
	Liga ou desliga as luzes ambiente na caixa de distribuição de ar.
	Ativa a função "Sleep" (Funções adicionais (apenas FJX4233EEH/FJX4333E(EH)/FJX7333IHP/FJX7337IHP/FJX7457IHP) na página 122).
	Apresenta a temperatura definida e indica o nível do ventilador quando este é ajustado.
	Indica que o modo AirPurifier está ativo.
	Indica que a temperatura é exibida em graus Celsius.
	Indica que o temporizador foi configurado.

Símbolo	Descrição
	Ativa/desativa o modo automático (Modos de climatização (apenas FJX4233EEH/FJX4333E(E-H)/FJX7333IHP/FJX7337IHP/FJX7457IHP) na página 122).
	Ativa/desativa o modo de refrigeração (Modos de climatização (apenas FJX4233EEH/FJX4333E(E-H)/FJX7333IHP/FJX7337IHP/FJX7457IHP) na página 122).
	Ativa/desativa o modo de aquecimento (Modos de climatização (apenas FJX4233EEH/FJX4333E(E-H)/FJX7333IHP/FJX7337IHP/FJX7457IHP) na página 122).
	Regula a velocidade do ventilador entre os níveis Baixo, Médio, Alto, Turbo ou Auto (apresentados como 1, 2, 3, 4 ou AA no monitor da caixa de distribuição de ar durante um curto período de tempo quando alterados).
	Ativa/desativa o modo de ventilação (Modos de climatização (apenas FJX4233EEH/FJX4333E(E-H)/FJX7333IHP/FJX7337IHP/FJX7457IHP) na página 122). Garante a circulação do ar sem aquecer ou refrigerar.
	Ativa/desativa o modo de desumidificação (Modos de climatização (apenas FJX4233EEH/FJX4333E(E-H)/FJX7333IHP/FJX7337IHP/FJX7457IHP) na página 122).

## 7.4 Controlo remoto FreshJet FJX4233EEH/FJX4333E(EH)/FJX7333IHP/ FJX7337IHP/FJX7457IHP



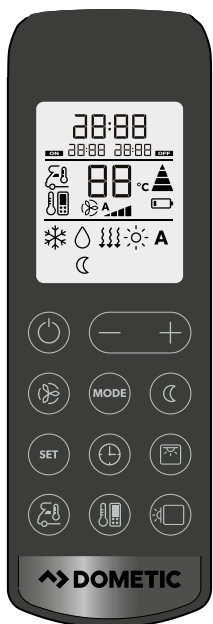











4



Elementos de comando e de indicação fig. 4 na página 120:



Botão	Descrição
—	<p><b>Mostrador</b></p> <p>É apresentado o seguinte:</p> <ul style="list-style-type: none"> <li>• Horas</li> <li>• Temperatura ambiente selecionada (valor-alvo) em °C</li> <li>• Temperatura interior atual</li> <li>• Modo de climatização</li> <li>• Velocidade do ventilador</li> <li>• Símbolos para as funções adicionais ativas</li> <li>• Estado da bateria</li> </ul>
⏻	Liga o sistema de ar condicionado de tejadilho ou alterna para o modo de standby.
⊕	aumenta o valor apresentado no momento.
⊖	reduz o valor apresentado no momento.



Botão	Descrição
	Seleciona a velocidade do ventilador (Selecionar manualmente a velocidade do ventilador na página 125).
	Seleciona o modo de climatização (Modos de climatização (apenas FJX4233EEH/FJX4333E(E-H)/FJX7333IHP/FJX7337IHP/FJX7457IHP) na página 122). É exibido o símbolo correspondente.
	Ativa a função "Sleep" (Funções adicionais (apenas FJX4233EEH/FJX4333E(EH)/FJX7333IHP/FJX7337IHP/FJX7457IHP) na página 122). É exibido o símbolo  .
	Confirma e guarda as definições.
	Programa o temporizador e o relógio.
	Liga ou desliga as luzes ambiente na caixa de distribuição de ar.
	Prima uma vez para exibir a temperatura interior atual. É exibido o símbolo  Prima duas vezes para exibir a temperatura definida.
	Ativa a função "I feel". É exibido o símbolo  A cada 10 min minutos, a função "I feel" ajusta a temperatura selecionada à temperatura atual medida pelo controlo remoto.
	Liga ou desliga as luzes ambiente na unidade de tejadilho.
	Indica que as pilhas do controlo remoto estão vazias. Substitua as pilhas (Substituir as pilhas do controlo remoto na página 129).
	Indica que o controlo remoto está a enviar valores para o sistema de ar condicionado de tejadilho.





## 7.5 Modos de climatização (apenas FJX4233M)

O sistema de ar condicionado de tejadilho tem os seguintes modos de climatização:

Modo de climatização	Símbolo exibido	Descrição
Refrigeração		Determine a temperatura e as definições do ventilador e o sistema de ar condicionado de tejadilho refrigera o interior do veículo a essa temperatura.
Ventilação		Determine as definições do ventilador e o sistema de ar condicionado de tejadilho começa a fazer circular ar sem aquecer ou refrigerar.





## 7.6 Modos de climatização (apenas FJX4233EEH/FJX4333E(EH)/FJX7333IHP/FJX7337IHP/FJX7457IHP)

O sistema de ar condicionado de tejadilho tem os seguintes modos de climatização:

Modo de climatização	Símbolo exibido	Descrição
Automático	<b>A</b>	Determine a temperatura e o sistema de ar condicionado de tejadilho aquece/refrigera o interior do veículo a essa temperatura e controla a velocidade do ventilador.
Refrigeração		Determine a temperatura e as definições do ventilador e o sistema de ar condicionado de tejadilho refrigera o interior do veículo a essa temperatura.
Aquecimento		<b>Exceto FJX4333E:</b> Determine a temperatura e as definições do ventilador e o sistema de ar condicionado de tejadilho aquece o interior do veículo a essa temperatura. O ventilador só começa a trabalhar 2 min depois (a baixa velocidade) e só aproximadamente 5 min depois passa à velocidade definida (depois de o evaporador atingir a temperatura determinada).
Ventilação		Determine as definições do ventilador e o sistema de ar condicionado de tejadilho começa a fazer circular ar sem aquecer ou refrigerar.
Desumidificação do ar		O sistema de ar condicionado de tejadilho remove a humidade do ar sem aquecer ou refrigerar o interior, reduzindo assim a humidade relativa do ar.
Purificador de ar		<b>Exceto FJX4333E:</b> O sistema de ar condicionado de tejadilho ioniza o ar, recolhendo do ar pó e partículas, incluindo vírus e bactérias.

## 7.7 Funções adicionais (apenas FJX4233EEH/FJX4333E(EH)/FJX7333IHP/FJX7337IHP/FJX7457IHP)

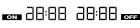
O sistema de ar condicionado de tejadilho tem as seguintes funções:

Função adicional	Mensagem no mostrador	Descrição
Temporizador		O sistema de ar condicionado de tejadilho liga-se à hora definida.
		O sistema de ar condicionado de tejadilho desliga-se à hora definida.
		O sistema de ar condicionado de tejadilho liga-se e desliga-se às horas definidas.
Sleep		A função "Sleep" reduz a velocidade do ventilador e do compressor para reduzir os níveis de ruído para que possa dormir com maior conforto.

Função adicional	Mensagem no mostrador	Descrição
I Feel		O controlo remoto mede a temperatura ambiente e transmite esta medição ao sistema de ar condicionado de tejadilho, a cada 10 min. O sistema de ar condicionado de tejadilho ajusta a temperatura desejada a esta medição.
Soft Start		<b>Exceto FJX4233EEH:</b> A corrente de pico que o arranque do compressor produz é reduzida pela função Soft start. Se for utilizado um gerador como fonte de alimentação, o gerador não deve ser sobrecarregado.

## 8 Antes da primeira utilização

### Inspeção antes da colocação em funcionamento

Antes de ligar o sistema de ar condicionado de tejadilho, tenha em consideração o seguinte:

1. Verifique se a tensão de alimentação e a frequência correspondem aos valores especificados nos Dados técnicos na página 136.
2. Certifique-se de que tanto as aberturas de entrada do ar, como os bocais de ar estão desobstruídos. Todas as grelhas de ventilação têm de ser mantidas desobstruídas para garantir que o sistema de ar condicionado de tejadilho funciona na sua capacidade máxima.

### Preparar o controlo remoto (apenas FreshJet FJX4233EEH/FJX4333E(EH)/FJX7333IHP/FJX7337IHP/FJX7457IHP)

3. Insira as pilhas (Substituir as pilhas do controlo remoto na página 129).

### Defina a hora (apenas FreshJet FJX4233EEH/FJX4333E(EH)/FJX7333IHP/FJX7337IHP/FJX7457IHP)

4. Defina a hora atual (Definir a hora atual na página 126).

## 9 Operação

### 9.1 Indicações para uma melhor utilização

As indicações seguintes irão otimizar o desempenho do seu sistema de ar condicionado de tejadilho:

- Melhore o isolamento térmico do veículo, vedando as fissuras e pendurando estores refletores ou cortinas na janela.
- Escolha uma temperatura adequada e um nível de ventilação apropriado.
- Alinhe os bocais de ar de modo conveniente.
- Assegure que os bocais de ar e as aberturas de entrada de ar não estão cobertos por panos, papéis ou outros objetos.
- **Apenas FreshJet FJX4233EEH/FJX4333E(EH)/FJX7333IHP/FJX7337IHP/FJX7457IHP:** Se o veículo tiver sido exposto à luz solar direta durante um longo período de tempo: Coloque o sistema de ar condicionado de tejadilho em funcionamento no modo Ventilação (☼☼☼) com as janelas abertas durante algum tempo antes de ligar o modo Refrigeração (❄️).
- **Apenas FreshJet FJX4233EEH/FJX4333E(EH)/FJX7333IHP/FJX7337IHP/FJX7457IHP:** Se possível, evite abrir as portas e as janelas no modo Refrigeração (❄️).

## 9.2 Indicações básicas relativas à operação

O sistema de ar condicionado de tejadilho FreshJet FJX4233M tem três modos de funcionamento:

Modo de funcionamento	Descrição
Off	O sistema de ar condicionado de tejadilho está desligado.
Refrigeração	O sistema de ar condicionado de tejadilho refrigera o interior.
Ventilação	O sistema de ar condicionado de tejadilho faz o ar circular sem refrigerar.

O sistema de ar condicionado de tejadilho FreshJet FJX4233EEH/FJX4333E(EH)/FJX7333IHP/FJX7337IHP/FJX7457IHP tem dois modos de funcionamento:

Modo de funcionamento	Descrição
Standby	O sistema de ar condicionado de tejadilho está operacional e pode ser ligado com o controlo remoto. As luzes ambiente estão disponíveis. O controlo remoto também está em standby, mas é possível ligar o controlo remoto independentemente do sistema de ar condicionado de tejadilho.
On	O sistema de ar condicionado de tejadilho condiciona o ar no interior do veículo.

## 9.3 Dometic FJX4233M

A informação disponibilizada neste capítulo refere-se apenas aos sistemas de ar condicionado de tejadilho FJX4233M.

### 9.3.1 Ligar e desligar o sistema de ar condicionado de tejadilho

O sistema de ar condicionado de tejadilho tem dois modos de climatização:

- Modo Ventilação (🌀)
- Modo Refrigeração (❄️)



**Observação** Antes de mudar do modo Ventilação para o modo Refrigeração ou vice-versa, aguarde pelo menos 30 s. Caso contrário, a corrente de comutação pode queimar o fusível.

Cada modo apresenta três definições:

- ..: Baixa
- ...: Média
- ...: Alta

>



Para ligar, vire o botão rotativo para a posição do modo Ventilação (🌀) ou para a posição do modo Refrigeração (❄️) e selecione a definição pretendida.

- ✓ O sistema de ar condicionado de tejadilho está ligado e funciona com os valores definidos antes de desligar.

&gt;

Para desligar, rode o botão rotativo  para a posição 0.

### 9.3.2 Definir a temperatura

&gt;

Rode o botão rotativo  para a posição pretendida. Se rodar o botão rotativo no sentido dos ponteiros do relógio, obtém uma temperatura mais baixa.

- ✓ A temperatura está definida no sistema de ar condicionado de tejadilho.

## 9.4 FreshJet FJX4233EEH/FJX4333E(EH)/FJX7333IHP/FJX7337IHP/FJX7457IHP

A informação disponibilizada neste capítulo refere-se apenas aos sistemas de ar condicionado de tejadilho FreshJet FJX4233EEH/FJX4333E(EH)/FJX7333IHP/FJX7337IHP/FJX7457IHP.

### 9.4.1 Através do controlo remoto

Tenha em consideração as seguintes indicações ao utilizar o controlo remoto:

- Aponte o controlo remoto para o recetor IV do painel de comando.
  - Quando preme um botão, as definições e valores correspondentes são diretamente transmitidos para o sistema de ar condicionado de tejadilho.
  - O sistema de ar condicionado de tejadilho confirma a receção dos dados emitindo um sinal sonoro.
  - Os valores aumentam ou reduzem mais rapidamente se mantiver o botão + ou – premido.
  - No modo standby, o monitor do controlo remoto também está inativo. Pode colocar o controlo remoto em standby independentemente do sistema de ar condicionado de tejadilho.
- > Para ativar ou desativar o standby apenas no controlo remoto, prima o botão  sem apontar para o recetor IV do painel de comando.

### 9.4.2 Ligar o sistema de ar condicionado de tejadilho e ativar o standby



**Observação** Quando o sistema de ar condicionado de tejadilho está ligado, o aparelho funciona com os valores definidos antes de passar para standby. O sistema de ar condicionado de tejadilho apenas pode ser desligado se cortar o fornecimento de energia.





- > Prima o botão  no controlo remoto ou o botão  no painel de comando para ligar o sistema de ar condicionado de tejadilho ou passá-lo para standby.



### 9.4.3 Selecionar o modo de climatização

- > Selecione o modo de climatização pretendido através do botão MODE (Modos de climatização (apenas FJX4233EEH/FJX4333E(EH)/FJX7333IHP/FJX7337IHP/FJX7457IHP) na página 122).
- ✓ O sistema de ar condicionado de tejadilho confirma a receção dos valores emitindo um sinal sonoro. O sistema de ar condicionado de tejadilho é ligado no modo de climatização selecionado.



### 9.4.4 Selecionar manualmente a velocidade do ventilador

É possível selecionar manualmente a velocidade do ventilador em todos os modos, exceto no modo Automático (A) e Desumidificação (D).

Mensagem no mostrador	Descrição
	Nível do ventilador baixo
	Nível do ventilador médio
	Nível do ventilador alto.
	Nível do ventilador turbo.
	Modo Automático (a velocidade do ventilador é ajustada a partir da temperatura ambiente).

- > Prima o botão  do controlo remoto ou o botão  do painel de comando para selecionar a velocidade do ventilador pretendida.
- ✓ O sistema de ar condicionado de tejadilho confirma a receção dos valores emitindo um sinal sonoro.  
A nova velocidade do ventilador é definida.

#### 9.4.5 Definir a temperatura

Nos modos Automático (**A**), Refrigeração () , Aquecimento () e Desumidificação () , é possível especificar uma temperatura entre 16 °C e 31 °C.

- > Utilize o botão + ou – do controlo remoto para definir a temperatura pretendida.
- ✓ O sistema de ar condicionado de tejadilho confirma a receção dos valores emitindo um som agudo. A temperatura está definida no sistema de ar condicionado de tejadilho.

#### 9.4.6 Definir a hora atual

O controlo remoto requer a hora atual para a programação do temporizador. A hora é exibida no monitor do controlo remoto.

1. Prima o botão  e mantenha-o premido para aceder ao modo de definição da hora.
- ✓ A hora pisca no mostrador do controlo remoto.
2. Defina a hora atual com o botão + ou –. Prima o botão + ou – e mantenha-o premido mais de 2 s para aumentar ou reduzir a hora mais rapidamente.
3. Prima o botão SET para confirmar a hora.

#### 9.4.7 Programar o temporizador



Com a função do temporizador, poderá configurar um período pretendido para a climatização. É possível definir a hora de ativação, a hora de passagem para standby ou ambos os valores.

O funcionamento do temporizador é definido através do controlo remoto.



**Observação** Se, no momento da programação do temporizador, nenhum botão do controlo remoto for premido durante 15 s, este volta a mudar para o modo inicial.



- > Programe o **temporizador de ativação** da seguinte forma:
  - a) Selecione o modo de climatização pretendido e todos os valores necessários (por exemplo, a temperatura).
  - b) Se necessário, coloque o sistema de ar condicionado de tejadilho em standby.
 

O temporizador de ativação só pode ser programado se o sistema de ar condicionado de tejadilho estiver em **standby**.
  - c) Prima uma vez o botão .
  - ✓ O símbolo  pisca no monitor do controlo remoto.
  - d) Defina as horas em que deve ser ligado o sistema de ar condicionado de tejadilho com o botão + ou -.
  - e) Prima o botão .







O temporizador de ativação está programado. O sistema de ar condicionado de tejadilho será ligado com o modo de

climatização selecionado à hora definida.



- > Programe o **temporizador de passagem para standby** da seguinte forma:
  - a) Se necessário, ligue o sistema de ar condicionado de tejadilho.
 

O temporizador de passagem para standby só pode ser programado se o sistema de ar condicionado de tejadilho estiver **ligado**.
  - b) Prima o botão  duas vezes.
  - ✓ O símbolo  pisca no monitor do controlo remoto.
  - c) Programe as horas em que o sistema de ar condicionado de tejadilho deve passar para standby com o botão + ou -.
  - d) Prima o botão .

O temporizador de passagem para standby está programado. O sistema de ar condicionado de tejadilho passará para standby à hora definida.







- > Programe o **temporizador de ativação** e o **temporizador de passagem para standby** da seguinte forma:
  - a) Selecione o modo de climatização pretendido e todos os valores necessários (por exemplo, a temperatura).
  - b) Prima o botão  três vezes.
  - ✓ O símbolo  é exibido no monitor do controlo remoto. O símbolo ON pisca.
  - c) Defina as horas em que deve ser ligado o sistema de ar condicionado de tejadilho com o botão + ou -.
  - d) Prima o botão .
  - ✓ O símbolo **OFF** pisca.
  - e) Programe as horas em que o sistema de ar condicionado de tejadilho deve passar para standby com o botão + ou -.
  - f) Prima o botão .
  - ✓ O temporizador de ativação e o temporizador de passagem para standby estão programados. O sistema de ar condicionado de tejadilho estará ligado durante o período de tempo definido.
  - > Para **cancelar** o temporizador pré-programado, prima o botão  uma vez.
  - ✓ Os símbolos   desaparecem. Os valores pré-programados são eliminados.

## 9.4.8 Ativar a função "Sleep"

A função "Sleep" está disponível apenas nos modos Refrigeração  ou Aquecimento .

A função "Sleep" limita a velocidade do ventilador para um nível mais baixo de forma a reduzir os níveis de ruído para que possa dormir melhor.

**Apenas FJX7333IHP/FJX7337IHP/FJX7457IHP:** A função "Sleep" limita adicionalmente a velocidade do compressor.

- > Proceda do seguinte modo para ativar a função "Sleep":
  - a) Defina a temperatura pretendida (Definir a temperatura na página 126).
  - b) Prima o botão  no controlo remoto ou o botão  no painel de comando.
- ✓ O símbolo  é exibido no monitor do controlo remoto. A função "Sleep" está ativada.
- > Para desativar a função "Sleep", prima o botão  ou o botão  no controlo remoto ou o botão  no painel de comando.
- ✓ O símbolo  desaparece do monitor do controlo remoto. A função "Sleep" está desativada.

### 9.4.9 Ativar a função "I feel"

Quando esta função está ativa, o controlo remoto mede a temperatura ambiente e, a cada 10 minutos, transmite esta medição ao sistema de ar condicionado de tejadilho. O sistema de ar condicionado de tejadilho ajusta a temperatura desejada a esta medição. A função "I feel" só está ativa se a temperatura estiver entre +18 °C e +29 °C.

O controlo remoto não deve encontrar-se numa área do habitáculo consideravelmente mais quente ou mais fria do que a temperatura média do habitáculo. Não pode, por exemplo, ficar ao sol ou à frente do sistema de ar condicionado de tejadilho.

Quando a temperatura é superior a +29 °C ou inferior a +18 °C, a função "I feel" é desativada. O símbolo  pisca três vezes no monitor e depois desliga-se.

1. Prima o botão.
- ✓ A função "I feel" está ativada.
  - O símbolo  é apresentado no monitor.
2. Posicione o controlo remoto de tal modo que este aponte para o recetor de IV no painel de comando. Caso contrário, não é possível transmitir os valores para o sistema de ar condicionado de tejadilho.









### 9.4.10 Operar as luzes ambiente



**AVISO! Perigo de ferimentos** É proibido por lei utilizar as luzes exteriores durante a condução do veículo.

O botão  do controlo remoto está ativo mesmo que este esteja desligado.

**Apenas FreshJet FJX4233EEH/FJX4333E(EH)/FJX7333IHP/FJX7337IHP/FJX7457IHP:**

- > Para ligar ou desligar as luzes interiores, prima o botão  no controlo remoto ou no painel de comando.
- ✓ O símbolo  pisca uma vez no monitor do controlo remoto quando as luzes interiores estão **ligadas**.
- > Para ajustar as luzes interiores, proceda da seguinte forma:
  - a) Prima o botão  no controlo remoto ou no painel de comando durante 3 s.
  - b) Ao premir o botão  no controlo remoto: prima o botão   para ajustar as luzes interiores entre 50 % e 100 %.
  - c) Ao premir o botão  no painel de comando: a luminosidade das luzes interiores varia entre 50 % e 100 %. Solte o botão  quando alcançar a luminosidade desejada.



**Apenas FreshJet FJX7333IHP/FJX7337IHP/FJX7457IHP:**

- > Para ligar e desligar as luzes exteriores, prima o botão  no painel de comando.

**9.4.11 Substituir as pilhas do controlo remoto**

**Observação** O monitor do controlo remoto poderá continuar aceso mesmo que as pilhas estejam a ficar fracas. Substitua as pilhas quando o controlo remoto indicar que as pilhas estão fracas.

- > Substitua as pilhas conforme ilustrado.

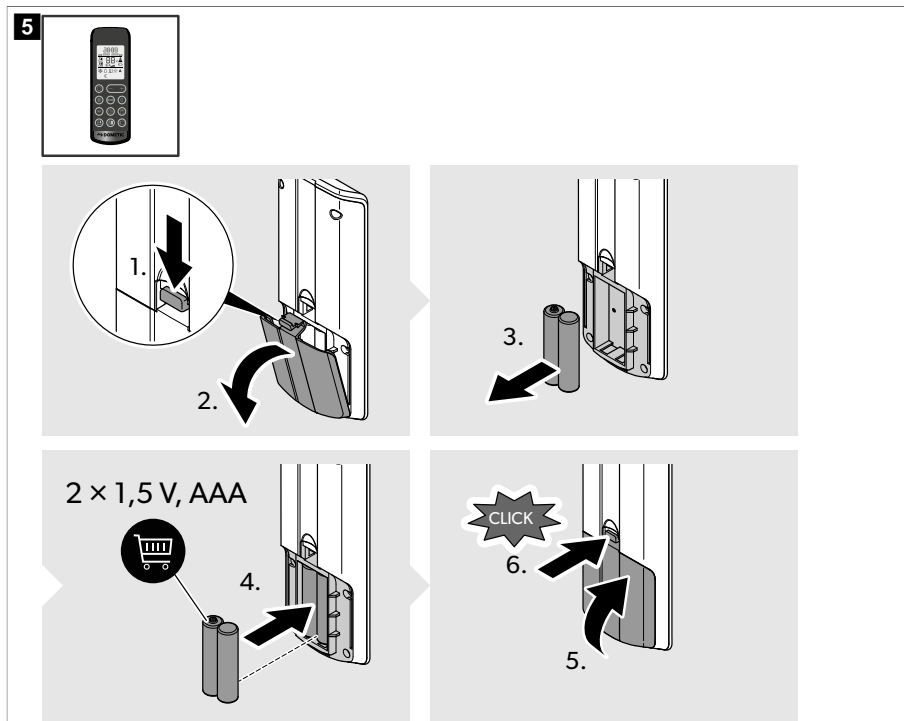

- ✓ O monitor apresenta todos os símbolos durante 5 s.



Proteja o meio ambiente! Os acumuladores e pilhas não devem ser eliminados juntamente com o lixo doméstico. Entregue os seus acumuladores danificados ou pilhas gastas numa loja ou centro de recolha.

**9.5 Regular o fornecimento de ar no interior do veículo**

O fluxo de ar pode ser ajustado ao longo do teto ou em direção ao chão.

- > Vire as lâminas dos bocais de ar nas direções pretendidas de forma independente.

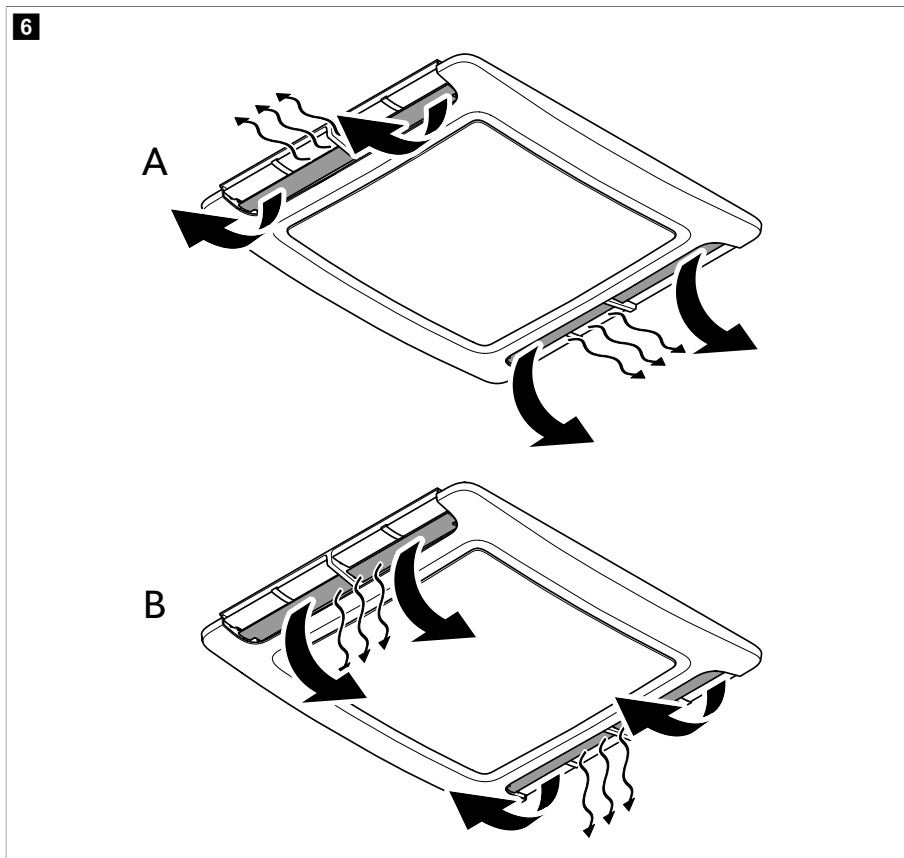

## 10 Limpar o sistema de ar condicionado de tejadilho



### NOTA! Risco de danos

- Não utilize outros métodos além dos recomendados pelo fabricante para acelerar o processo de descongelamento ou para limpar.
- Nunca limpe o sistema de ar condicionado de tejadilho com um aparelho de limpeza de alta pressão. A penetração de água pode danificar o sistema de climatização de tejadilho.
- Para a limpeza, não utilize objetos afiados ou duros, nem produtos de limpeza, uma vez que estes podem danificar o sistema de ar condicionado de tejadilho.
- Nunca utilize gasolina, gasóleo ou solventes.

1. Remova regularmente folhas e outra sujidade das grelhas de entrada de ar e de ventilação do sistema de ar condicionado de tejadilho. Durante este procedimento, não danifique as grelhas de ventilação.

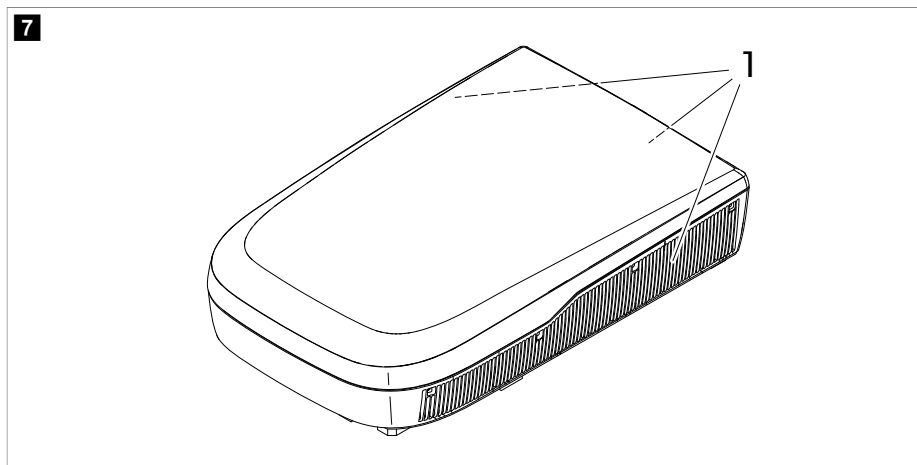

2. De vez em quando, limpe as caixas do sistema de climatização de tejadilho e da caixa de distribuição de ar com um pano húmido. Utilize apenas água com um agente de limpeza suave.
3. **Apenas FreshJet FJX4233EEH/FJX4333E(EH)/FJX7333IHP/FJX7337IHP/FJX7457IHP:** De vez em quando, limpe o controlo remoto com um pano ligeiramente húmido. Limpe o monitor com um pano de limpeza específico para vidros.
4. **Apenas FreshJet FJX4233EEH/FJX4333E(EH)/FJX7333IHP/FJX7337IHP/FJX7457IHP** De vez em quando, limpe o monitor da caixa de distribuição de ar com uma solução suave de água morna com sabão. O mostrador do monitor é em acrílico e pode ser danificado por alguns produtos químicos de uso doméstico como, por exemplo, produtos de limpeza químicos, produtos para limpar janelas, álcool, determinados tensoativos, solventes orgânicos e amaciadores.

## 11 Manutenção

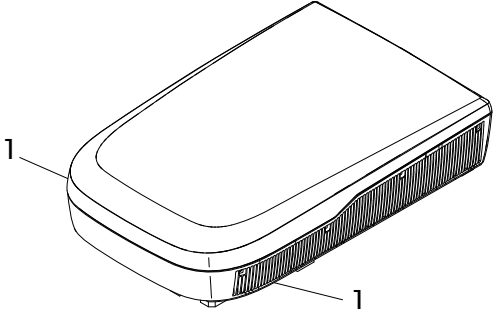
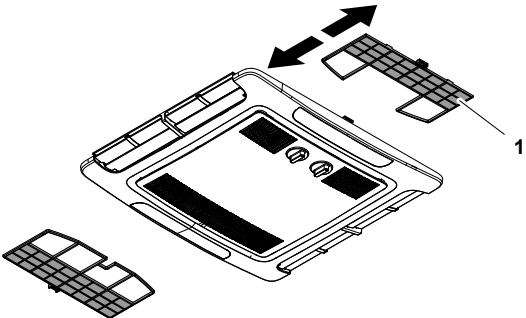

**AVISO! Perigo de ferimentos** Outros trabalhos de manutenção, para além dos temas descritos, apenas devem ser realizados por técnicos especializados familiarizados com os perigos inerentes aos trabalhos em sistemas de ar condicionado, ao manuseamento de um agente de refrigeração e com as normas em vigor.

Intervalo	Verificação/manutenção
Regularmente	<p data-bbox="333 379 1015 419">Verifique se os canais de saída da água de condensação (1) nas partes laterais do sistema de ar condicionado de tejadilho estão desobstruídos e se a água de condensação pode sair.</p> <div data-bbox="333 437 1015 804"> <p data-bbox="344 443 367 475"><b>8</b></p>  </div>
Regularmente (FreshJet FJX4233M)	<p data-bbox="333 834 654 850">Limpe o filtro da unidade de descarga de ar.</p> <div data-bbox="333 868 1015 1235"> <p data-bbox="344 874 367 906"><b>9</b></p>  </div> <ol data-bbox="348 1251 717 1315" style="list-style-type: none"> <li>1. Retire o filtro (1).</li> <li>2. Limpe o filtro (1) com detergente e deixe secar.</li> <li>3. Volte a inserir o filtro seco (1).</li> </ol>

Intervalo	Verificação/manutenção
Regularmente (Fresh-Jet FJX4233EEH/ FJX4333E(EH)/FJX7333IHP/ FJX7337IHP/FJX7457IHP)	<ul style="list-style-type: none"> <li>Limpe o filtro da unidade de descarga de ar.</li> </ul> <div data-bbox="367 225 1016 528" style="border: 1px solid black; padding: 10px; margin: 10px 0;"> <p><b>10</b></p> </div> <ol style="list-style-type: none"> <li>Introduza uma chave de parafusos com a ponta plana ou uma faca na pega (1) para puxar os filtros (2) ligeiramente para fora.</li> <li>Remova os filtros manualmente.</li> <li>Limpe os filtros com uma solução detergente e deixe-os secar.</li> <li>Empurre os filtros secos novamente para dentro, fig. 10 na página 133</li> </ol> <ul style="list-style-type: none"> <li>Solicite a manutenção dos permutadores térmicos do sistema de ar condicionado de tejadilho a uma empresa especializada.</li> </ul>
Uma vez por ano	<ul style="list-style-type: none"> <li>Inspeccione os vedantes entre o sistema de ar condicionado de tejadilho e o tejadilho do veículo quanto a fendas e outros danos.</li> <li>Verifique se os parafusos de fixação estão apertados com o binário de aperto correto (2.5 Nm ± 0.3 Nm) e ajuste, se necessário.</li> </ul>

## 12 Resolução de falhas

Falha	Possível causa	Sugestão de solução
Não refrigera corretamente	O sistema de ar condicionado de tejadilho não está regulado para o modo de refrigeração.	Regule o sistema de ar condicionado de tejadilho para o modo de refrigeração.
	A temperatura ambiente é superior a 52 °C.	O sistema de ar condicionado de tejadilho foi concebido apenas para temperaturas ambientes máximas de 52 °C.
	A temperatura definida é superior à temperatura ambiente.	Selecione uma temperatura inferior.
	A temperatura ambiente é inferior a 16 °C.	O modo de refrigeração do sistema de ar condicionado de tejadilho foi concebido para funcionar apenas a temperaturas ambiente superiores a 16 °C.
	Um dos sensores de temperatura está danificado.	Contacte um agente de assistência autorizado ou a Dometic.

Falha	Possível causa	Sugestão de solução
	O ventilador do evaporador está danificado.	Contacte um agente de assistência autorizado ou a Dometic.
	O ventilador do condensador está danificado.	Contacte um agente de assistência autorizado ou a Dometic.
<b>Apenas FreshJet FJX4233EEH/ FJX4333E(EH)/FJX7333IHP/ FJX7337IHP/FJX7457IHP:</b> Não aquece corretamente	O sistema de ar condicionado de tejadilho não está definido para o modo de aquecimento.	Regule o sistema de ar condicionado de tejadilho para o modo de aquecimento.
	A temperatura ambiente é inferior a $-2^{\circ}\text{C}$ .	O sistema de ar condicionado de tejadilho foi concebido para temperaturas ambientes acima de $-2^{\circ}\text{C}$ .
	A temperatura definida é inferior à temperatura ambiente.	Selecione uma temperatura superior.
	Um dos sensores de temperatura está danificado.	Contacte um agente de assistência autorizado ou a Dometic.
	O ventilador do evaporador está danificado.	Contacte um agente de assistência autorizado ou a Dometic.
Saída de ar reduzida	As aberturas de entrada de ar estão bloqueadas ou obstruídas.	Remova folhas e outra sujidade das grelhas de ventilação do sistema de ar condicionado de tejadilho.
	O ventilador está danificado.	Contacte um agente de assistência autorizado ou a Dometic.
Entra água para o veículo	As aberturas para saída da água de condensação estão obstruídas.	Limpe a água de condensação das aberturas para saída da água.
	As vedações estão danificadas.	Contacte um agente de assistência autorizado ou a Dometic.
O sistema de ar condicionado de tejadilho não liga.	A fonte de alimentação não está ligada.	Verifique a alimentação de corrente.
	A tensão é demasiado baixa ( $< 200\text{ V}$ ).	Contacte um agente de assistência autorizado ou a Dometic.
	O transformador de tensão está danificado.	Contacte um agente de assistência autorizado ou a Dometic.
	Um dos sensores de temperatura está danificado.	Contacte um agente de assistência autorizado ou a Dometic.
	O fusível elétrico da fonte de alimentação é muito baixo.	Contacte um agente de assistência autorizado ou a Dometic.
O sistema de ar condicionado de tejadilho não desliga.	Um dos sensores de temperatura está danificado.	Contacte um agente de assistência autorizado ou a Dometic.
	O fusível elétrico da fonte de alimentação é muito baixo.	Contacte um agente de assistência autorizado ou a Dometic.

Falha	Possível causa	Sugestão de solução
<b>Apenas FreshJet FJX4233EEH/ FJX4333E(EH)/FJX7333IHP/ FJX7337IHP/FJX7457IHP:</b> O sistema de ar condicionado de tejadilho desliga-se constantemente.	O sensor de congelação foi ativado.	A temperatura exterior é demasiado baixa ou todos os bocais de ar estão fechados.
O mostrador apresenta: P0	Sobreaquecimento ou sobretensão no módulo IPM	Contacte um agente de assistência autorizado ou a Dometic.
O mostrador apresenta: P1	Proteção contra subtensão	Contacte um agente de assistência autorizado ou a Dometic.
O mostrador apresenta: P2	Proteção de sobretensão AC da unidade	Contacte um agente de assistência autorizado ou a Dometic.
O mostrador apresenta: P4	Proteção de sobreaquecimento do tubo de descarga	Contacte um agente de assistência autorizado ou a Dometic.
O mostrador apresenta: P5	Proteção da bobina do evaporador (modo de refrigeração)	Contacte um agente de assistência autorizado ou a Dometic.
O mostrador apresenta: P6	Proteção da bobina do condensador (modo de refrigeração)	Contacte um agente de assistência autorizado ou a Dometic.
O mostrador apresenta: P7	Proteção da bobina do evaporador (modo de aquecimento)	Contacte um agente de assistência autorizado ou a Dometic.
O mostrador apresenta: P9	Acionamento do compressor com anomalia ou compressor não arranca	Contacte um agente de assistência autorizado ou a Dometic.
O mostrador apresenta: E0	Falha de comunicação	Contacte um agente de assistência autorizado ou a Dometic.
O mostrador apresenta: E1	Falha do sensor de temperatura ambiente	Contacte um agente de assistência autorizado ou a Dometic.
O mostrador apresenta: E2	Falha do sensor de temperatura da bobina do evaporador	Contacte um agente de assistência autorizado ou a Dometic.
O mostrador apresenta: E3	Falha do sensor de temperatura da bobina do condensador	Contacte um agente de assistência autorizado ou a Dometic.
O mostrador apresenta: E7	Falha do sensor de temperatura exterior	Contacte um agente de assistência autorizado ou a Dometic.
O mostrador apresenta: E8	Falha do sensor de temperatura do tubo de descarga	Contacte um agente de assistência autorizado ou a Dometic.
O mostrador apresenta: E9	Falha do acionamento do compressor ou do módulo IPM	Contacte um agente de assistência autorizado ou a Dometic.
O mostrador apresenta: EA	Falha do sensor de corrente	Contacte um agente de assistência autorizado ou a Dometic.
O mostrador apresenta: EE	Falha do EEPROM exterior	Contacte um agente de assistência autorizado ou a Dometic.

Falha	Possível causa	Sugestão de solução
O mostrador apresenta: EL	Falha de comunicação LIN-BUS/CI-BUS	Contacte um agente de assistência autorizado ou a Dometic.

## 13 Eliminação



Sempre que possível, coloque o material de embalagem no respetivo contentor de reciclagem. Informe-se junto do centro de reciclagem ou revendedor mais próximo sobre como eliminar este produto de acordo com as disposições de eliminação aplicáveis.



Proteja o meio ambiente! Os acumuladores e pilhas não devem ser eliminados juntamente com o lixo doméstico. Entregue os seus acumuladores danificados ou pilhas gastas numa loja ou centro de recolha.

## 14 Garantia

Aplica-se o prazo de garantia legal. Se o produto apresentar defeitos, contacte a filial do fabricante no seu país (ver [dometic.com/dealer](http://dometic.com/dealer)) ou o seu revendedor.

Para fins de reparação ou de garantia, terá de enviar também os seguintes documentos:

- Uma cópia da fatura com a data de aquisição
- Um motivo de reclamação ou uma descrição da falha

Tenha em atenção que as reparações feitas por si ou por não profissionais podem ter consequências sobre a segurança e anular a garantia.

## 15 Dados técnicos

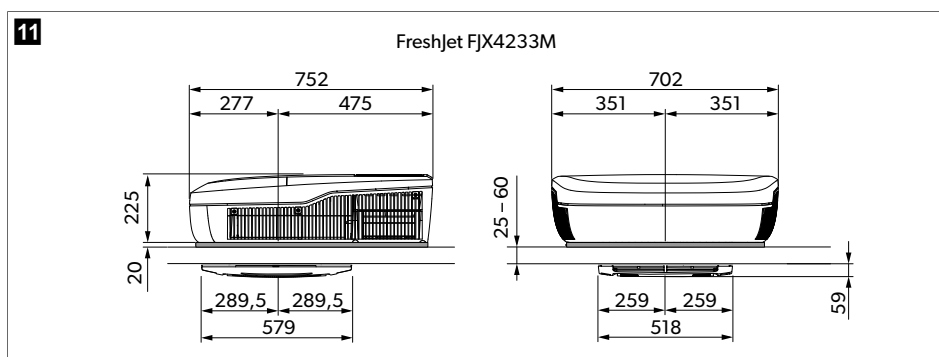



12

FJX4233EEH, FJX4333E(EH), FJX7333IHP

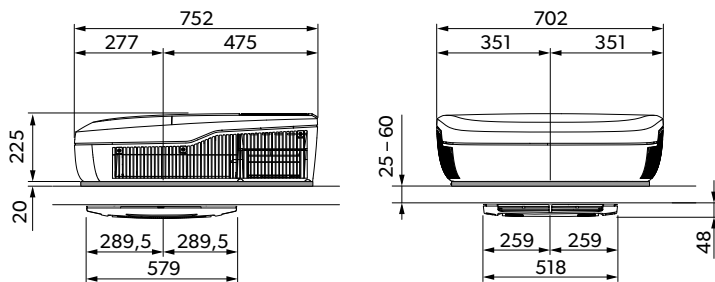

13

FreshJet FJX7337IHP

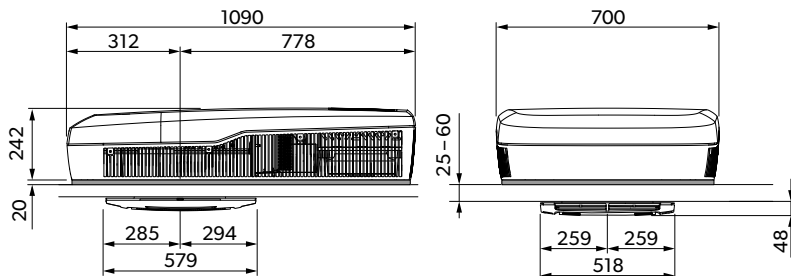

14

FreshJet FJX7457IHP

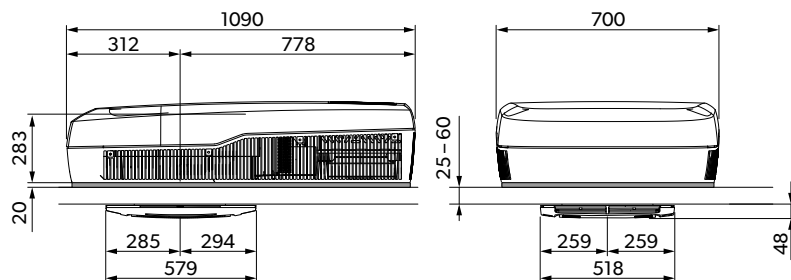

Contém gases fluorados com efeito de estufa. Equipamento hermeticamente selado.

	<b>FreshJet FJX4233M</b>
Potência de refrigeração conforme ISO 5151:	1500 W
Tensão de entrada AC:	220 V ... 240 V / 50 Hz

	<b>FreshJet FJX4233M</b>
Corrente nominal para refrigeração:	< 3.3 A
Fusível necessário:	4 A
Intervalo de temperatura de funcionamento:	- 2 °C ... 52 °C
Agente de refrigeração:	R410a
Quantidade de agente de refrigeração:	380 g
Equivalente a CO <sub>2</sub> :	0.793 t
Potencial de aquecimento global (PAG):	2088
Classe de proteção (unidade de tejadilho):	IPX4
Nível de ruídos (definição máxima do ventilador)	< 70 dB(A)
Comprimento do veículo máx. sugerido (com paredes isoladas):	< 5 m
Dimensões CxLxA:	fig. 11 na página 136
Peso:	< 30 kg
Inspeção/certificação:	

	<b>FreshJet FJX4233EEH</b>	<b>FreshJet FJX4333EEH</b>	<b>FreshJet FJX4333E</b>
Potência de refrigeração conforme ISO 5151:	1700 W	2200 W	2200 W
Potência de aquecimento conforme ISO 5151:	800 W	1000 W	-
Tensão de entrada AC:	220 V ... 240 V / 50 Hz		
Corrente nominal para refrigeração:	3.6 A	4.8 A	4.8 A
Corrente nominal para aquecimento:	< 5.2 A	< 5.2 A	-
Fusível necessário:	4 A	5 A	6 A

	<b>FreshJet FJX4233EEH</b>	<b>FreshJet FJX4333EEH</b>	<b>FreshJet FJX4333E</b>
Intervalo de temperatura de funcionamento:	- 2 °C ... 52 °C		
Agente de refrigeração:	R32		
Quantidade de agente de refrigeração:	320 g	360 g	360 g
Equivalente a CO <sub>2</sub> :	0.216 t	0.243 t	0.243 t
Potencial de aquecimento global (PAG):	675		
Classe de proteção (unidade de tejadilho):	IPX4		
Nível de ruídos (definição máxima do ventilador)	< 70 dB(A)		
Comprimento do veículo máx. sugerido (com paredes isoladas):	< 6 m	< 7 m	< 7 m
Dimensões CxLxA:	fig. 12 na página 137		
Peso:	< 30 kg	< 30 kg	< 30 kg
Inspeção/certificação:			

	<b>FreshJet FJX7333IHP</b>	<b>FreshJet FJX7337IHP</b>	<b>FreshJet FJX7457IHP</b>
Potência de refrigeração conforme ISO 5151:	2200 W	3000 W	3500 W
Potência de aquecimento conforme ISO 5151:	2000 W	2500 W	3000 W
Tensão de entrada AC:	220 V ... 240 V / 50 Hz ... 60 Hz	220 V ... 240 V / 50 Hz ... 60 Hz	220 V ... 240 V / 50 Hz ... 60 Hz
Corrente nominal para refrigeração:	< 7.5 A	< 7.5 A	< 7.5 A
Corrente nominal para aquecimento:	< 6.1 A	< 6.1 A	< 6.1 A
Fusível necessário:	6 A	6 A	6 A
Intervalo de temperatura de funcionamento:	- 2 °C ... 52 °C	- 2 °C ... 52 °C	- 2 °C ... 52 °C
Agente de refrigeração:	R32	R32	R32

	<b>FreshJet FJX7333IHP</b>	<b>FreshJet FJX7337IHP</b>	<b>FreshJet FJX7457IHP</b>
Quantidade de agente de refrigeração:	420 g	480 g	650 g
Equivalente a CO <sub>2</sub> :	0.2835 t	0.3240 t	0.43875 t
Potencial de aquecimento global (PAG):	675		
Classe de proteção (unidade de tejadilho):	IPX4		
Nível de ruídos (definição máxima do ventilador)	< 70 dB(A)		
Comprimento do veículo máx. sugerido (com paredes isoladas):	< 7 m	< 7 m	> 8 m
Dimensões CxLxA:	fig. 12 na página 137	fig. 13 na página 137	fig. 14 na página 137
Peso:	< 30 kg	< 35 kg	< 40 kg
Inspeção/certificação:			

## Italian

1	Important notes.....	141
2	Spiegazione dei simboli.....	141
3	Istruzioni per la sicurezza.....	142
4	Destinazione d'uso.....	143
5	Spiegazioni dei simboli sull'apparecchio.....	144
6	Limiti tecnici e condizioni.....	144
7	Descrizione delle caratteristiche tecniche.....	144
8	Prima della messa in funzione iniziale.....	150
9	Funzionamento.....	150
10	Pulizia del climatizzatore a tetto.....	158
11	Manutenzione.....	158
12	Risoluzione dei problemi.....	160
13	Smaltimento.....	163
14	Garanzia.....	163
15	Specifiche tecniche.....	163

## 1 Important notes

Si prega di leggere attentamente e di seguire tutte le istruzioni, le linee guida e le avvertenze incluse in questo manuale del prodotto, al fine di garantire che il prodotto venga sempre installato, utilizzato e mantenuto nel modo corretto. Queste istruzioni DEVONO essere conservate insieme al prodotto.

Utilizzando il prodotto, l'utente conferma di aver letto attentamente tutte le istruzioni, le linee guida e le avvertenze e di aver compreso e accettato di rispettare i termini e le condizioni qui espressamente indicati. L'utente accetta di utilizzare questo prodotto solo per lo scopo e l'applicazione previsti e in conformità con le istruzioni, le linee guida e le avvertenze indicate nel presente manuale del prodotto, nonché in conformità con tutte le leggi e i regolamenti applicabili. La mancata lettura e osservanza delle istruzioni e delle avvertenze qui espressamente indicate può causare lesioni personali e a terzi, danni al prodotto o ad altre proprietà nelle vicinanze. Il presente manuale del prodotto, comprese le istruzioni, le linee guida e le avvertenze e la relativa documentazione possono essere soggetti a modifiche e aggiornamenti. Per informazioni aggiornate sul prodotto, visitare [documents.dometic.com](https://documents.dometic.com).

## 2 Spiegazione dei simboli



**PERICOLO!** indica una situazione di pericolo che, se non evitata, provoca lesioni gravi o mortali.



**AVVERTENZA!** indica una situazione di pericolo che, se non evitata, provoca lesioni gravi o mortali.



**ATTENZIONE!** indica una situazione di pericolo che, se non evitata, potrebbe provocare lesioni di entità lieve o moderata.



**AVVISO!** indica una situazione di pericolo che, se non evitata, potrebbe provocare lesioni di entità lieve o moderata.



**Nota** Informazioni integranti relative all'impiego del prodotto.

### 3 Istruzioni per la sicurezza



**AVVERTENZA! La mancata osservanza di queste avvertenze potrebbe causare la morte o lesioni gravi.**

- **Gli apparecchi elettrici non sono giocattoli.** L'apparecchio non deve essere utilizzato da persone (compresi i bambini) con ridotte capacità fisiche, sensoriali o mentali, o prive di esperienza e di conoscenze specifiche, a meno che non siano sorvegliate o siano state istruite sull'uso dell'apparecchio da una persona responsabile della loro sicurezza.
- Controllare che i bambini non giochino con l'apparecchio.
- Questo apparecchio può essere utilizzato da bambini di età superiore a 8 anni, da persone con capacità fisiche, sensoriali o mentali ridotte o da persone prive di esperienza e di conoscenze specifiche solo se supervisionati o istruiti sull'uso sicuro dell'apparecchio e dopo aver compreso i rischi correlati.
- La pulizia non deve essere eseguita da bambini senza supervisione.
- Chiunque sia coinvolto in interventi su un circuito di raffreddamento deve essere in possesso di un certificato valido rilasciato da un'autorità di valutazione accreditata del settore che confermi la sua capacità di maneggiare i refrigeranti in modo sicuro, in conformità alle specifiche di valutazione riconosciute dal settore.
- La manutenzione deve essere eseguita solo secondo quanto raccomandato dal produttore dell'apparecchiatura. Gli interventi di manutenzione e riparazione che richiedono l'assistenza di altro personale qualificato devono essere eseguiti sotto la supervisione di una persona competente nell'uso di refrigeranti infiammabili.
- Le riparazioni dell'apparecchio devono essere eseguite solo da personale qualificato che abbia familiarità con i rischi e con le norme vigenti in materia. Le riparazioni effettuate in modo scorretto possono causare gravi pericoli. Per il servizio di riparazione, contattare il centro di assistenza del proprio Paese ([vedere dometic.com/dealer](http://dometic.com/dealer)).
- Interrompere sempre l'alimentazione elettrica quando si lavora sull'apparecchio.
- L'apparecchio deve essere conservato in un ambiente privo di fonti di accensione continuamente in funzione (ad esempio: fiamme libere, apparecchiature a gas o riscaldatori elettrici in funzione).
- Non forare o bruciare l'apparecchio.
- Tenere presente che i refrigeranti possono essere inodori.
- Non utilizzare l'apparecchio nelle vicinanze di liquidi infiammabili oppure in locali chiusi.
- Assicurarsi che nella zona delle bocchette dell'aria non siano collocati o montati oggetti infiammabili. Deve essere rispettata una distanza minima di 50 cm.
- Tenere le aperture di ventilazione libere da ostruzioni.
- Non danneggiare il circuito di raffreddamento.
- In nessun caso devono essere utilizzate potenziali fonti di accensione per la ricerca o il rilevamento di perdite di refrigerante. Non utilizzare una torcia ad alogenuri (o qualsiasi altro rilevatore che utilizzi una fiamma libera).
- Il climatizzatore deve essere installato su un veicolo con un'area del pavimento superiore a 4 m<sup>2</sup>.



**ATTENZIONE! La mancata osservanza di queste precauzioni potrebbe causare lesioni lievi o moderate.**

- Non toccare l'interno delle bocchette di aerazione e non introdurre nessun corpo estraneo nell'apparecchio.
- In caso d'incendio non rimuovere il coperchio superiore dell'apparecchio. Utilizzare invece agenti estinguenti approvati. Non tentare di estinguere l'incendio con acqua.
- Se il cavo di collegamento viene danneggiato, deve essere sostituito dal fabbricante, dal suo servizio di assistenza clienti o da personale ugualmente qualificato al fine di evitare pericoli.
- Nel caso in cui l'apparecchio contenga uno ionizzatore, chi presenta condizioni mediche dovrebbe consultare un medico. Lo ionizzatore può produrre ozono (O<sub>3</sub>) in piccole quantità. Se si soffre di malattie polmonari, asma, malattie cardiache, malattie respiratorie, problemi respiratori, oppure si è sensibili all'ozono, consultare il proprio medico per determinare se l'uso di questo apparecchio è sicuro per le proprie condizioni.



**AVVISO! Rischio di danni**

- Non utilizzare mezzi per accelerare il processo di sbrinamento o per la pulizia diversi da quelli raccomandati dal produttore.
- L'apparecchio deve essere conservato in modo da evitare danni meccanici.
- Non eseguire modifiche o trasformazioni all'apparecchio!
- Non utilizzare mai autolavaggi automatici quando l'apparecchio è montato.
- Se si verificano guasti nel circuito di raffreddamento, l'apparecchio deve essere controllato e riparato dal fabbricante, dal suo servizio di assistenza clienti o da personale qualificato al fine di evitare pericoli.

## 4 Destinazione d'uso

Il climatizzatore FreshJet FJX è progettato solo per l'installazione sul tetto di un caravan o di un veicolo ricreazionale per fornire il raffreddamento.

Il climatizzatore **non** è adatto per treni, case e appartamenti. Il climatizzatore **non** è adatto per essere montato su macchine edili, macchine agricole o macchine da lavoro simili.

Questo prodotto è adatto solo per l'uso e l'applicazione previsti in conformità con le presenti istruzioni.

Il presente manuale fornisce le informazioni necessarie per la corretta installazione e/o il funzionamento del prodotto. Un'installazione errata e/o un utilizzo o una manutenzione impropri comporteranno prestazioni insoddisfacenti e un possibile guasto.

Il produttore non si assume alcuna responsabilità per eventuali lesioni o danni al prodotto che derivino da:

- montaggio o collegamento non corretti, compresa la sovratensione
- manutenzione non corretta o uso di ricambi diversi da quelli originali forniti dal produttore
- modifiche al prodotto senza esplicita autorizzazione del produttore
- impiego per scopi diversi da quelli descritti nel presente manuale.

Dometic si riserva il diritto di modificare l'aspetto e le specifiche del prodotto.

## 5 Spiegazioni dei simboli sull'apparecchio



Avviso! Materiale a velocità di combustione lenta.



Leggere le istruzioni per l'uso.



Leggere il manuale di manutenzione.

## 6 Limiti tecnici e condizioni

Il climatizzatore è destinato ai veicoli con tetto con uno spessore di 25 mm ... 60 mm. Il funzionamento del climatizzatore è garantito per temperature ambiente comprese tra  $-2^{\circ}\text{C}$  ...  $52^{\circ}\text{C}$ . Il climatizzatore è progettato per essere installato entro  $\pm 10^{\circ}$  dal piano orizzontale. Le prestazioni del climatizzatore possono essere ridotte quando è esposto a forti vibrazioni, provocate ad esempio da strade dissestate.

## 7 Descrizione delle caratteristiche tecniche

Il climatizzatore FreshJet FJX4233M fornisce all'abitacolo del veicolo aria fresca, priva di polvere e sporcizia, che può essere deumidificata.

Il climatizzatore FreshJet FJX4233EEH/FJX4333E(EH)/FJX7333IHP/FJX7337IHP/FJX7457IHP fornisce all'abitacolo del veicolo aria fresca o calda, priva di polvere e sporcizia, che può essere deumidificata.

Il climatizzatore può abbassare la temperatura all'interno del veicolo a un determinato livello, a seconda del tipo di veicolo, della temperatura ambiente e della capacità di raffreddamento del climatizzatore. A temperature esterne inferiori a  $16^{\circ}\text{C}$  il climatizzatore non raffredda più.

Il climatizzatore viene fatto funzionare con i seguenti elementi di comando:

- Pannello di controllo

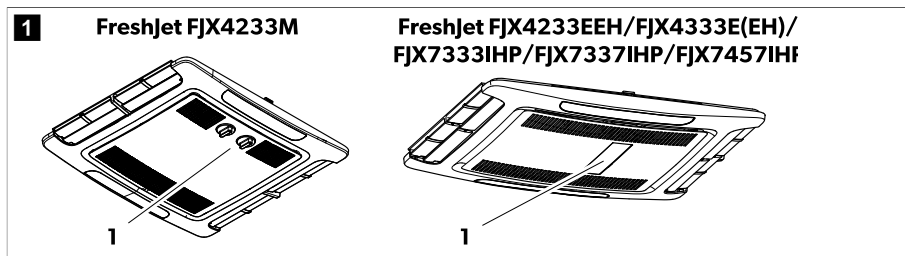

- Telecomando (solo FJX4233EEH/FJX4333E(EH)/FJX7333IHP/FJX7337IHP/FJX7457IHP)



## 7.1 Elenco dei modelli

La tabella seguente mostra le funzioni dei vari modelli:

● Funzione disponibile

○ Funzione disponibile con upgrade

	FJX4233M	FJX4233EEH	FJX4333EEH	FJX4333E	FJX7333IHP	FJX7337IHP	FJX7457IHP
Automatica		●	●	●	●	●	●
Raffreddamento	●	●	●	●	●	●	●
Riscaldamento		●	●	○	●	●	●
Ventilazione	●	●	●	●	●	●	●
Deumidificazione		●	●	●	●	●	●
Purificatore d'aria	○	●	●	○	●	●	●
Luce a ADB		●	●	○	●	●	●
Luce esterna					●	●	●
Timer		●	●	●	●	●	●
Sleep		●	●	●	●	●	●
soft start			●	○	●	●	●

## 7.2 Pannello di controllo FreshJet FJX4233M

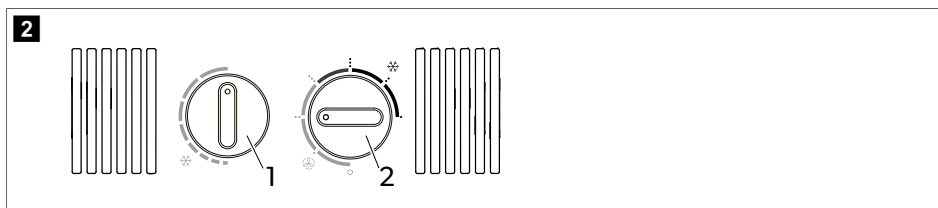

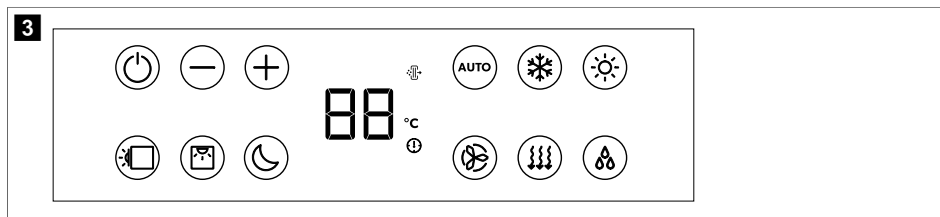

Manopola	Descrizione
	Seleziona la temperatura. Ruotare in senso orario per un raffreddamento più elevato.
	Attiva o disattiva il climatizzatore e seleziona l'intensità della circolazione dell'aria in modalità di ventilazione (🌀) o l'intensità di raffreddamento in modalità di raffreddamento (❄️).

### 7.3 Pannello di controllo FreshJet FJX4233EEH/FJX4333E(EH)/FJX7333IHP/ FJX7337IHP/FJX7457IHP



















Simbolo	Descrizione
	Accende il climatizzatore o lo commuta in modo stand-by.
	aumenta il valore attualmente visualizzato.
	diminuisce il valore attualmente visualizzato.
	Esegue l'accoppiamento con Bluetooth/WLAN quando i due tasti vengono premuti contemporaneamente.
	Accende o spegne le luci ambiente dell'unità a tetto.
	Accende o spegne le luci ambiente nella scatola di distribuzione dell'aria.
	Attiva la funzione Sleep (Funzioni aggiuntive (solo FJX4233EEH/FJX4333E(EH)/FJX7333IHP/FJX7337IHP/ FJX7457IHP) alla pagina 149).
	Visualizza la temperatura impostata e indica il livello della ventola quando quest'ultima è regolata.
	Indica che la modalità AirPurifier è attiva.
	Indica che la temperatura è visualizzata in gradi Celsius.
	Indica che il timer è impostato.
	Attiva/disattiva la modalità automatica (Modalità di climatizzazione (solo FJX4233EEH/FJX4333E(E- H)/FJX7333IHP/FJX7337IHP/FJX7457IHP) alla pagina 149).
	Attiva/disattiva la modalità di raffreddamento (Modalità di climatizzazione (solo FJX4233EEH/FJX4333E(E- H)/FJX7333IHP/FJX7337IHP/FJX7457IHP) alla pagina 149).
	Attiva/disattiva la modalità di riscaldamento (Modalità di climatizzazione (solo FJX4233EEH/FJX4333E(E- H)/FJX7333IHP/FJX7337IHP/FJX7457IHP) alla pagina 149).
	Regola la velocità della ventola tra Bassa, Media, Alta, Turbo o Auto (mostrando 1, 2, 3, 4 o AA sul display del- la scatola di distribuzione dell'aria per un breve periodo di tempo durante il cambio di velocità).

Simbolo	Descrizione
	Attiva/disattiva la modalità di ventilazione (Modalità di climatizzazione (solo FJX4233EEH/FJX4333E(E-H)/FJX7333IHP/FJX7337IHP/FJX7457IHP) alla pagina 149). Fa circolare l'aria con riscaldamento o raffreddamento disattivati.
	Attiva/disattiva la modalità di deumidificazione (Modalità di climatizzazione (solo FJX4233EEH/FJX4333E(E-H)/FJX7333IHP/FJX7337IHP/FJX7457IHP) alla pagina 149).

## 7.4 Telecomando FreshJet FJX4233EEH/FJX4333E(EH)/FJX7333IHP/FJX7337IHP/FJX7457IHP





Elementi di comando e indicazione fig. **4** alla pagina 147:

Pulsante	Descrizione
—	<p><b>Display</b></p> <p>Visualizzazione delle seguenti informazioni:</p> <ul style="list-style-type: none"> <li>• Ora</li> <li>• Temperatura ambiente selezionata (valore target) in °C</li> <li>• Temperatura ambiente reale</li> <li>• Modalità di condizionamento</li> <li>• Velocità di aerazione</li> <li>• Simboli per funzioni aggiuntive attive</li> <li>• Stato della batteria</li> </ul>
	Accende il climatizzatore a tetto o lo commuta in modalità stand-by.
	aumenta il valore attualmente visualizzato.
	diminuisce il valore attualmente visualizzato.
	Seleziona la velocità della ventola (Selezione manuale della velocità della ventola alla pagina 153).
	Seleziona la modalità di condizionamento (Modalità di climatizzazione (solo FJX4233EEH/FJX4333E(E-H)/FJX7333IHP/FJX7337IHP/FJX7457IHP) alla pagina 149). Viene visualizzato il simbolo corrispondente.
	Attiva la funzione Sleep (Funzioni aggiuntive (solo FJX4233EEH/FJX4333E(EH)/FJX7333IHP/FJX7337IHP/FJX7457IHP) alla pagina 149). È visualizzato il simbolo  .
	Conferma e salva le impostazioni.
	Imposta il timer e l'orologio.
	Accende o spegne le luci ambiente nella scatola di distribuzione dell'aria.
	Premere una volta per visualizzare la temperatura interna corrente. È visualizzato il simbolo  .
	Premere due volte per visualizzare la temperatura impostata.
	Attiva la funzione "I feel". È visualizzato il simbolo  .
	Ogni 10 min la funzione "I feel" regola la temperatura obiettivo in base alla temperatura effettiva misurata dal telecomando.
	Accende o spegne le luci ambiente dell'unità a tetto.
	Indica che le batterie del telecomando sono scariche. Sostituire le batterie (Sostituzione delle batterie del telecomando alla pagina 156).
	Indica che il telecomando sta trasmettendo i valori al climatizzatore.





## 7.5 Modalità di climatizzatore (solo FJX4233M)

Il climatizzatore a tetto presenta le seguenti modalità di condizionamento:

Modalità di condizionamento	Simbolo sul display	Descrizione
Raffreddamento		Si stabiliscono le impostazioni della temperatura e della ventola e il climatizzatore raffredda l'abitacolo a questa temperatura.
Ventilazione		Si imposta il livello della ventola e il climatizzatore fa circolare l'aria senza riscaldamento o raffreddamento.





## 7.6 Modalità di climatizzazione (solo FJX4233EEH/FJX4333E(EH)/FJX7333IHP/FJX7337IHP/FJX7457IHP)

Il climatizzatore a tetto presenta le seguenti modalità di condizionamento:

Modalità di condizionamento	Simbolo sul display	Descrizione
Automatica	<b>A</b>	Si stabilisce la temperatura e il climatizzatore porta la temperatura dell'abitacolo a questa temperatura, attivando il riscaldamento o il raffreddamento e controllando la velocità della ventola.
Raffreddamento		Si stabiliscono le impostazioni della temperatura e della ventola e il climatizzatore raffredda l'abitacolo a questa temperatura.
Riscaldamento		<b>Non FJX4333E:</b> si stabiliscono le impostazioni della temperatura e della ventola e il climatizzatore riscalda l'abitacolo a questa temperatura. La ventola si avvia solo dopo 2 min (alla bassa velocità) e dopo circa 5 min raggiunge la velocità impostata della ventola (dopo che l'evaporatore ha raggiunto la temperatura impostata).
Ventilazione		Si imposta il livello della ventola e il climatizzatore fa circolare l'aria senza riscaldamento o raffreddamento.
Deumidificazione dell'aria		Il climatizzatore elimina l'umidità dall'aria senza riscaldare o raffreddare l'abitacolo, riducendo così l'umidità relativa dell'aria.
Purificatore d'aria		<b>Non FJX4333E:</b> il climatizzatore ionizza l'aria, raccogliendo polvere e particelle, inclusi virus e batteri, dall'aria.

## 7.7 Funzioni aggiuntive (solo FJX4233EEH/FJX4333E(EH)/FJX7333IHP/FJX7337IHP/FJX7457IHP)

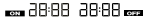
Il climatizzatore a tetto dispone delle seguenti funzioni supplementari:

Funzione supplementare	Messaggi sul display	Descrizione
Timer		Il climatizzatore si accende all'orario impostato.
		Il climatizzatore viene spento all'orario impostato.
		Il climatizzatore viene acceso e spento agli orari impostati.
Sleep		La funzione Sleep abbassa la velocità della ventola e del compressore per ridurre i livelli di rumore e facilitare il sonno.
I Feel		Il telecomando misura la temperatura ambiente e trasmette il valore misurato al climatizzatore ogni 10 min. Il climatizzatore adatta il valore target a questa misurazione.
soft start		<b>Non FJX4233EEH:</b> la corrente di picco prodotta dal compressore viene ridotta dalla funzione Soft Start. Se si utilizza un generatore come alimentazione, il generatore non sarà sovraccaricato.

## 8 Prima della messa in funzione iniziale

### Controlli prima della messa in funzione iniziale

Prima di accendere il climatizzatore, osservare quanto segue:

1. Controllare se la tensione di alimentazione e la frequenza corrispondono ai valori specificati nelle Specifiche tecniche alla pagina 163.
2. Assicurarsi che sia le aperture di aspirazione dell'aria sia le bocchette dell'aria siano libere. Tutte le griglie di ventilazione devono essere sempre mantenute libere per garantire che il climatizzatore a tetto sia in grado di funzionare con la capacità massima.

### Preparazione del telecomando (solo FreshJet FJX4233EEH/FJX4333E(EH)/FJX7333IHP/FJX7337IHP/FJX7457IHP)

3. Inserire le batterie (Sostituzione delle batterie del telecomando alla pagina 156).

### Impostazione dell'ora (solo FreshJet FJX4233EEH/FJX4333E(EH)/FJX7333IHP/FJX7337IHP/FJX7457IHP)

4. Impostare l'ora corrente (Impostazione dell'ora corrente alla pagina 153).

## 9 Funzionamento

### 9.1 Indicazioni per l'uso ottimale

Con le seguenti indicazioni è possibile ottimizzare le prestazioni del climatizzatore:

- Migliorare l'isolamento termico del veicolo chiudendo ermeticamente le fessure e applicando alle finestre tende o tende a rullo riflettenti.
- Selezionare una temperatura e un livello di ventilazione adatti.

- Orientare opportunamente le bocchette dell'aria.
- Assicurarsi che le bocchette dell'aria e le aperture di aspirazione dell'aria non siano ostruite da stoffa, carta o altri oggetti.
- **Solo FreshJet FJX4233EEH/FJX4333E(EH)/FJX7333IHP/FJX7337IHP/FJX7457IHP:** Se il veicolo è stato esposto a lungo alla luce diretta del sole: Far funzionare il climatizzatore in modalità di ventilazione (🌀) con le finestre aperte per un po' di tempo prima di attivare la modalità di raffreddamento (❄️).
- **Solo FreshJet FJX4233EEH/FJX4333E(EH)/FJX7333IHP/FJX7337IHP/FJX7457IHP:** Evitare di aprire porte e finestre il più possibile nella modalità di raffreddamento (❄️).

## 9.2 Indicazioni fondamentali per l'impiego

Il climatizzatore FreshJet FJX4233M dispone di tre modalità di funzionamento:

Modalità di funzionamento	Descrizione
Off	Il climatizzatore a tetto è spento.
Raffreddamento	Il climatizzatore raffredda l'abitacolo.
Ventilazione	Il climatizzatore fa circolare l'aria senza raffreddarla.

Il climatizzatore FreshJet FJX4233EEH/FJX4333E(EH)/FJX7333IHP/FJX7337IHP/FJX7457IHP ha due modalità di funzionamento:

Modalità di funzionamento	Descrizione
Stand-by	Il climatizzatore è pronto per il funzionamento e può essere attivato con il telecomando. Le luci ambiente sono disponibili. Anche il telecomando è in modalità stand-by, ma è possibile accenderlo indipendentemente dal climatizzatore.
On	Il climatizzatore a tetto raffredda l'abitacolo.

## 9.3 Dometic FJX4233M

Le informazioni fornite in questo capitolo si applicano solo ai climatizzatori FJX4233M.

### 9.3.1 Accensione e spegnimento del climatizzatore

Il climatizzatore presenta due modalità di climatizzazione:

- modalità di ventilazione (🌀)
- modalità di raffreddamento (❄️)





**Nota** Prima di passare dalla modalità di ventilazione alla modalità di raffreddamento o viceversa attendere almeno 30 s. Altrimenti la corrente di commutazione può bruciare il fusibile.

Ogni modalità ha tre impostazioni:

- ..: Bassa
- ...: Medio
- ....: Alta

>

Per attivarle, ruotare la manopola  nella posizione della modalità di ventilazione () o in quella della modalità di raffreddamento () e scegliere l'impostazione desiderata.

✓ Il climatizzatore è acceso e funziona con i valori impostati prima di spegnersi.

>

Per disattivarle, ruotare la manopola  nella posizione 0.

### 9.3.2 Regolazione della temperatura

>

Ruotare la manopola  nella posizione desiderata. Ruotando la manopola in senso orario si seleziona una temperatura più bassa.

✓ È impostata la temperatura nel climatizzatore a tetto.

## 9.4 FreshJet FJX4233EEH/FJX4333E(EH)/FJX7333IHP/FJX7337IHP/FJX7457IHP

Le informazioni fornite in questo capitolo si applicano solo ai climatizzatori FreshJet FJX4233EEH/FJX4333E(EH)/FJX7333IHP/FJX7337IHP/FJX7457IHP.

### 9.4.1 Con il controllo remoto

Quando si utilizza il telecomando, prendere in considerazione i seguenti suggerimenti:

- Puntare il telecomando verso il ricevitore IR del pannello di controllo.
  - Le impostazioni e i valori corrispondenti vengono trasmessi direttamente al climatizzatore quando si preme un tasto.
  - Il climatizzatore conferma la ricezione dei dati con un segnale acustico.
  - I valori aumentano o diminuiscono più velocemente tenendo premuti i tasti + o -.
  - In modalità stand-by, anche il display del telecomando è inattivo. È possibile accendere il telecomando in modalità stand-by indipendentemente dal climatizzatore.
- > Per attivare o disattivare la modalità stand-by solo sul telecomando, premere il tasto  senza puntare verso il ricevitore IR del pannello di controllo.

### 9.4.2 Accensione del climatizzatore e passaggio alla modalità stand-by



**Nota** Quando il climatizzatore è acceso, funziona con i valori impostati prima di passare alla modalità stand-by. Il climatizzatore può essere spento solo interrompendo l'alimentazione.

- > Premere il tasto  sul telecomando o il tasto  sul pannello di controllo per accendere il climatizzatore o farlo passare alla modalità stand-by.









### 9.4.3 Selezione della modalità di climatizzazione

- > Selezionare la modalità di climatizzazione desiderata con il tasto MODE (Modalità di climatizzazione (solo FJX4233EEH/FJX4333E(EH)/FJX7333IHP/FJX7337IHP/FJX7457IHP) alla pagina 149).
- ✓ Il climatizzatore conferma la ricezione dei valori con un segnale acustico. Il climatizzatore a tetto passa alla modalità di condizionamento selezionata.



### 9.4.4 Selezione manuale della velocità della ventola

È possibile selezionare manualmente la velocità della ventola in tutte le modalità, ad eccezione della modalità automatica (A) e di deumidificazione (D).

Messaggi sul display	Descrizione
	Livello della ventola basso
	Livello della ventola medio
	Livello della ventola alto.
	Livello della ventola turbo.
	Modalità automatica (la velocità della ventola viene regolata in base alla temperatura ambiente).

- > Premere il tasto  del telecomando o il tasto  del pannello di controllo per selezionare la velocità della ventola desiderata.
- ✓ Il climatizzatore conferma la ricezione dei valori con un segnale acustico.  
È impostata la nuova velocità della ventola.

### 9.4.5 Regolazione della temperatura

Nelle modalità automatica (A), di raffreddamento () di riscaldamento () e di deumidificazione (D) è possibile specificare una temperatura compresa tra 16 °C e 31 °C.

- > Usare il tasto + o - sul telecomando per impostare la temperatura desiderata.
- ✓ Il climatizzatore a tetto conferma la ricezione dei dati con un suono acuto. È impostata la temperatura nel climatizzatore a tetto.

### 9.4.6 Impostazione dell'ora corrente

Per la programmazione del timer nel comando a distanza deve essere impostata l'ora attuale. L'ora è visualizzata sul display del telecomando.

1. Tenere premuto il tasto  per accedere alla modalità di impostazione dell'ora.  
✓ L'ora lampeggia sul display del comando a distanza.
2. Con i tasti + e - impostare l'ora attuale. Tenere premuti i tasti + o - per oltre 2 s regolare l'ora più rapidamente.
3. Per confermare l'ora, premere il tasto SET.















### 9.4.7 Programmazione del timer

Con la funzione Timer è possibile impostare il periodo di tempo desiderato per il condizionamento. È possibile specificare il tempo di accensione, il tempo di passaggio alla modalità stand-by o entrambi i valori.

La funzione del timer viene impostata tramite il telecomando.



**Nota** Se durante la programmazione del timer sul telecomando non viene premuto alcun tasto per 15 s, il telecomando torna alla modalità iniziale.







- > Impostare il **timer di accensione** come segue:
  - a) Selezionare la modalità di climatizzazione desiderata e tutti i valori richiesti (ad esempio la temperatura).
  - b) Se necessario, portare il climatizzatore in modalità stand-by.  
Il timer di accensione può essere impostato solo quando il climatizzatore è in **stand-by**.
  - c) Premere il pulsante  una volta.  
✓ Il simbolo  lampeggia sul display del telecomando.
  - d) Usare il tasto + o – per impostare l'ora in cui il climatizzatore deve accendersi.
  - e) Premere il tasto .  
Il timer di accensione è impostato. Il climatizzatore viene attivato con la modalità selezionata all'ora specificata.
- > Impostare il **timer del passaggio alla modalità stand-by** come segue:
  - a) Se necessario, accendere il climatizzatore.  
Il timer di passaggio alla modalità stand-by può essere impostato solo quando il climatizzatore è **acceso**.
  - b) Premere il tasto  due volte.  
✓ Il simbolo  lampeggia sul display del telecomando.
  - c) Usare i tasti + o – per impostare l'ora in cui il climatizzatore deve passare alla modalità stand-by.
  - d) Premere il tasto .  
Il timer del passaggio alla modalità stand-by è impostato. Il climatizzatore passerà alla modalità stand-by all'ora indicata.
- > Impostare il **timer di accensione** e il **timer di passaggio alla modalità stand-by** come segue:
  - a) Selezionare la modalità di climatizzazione desiderata e tutti i valori richiesti (ad esempio la temperatura).
  - b) Premere il tasto  tre volte.  
✓ Sul display del telecomando viene visualizzato il simbolo  . Il simbolo ON lampeggia.
  - c) Usare il tasto + o – per impostare l'ora in cui il climatizzatore deve accendersi.
  - d) Premere il tasto .  
✓ Il simbolo **OFF** lampeggia.
  - e) Usare i tasti + o – per impostare l'ora in cui il climatizzatore deve passare alla modalità stand-by.
  - f) Premere il tasto .  
✓ Gli orari di accensione e di passaggio alla modalità stand-by sono impostati. Il climatizzatore si accenderà per il periodo di tempo specificato.
- > Per **annullare** il timer preimpostato, premere il tasto  una volta.
- ✓ I simboli   scompaiono. I valori preimpostati vengono eliminati.

### 9.4.8 Impostazione della funzione Sleep

La funzione Sleep è disponibile solo nelle modalità di raffreddamento (❄️) o riscaldamento (☀️).

La funzione Sleep limita la velocità della ventola a un livello più basso per ridurre i livelli di rumore e facilitare il sonno.

**Solo FJX7333IHP/FJX7337IHP/FJX7457IHP:** La funzione Sleep limita inoltre la velocità del compressore.

- > Per attivare la funzione Sleep procedere come segue:
  - a) Impostare la temperatura richiesta (Regolazione della temperatura alla pagina 153).
  - b) Premere il tasto  sul telecomando o il tasto  sul pannello di controllo.
- ✓ Sul display del telecomando viene visualizzato il simbolo . La funzione Sleep è attivata.
  - > Per disattivare la funzione Sleep, premere il tasto  o il tasto  sul telecomando o il tasto  sul pannello di controllo.
- ✓ Il simbolo  scompare dal display del telecomando. La funzione Sleep è disattivata.

### 9.4.9 Attivazione della funzione "I feel"

Quando questa funzione è attiva, il telecomando misura la temperatura ambiente e trasmette questa misurazione al climatizzatore ogni 10 minuti. Il climatizzatore adatta il valore target a questa misurazione. La funzione "I feel" è attiva solo quando la temperatura è compresa tra +18 °C e +29 °C.

Non riporre il comando a distanza in un luogo che sia molto più caldo o molto più freddo rispetto alla temperatura ambiente media. Ad esempio, non lasciarlo al sole o davanti al climatizzatore.

Quando la temperatura supera +29 °C o scende al di sotto di +18 °C, la funzione "I feel" viene disattivata. Il simbolo  lampeggia tre volte sul display, quindi si spegne.

1. Premere il tasto.
- ✓ La funzione "I feel" è attivata.

Sul display appare il simbolo .

2. Posizionare il telecomando in modo tale che sia orientato verso il ricevitore IR del pannello di controllo. Altrimenti i valori non possono essere trasmessi al climatizzatore.



### 9.4.10 Funzionamento delle luci ambiente







**AVVERTENZA! Rischio di lesioni** Per legge è vietato utilizzare le luci esterne durante la guida del veicolo.

Il tasto  sul telecomando è attivo anche se il telecomando è spento.

**Solo FreshJet FJX4233EEH/FJX4333E(EH)/FJX7333IHP/FJX7337IHP/FJX7457IHP:**

- > Per accendere o spegnere le luci interne, premere il tasto  sul telecomando o nel pannello di controllo.
- ✓ Quando si accendono le luci interne, sul display del telecomando lampeggia una volta il simbolo .

- > Per regolare l'intensità delle luci interne, procedere come segue:
  - a) Premere il tasto  sul telecomando o sul pannello di controllo per 3 s.
  - b) Quando si preme il tasto  sul telecomando: Premere il tasto  per regolare l'intensità della luce interna tra 50 % e 100 %.
  - c) Quando si preme il tasto  sul pannello di controllo: La luminosità della luce interna cambia tra 50 % e 100 %.  
Una volta raggiunta la luminosità desiderata, rilasciare il tasto .

#### Solo FreshJet FJX7333IHP/FJX7337IHP/FJX7457IHP:

- > Per accendere o spegnere le luci esterne, premere il tasto  sul pannello di controllo.

### 9.4.11 Sostituzione delle batterie del telecomando



**Nota** Il display del telecomando può essere ancora illuminato anche se le batterie sono in esaurimento. Sostituire le batterie quando il telecomando indica che le batterie sono scariche.

- > Sostituire le batterie come illustrato.

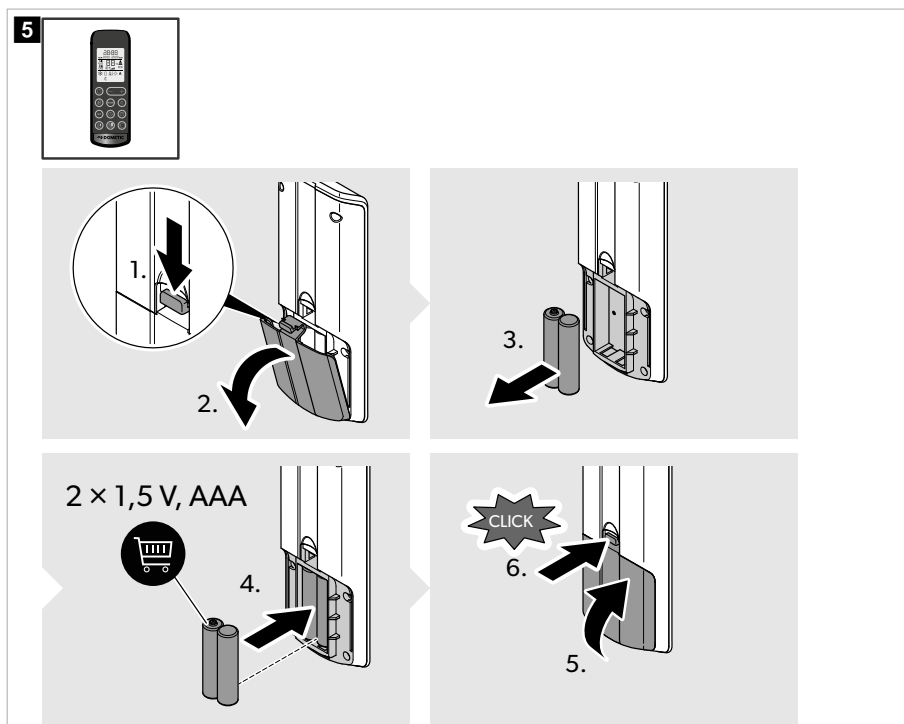

- ✓ Il display mostra tutti i simboli per 5 s.



Proteggete l'ambiente! Gli accumulatori e le batterie non devono essere raccolti insieme ai rifiuti domestici. Consegnare gli accumulatori difettosi o le batterie usate al rivenditore o presso un centro di raccolta.

## 9.5 Regolazione dell'alimentazione dell'aria all'interno del veicolo

Il flusso d'aria può essere regolato lungo il soffitto o verso il pavimento.

- > Orientare le lamelle delle bocchette dell'aria individualmente nelle direzioni richieste.

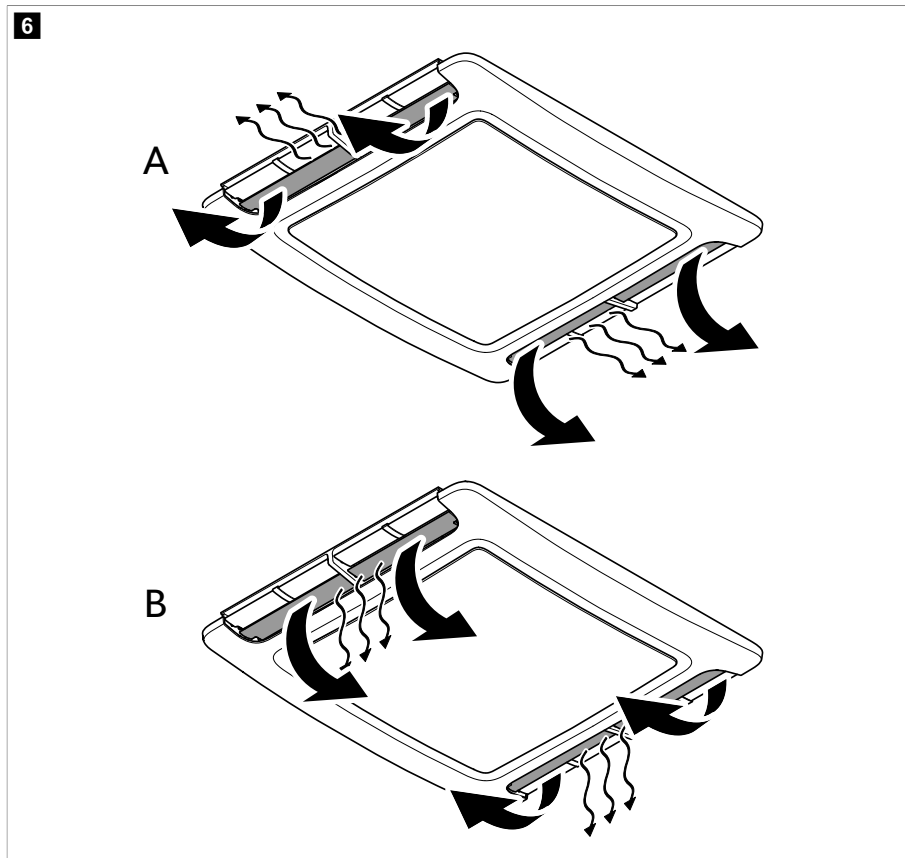

## 10 Pulizia del climatizzatore a tetto



### AVVISO! Rischio di danni

- Non utilizzare mezzi per accelerare il processo di sbrinamento o per la pulizia diversi da quelli raccomandati dal produttore.
- Non pulire il climatizzatore a tetto con un'idropulitrice. Le infiltrazioni di acqua possono danneggiare l'impianto di climatizzazione a tetto.
- Per la pulizia non utilizzare oggetti appuntiti, duri o detersivi abrasivi, dal momento che questi potrebbero danneggiare il climatizzatore a tetto.
- Non utilizzare benzina, gasolio o solventi.

1. Rimuovere regolarmente le foglie e la sporcizia dalle aperture di aspirazione dell'aria e dalle griglie di ventilazione del climatizzatore. Non danneggiare le griglie di ventilazione durante l'operazione.

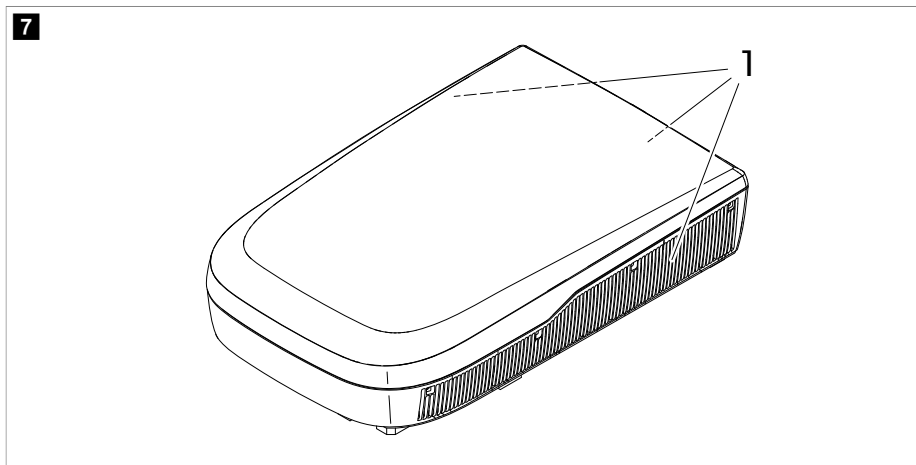

2. Di tanto in tanto, pulire l'unità a tetto e la scatola di distribuzione dell'aria con un panno umido. Utilizzare solo acqua con un detersivo delicato.
3. **Solo FreshJet FJX4233EEH/FJX4333E(EH)/FJX7333IHP/FJX7337IHP/FJX7457IHP:** di tanto in tanto, pulire il telecomando con un panno leggermente umido. Pulire il display con un panno per la pulizia degli occhiali.
4. **Solo FreshJet FJX4233EEH/FJX4333E(EH)/FJX7333IHP/FJX7337IHP/FJX7457IHP:** di tanto in tanto, pulire il display della scatola di distribuzione dell'aria con acqua leggermente saponata. Lo schermo del display è acrilico e può essere danneggiato da alcune sostanze chimiche comuni per la casa, quali detersivi chimici, detersivi per vetri, alcol, alcuni tensioattivi, solventi organici e ammorbidenti.

## 11 Manutenzione

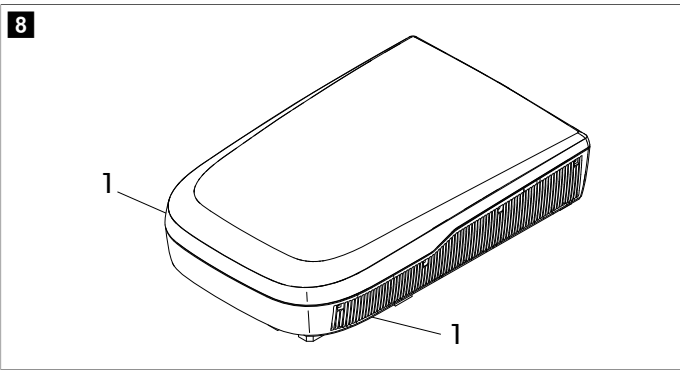
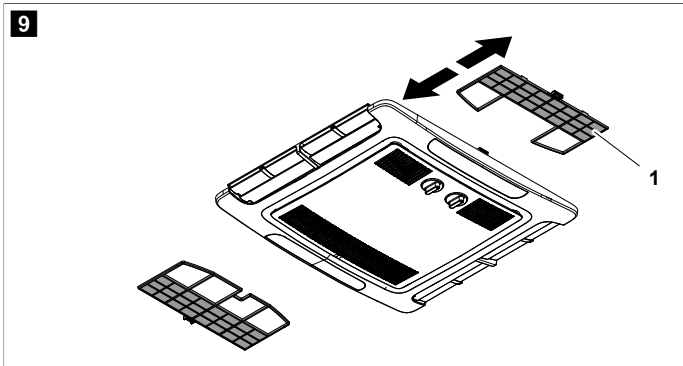

**AVVERTENZA! Rischio di lesioni** I lavori di manutenzione in aggiunta a quelli qui descritti devono essere effettuati solo da personale qualificato informato sui pericoli connessi all'uso del refrigerante e dei condizionatori e sulle relative prescrizioni.

Intervallo	Controllo/manutenzione
Regolare	<p data-bbox="333 188 981 229">Controllare se i canali di scarico dell'acqua di condensa (1) ai lati del climatizzatore a tetto sono liberi e l'acqua di condensa può fuoriuscire.</p> <div data-bbox="333 245 1016 616"><p data-bbox="344 252 367 284"><b>8</b></p></div>
Regolare (Freshjet FJX4233M)	<p data-bbox="333 643 633 663">Pulire il filtro dell'unità di scarico dell'aria.</p> <div data-bbox="333 679 1016 1046"><p data-bbox="344 686 367 718"><b>9</b></p></div> <ol data-bbox="348 1062 857 1126" style="list-style-type: none"><li>1. Rimuovere il filtro (1).</li><li>2. Pulire il filtro (1) con una soluzione detergente e lasciarlo asciugare.</li><li>3. Reinsere il filtro asciutto (1).</li></ol>

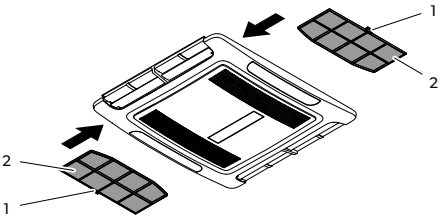
Intervallo	Controllo/manutenzione
Regolare (FreshJet FJX4233EEH/FJX4333E(E- H)/FJX7333IHP/ FJX7337IHP/FJX7457IHP)	<ul style="list-style-type: none"> <li>Pulire il filtro dell'unità di scarico dell'aria.</li> </ul> <div data-bbox="367 225 1016 528" style="border: 1px solid black; padding: 10px; margin: 10px 0;"> <p><b>10</b></p>  </div> <ol style="list-style-type: none"> <li>Inserire un cacciavite piatto o un coltello nella maniglia (1) per estrarre di poco i filtri (2).</li> <li>Rimuovere i filtri a mano.</li> <li>Pulire i filtri con una soluzione detergente e lasciarli asciugare.</li> <li>Reinserire i filtri asciutti, fig. 10 alla pagina 160</li> </ol> <ul style="list-style-type: none"> <li>Fare eseguire la manutenzione dello scambiatore di calore del climatizzatore da un'azienda specializzata.</li> </ul>
Una volta all'anno	<ul style="list-style-type: none"> <li>Controllare se le guarnizioni montate fra il climatizzatore e il tetto del veicolo presentano crepe o altri danni.</li> <li>Controllare che i bulloni di fissaggio siano serrati alla coppia corretta (2,5 Nm ± 0,3 Nm) e, se necessario, regolarli.</li> </ul>

## 12 Risoluzione dei problemi

Guasto	Possibile causa	Rimedio
L'impianto non raffredda bene	Il climatizzatore a tetto non è impostato sulla modalità di raffreddamento.	Impostare il climatizzatore a tetto sulla modalità di raffreddamento.
	La temperatura ambiente è superiore a 52 °C.	Il climatizzatore è progettato solo per temperature ambiente fino a 52 °C.
	La temperatura impostata è superiore alla temperatura ambiente.	Selezionare una temperatura inferiore.
	La temperatura ambiente è inferiore a 16 °C.	Il climatizzatore è progettato per il raffreddamento solo a temperature ambiente superiori a 16 °C.
	Uno dei sensori di temperatura è guasto.	Contattare un tecnico di assistenza autorizzato o Dometic.
	La ventola dell'evaporatore è danneggiata.	Contattare un tecnico di assistenza autorizzato o Dometic.



Guasto	Possibile causa	Rimedio
	La ventola del condensatore è danneggiata.	Contattare un tecnico di assistenza autorizzato o Dometic.
<b>Solo FreshJet FJX4233EEH/ FJX4333E(EH)/FJX7333IHP/ FJX7337IHP/FJX7457IHP:</b> L'impianto non riscalda bene	Il climatizzatore a tetto non è impostato sulla modalità di riscaldamento.	Impostare il climatizzatore a tetto sulla modalità di riscaldamento.
	La temperatura ambiente è inferiore a - 2 °C.	Il climatizzatore è progettato per il raffreddamento solo a temperature ambiente superiori a - 2 °C.
	La temperatura impostata è inferiore alla temperatura ambiente.	Selezionare una temperatura superiore.
	Uno dei sensori di temperatura è guasto.	Contattare un tecnico di assistenza autorizzato o Dometic.
	La ventola dell'evaporatore è danneggiata.	Contattare un tecnico di assistenza autorizzato o Dometic.
Cattiva capacità di aerazione	Le aperture di aspirazione dell'aria sono bloccate od ostruite.	Rimuovere le foglie e lo sporco dalle griglie di ventilazione del climatizzatore a tetto.
	La ventola è guasta.	Contattare un tecnico di assistenza autorizzato o Dometic.
Infiltrazione di acqua nel veicolo.	Le aperture di scarico per l'acqua di condensa sono intasate.	Eliminare l'acqua di condensa dalle aperture di scarico dell'acqua.
	Le guarnizioni sono danneggiate.	Contattare un tecnico di assistenza autorizzato o Dometic.
Il climatizzatore non si accende.	Nessuna alimentazione elettrica collegata.	Controllare l'alimentazione elettrica.
	La tensione è troppo bassa (< 200 V).	Contattare un tecnico di assistenza autorizzato o Dometic.
	Il trasformatore di tensione è guasto.	Contattare un tecnico di assistenza autorizzato o Dometic.
	Uno dei sensori di temperatura è guasto.	Contattare un tecnico di assistenza autorizzato o Dometic.
	Il fusibile elettrico dell'alimentazione elettrica è troppo basso.	Contattare un tecnico di assistenza autorizzato o Dometic.
Il climatizzatore non si spegne.	Uno dei sensori di temperatura è guasto.	Contattare un tecnico di assistenza autorizzato o Dometic.
	Il fusibile elettrico dell'alimentazione elettrica è troppo basso.	Contattare un tecnico di assistenza autorizzato o Dometic.
<b>Solo FreshJet FJX4233EEH/ FJX4333E(EH)/FJX7333IHP/ FJX7337IHP/FJX7457IHP:</b> Il climatizzatore si spegne in continuazione.	Il rilevatore di congelamento è scattato.	La temperatura esterna è troppo bassa o tutte le bocchette dell'aria sono chiuse.

<b>Guasto</b>	<b>Possibile causa</b>	<b>Rimedio</b>
Il display indica: P0	Sovratemperatura o sovracorrente sul modulo IPM	Contattare un tecnico di assistenza autorizzato o Dometic.
Il display indica: P1	Protezione contro le sottotensioni	Contattare un tecnico di assistenza autorizzato o Dometic.
Il display indica: P2	Protezione da sovracorrente CA dell'unità	Contattare un tecnico di assistenza autorizzato o Dometic.
Il display indica: P4	Protezione da surriscaldamento del tubo di scarico	Contattare un tecnico di assistenza autorizzato o Dometic.
Il display indica: P5	Protezione bobina evaporatore (modalità di raffreddamento)	Contattare un tecnico di assistenza autorizzato o Dometic.
Il display indica: P6	Protezione della bobina del condensatore (modalità di raffreddamento)	Contattare un tecnico di assistenza autorizzato o Dometic.
Il display indica: P7	Protezione bobina evaporatore (modalità di riscaldamento)	Contattare un tecnico di assistenza autorizzato o Dometic.
Il display indica: P9	Comando del compressore anomalo o mancato avviamento del compressore	Contattare un tecnico di assistenza autorizzato o Dometic.
Il display indica: E0	Errore di comunicazione	Contattare un tecnico di assistenza autorizzato o Dometic.
Il display indica: E1	Guasto del sensore di temperatura ambiente	Contattare un tecnico di assistenza autorizzato o Dometic.
Il display indica: E2	Guasto del sensore di temperatura della bobina dell'evaporatore	Contattare un tecnico di assistenza autorizzato o Dometic.
Il display indica: E3	Guasto del sensore di temperatura della bobina del condensatore	Contattare un tecnico di assistenza autorizzato o Dometic.
Il display indica: E7	Guasto del sensore di temperatura esterna	Contattare un tecnico di assistenza autorizzato o Dometic.
Il display indica: E8	Guasto del sensore di temperatura del tubo di scarico	Contattare un tecnico di assistenza autorizzato o Dometic.
Il display indica: E9	Guasto del comando del compressore o del modulo IPM	Contattare un tecnico di assistenza autorizzato o Dometic.
Il display indica: EA	Guasto del sensore di corrente	Contattare un tecnico di assistenza autorizzato o Dometic.
Il display indica: EE	Errore EEPROM esterno	Contattare un tecnico di assistenza autorizzato o Dometic.
Il display indica: EL	Errore di comunicazione bus LIN/bus CI	Contattare un tecnico di assistenza autorizzato o Dometic.

## 13 Smaltimento



Raccogliere il materiale di imballaggio possibilmente negli appositi contenitori di riciclaggio. Consultare il centro locale di riciclaggio o il rivenditore specializzato per informazioni su come smaltire il prodotto secondo le norme sullo smaltimento applicabili.



Proteggete l'ambiente! Gli accumulatori e le batterie non devono essere raccolti insieme ai rifiuti domestici. Consegnare gli accumulatori difettosi o le batterie usate al rivenditore o presso un centro di raccolta.

## 14 Garanzia

Vale il termine di garanzia previsto dalla legge. Se il prodotto è difettoso, contattare la filiale del fabbricante nel proprio Paese (vedi [dometic.com/dealer](http://dometic.com/dealer)) o il rivenditore di riferimento.

Per la gestione della riparazione e della garanzia è necessario inviare la seguente documentazione insieme al dispositivo:

- una copia della ricevuta con la data di acquisto,
- il motivo della richiesta o la descrizione del guasto.

Tenere presente che le riparazioni eseguite in autonomia o da personale non professionista possono avere conseguenze sulla sicurezza e invalidare la garanzia.

## 15 Specifiche tecniche

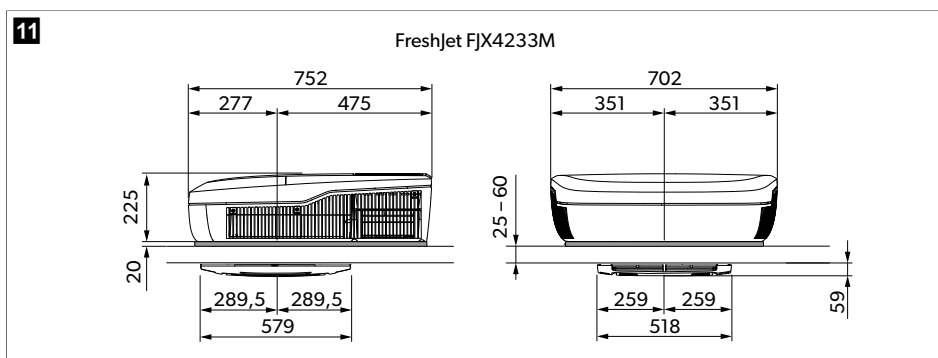

12

FJX4233EEH, FJX4333E(EH), FJX7333IHP

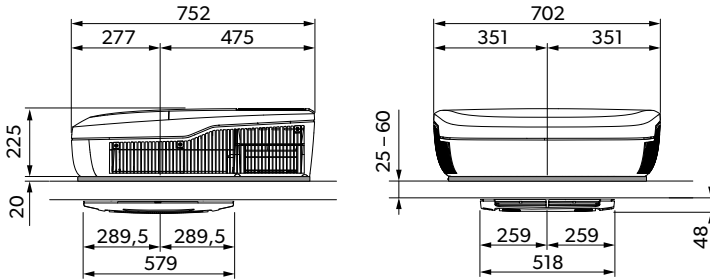

13

FreshJet FJX7337IHP

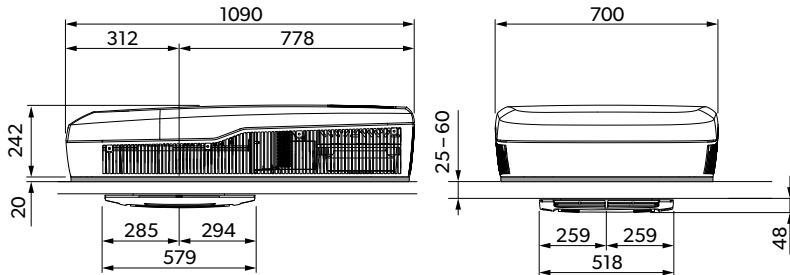

14

FreshJet FJX7457IHP

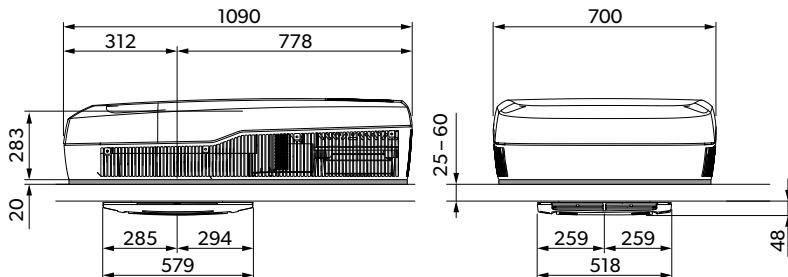

Contiene gas fluorurati ad effetto serra. Apparecchiatura sigillata ermeticamente.

	<b>FreshJet FJX4233M</b>
Capacità di raffreddamento in conformità a ISO 5151:	1500 W
Tensione di ingresso CA:	220 V ... 240 V / 50 Hz

	<b>FreshJet FJX4233M</b>
Raffreddamento a corrente nominale:	< 3.3 A
Fusibile necessario:	4 A
Intervallo temperatura di esercizio:	- 2 °C ... 52 °C
Refrigerante:	R410a
Quantità di refrigerante:	380 g
CO <sub>2</sub> equivalente:	0.793 t
Potenziale di riscaldamento globale (GWP):	2088
Classe di protezione (unità a tetto):	IPX4
Livello di rumorosità (impostazione massima della ventola)	< 70 dB(A)
Lunghezza massima consigliata del veicolo (con pareti isolate):	< 5 m
Dimensioni L x P x A:	fig. <b>11</b> alla pagina 163
Peso:	< 30 kg
Ispezione/certificazione:	

	<b>FreshJet FJX4233EEH</b>	<b>FreshJet FJX4333EEH</b>	<b>FreshJet FJX4333E</b>
Capacità di raffreddamento in conformità a ISO 5151:	1700 W	2200 W	2200 W
Capacità di riscaldamento in conformità a ISO 5151:	800 W	1000 W	-
Tensione di ingresso CA:	220 V ... 240 V / 50 Hz		
Raffreddamento a corrente nominale:	3.6 A	4.8 A	4.8 A
Assorbimento di corrente riscaldamento:	< 5.2 A	< 5.2 A	-
Fusibile necessario:	4 A	5 A	6 A

	<b>FreshJet FJX4233EEH</b>	<b>FreshJet FJX4333EEH</b>	<b>FreshJet FJX4333E</b>
Intervallo temperatura di esercizio:	- 2 °C ... 52 °C		
Refrigerante:	R32		
Quantità di refrigerante:	320 g	360 g	360 g
CO <sub>2</sub> equivalente:	0.216 t	0.243 t	0.243 t
Potenziale di riscaldamento globale (GWP):	675		
Classe di protezione (unità a tetto):	IPX4		
Livello di rumorosità (impostazione massima della ventola)	< 70 dB(A)		
Lunghezza massima consigliata del veicolo (con pareti isolate):	< 6 m	< 7 m	< 7 m
Dimensioni L x P x A:	fig. 12 alla pagina 164		
Peso:	< 30 kg	< 30 kg	< 30 kg
Ispezione/certificazione:			

	<b>FreshJet FJX7333IHP</b>	<b>FreshJet FJX7337IHP</b>	<b>FreshJet FJX7457IHP</b>
Capacità di raffreddamento in conformità a ISO 5151:	2200 W	3000 W	3500 W
Capacità di riscaldamento in conformità a ISO 5151:	2000 W	2500 W	3000 W
Tensione di ingresso CA:	220 V ... 240 V / 50 Hz ... 60 Hz	220 V ... 240 V / 50 Hz ... 60 Hz	220 V ... 240 V / 50 Hz ... 60 Hz
Raffreddamento a corrente nominale:	< 7.5 A	< 7.5 A	< 7.5 A
Assorbimento di corrente riscaldamento:	< 6.1 A	< 6.1 A	< 6.1 A
Fusibile necessario:	6 A	6 A	6 A
Intervallo temperatura di esercizio:	- 2 °C ... 52 °C	- 2 °C ... 52 °C	- 2 °C ... 52 °C
Refrigerante:	R32	R32	R32

	<b>FreshJet FJX7333IHP</b>	<b>FreshJet FJX7337IHP</b>	<b>FreshJet FJX7457IHP</b>
Quantità di refrigerante:	420 g	480 g	650 g
CO <sub>2</sub> equivalente:	0.2835 t	0.3240 t	0.43875 t
Potenziale di riscaldamento globale (GWP):	675		
Classe di protezione (unità a tetto):	IPX4		
Livello di rumorosità (impostazione massima della ventola)	< 70 dB(A)		
Lunghezza massima consigliata del veicolo (con pareti isolate):	< 7 m	< 7 m	> 8 m
Dimensioni L x P x A:	fig. <b>12</b> alla pagina 164	fig. <b>13</b> alla pagina 164	fig. <b>14</b> alla pagina 164
Peso:	< 30 kg	< 35 kg	< 40 kg
Ispezione/certificazione:			

## Dutch

1	Important notes.....	168
2	Verklaring van de symbolen.....	168
3	Veiligheidsaanwijzingen.....	169
4	Beoogd gebruik.....	170
5	Verklaring van de symbolen op het toestel.....	171
6	Technische limieten en voorwaarden.....	171
7	Technische beschrijving.....	171
8	Voor het eerste gebruik.....	177
9	Gebruik.....	177
10	De dakairconditioning reinigen.....	185
11	Onderhoud.....	185
12	Problemen oplossen.....	187
13	Verwijdering.....	190
14	Garantie.....	190
15	Technische gegevens.....	190

## 1 Important notes

Lees deze gebruiksaanwijzing zorgvuldig door en volg alle instructies, richtlijnen en waarschuwingen in deze handleiding op om ervoor te zorgen dat u het product te allen tijde op de juiste manier installeert, gebruikt en onderhoudt. Deze gebruiksaanwijzing MOET bij dit product worden bewaard.

Door het product te gebruiken, bevestigt u hierbij dat u alle instructies, richtlijnen en waarschuwingen zorgvuldig hebt gelezen en dat u de voorwaarden zoals hierin beschreven begrijpt en accepteert. U gaat ermee akkoord dit product alleen te gebruiken voor het beoogde doel en de beoogde toepassing en in overeenstemming met de instructies, richtlijnen en waarschuwingen zoals beschreven in deze gebruiksaanwijzing en in overeenstemming met de geldende wet- en regelgeving. Het niet lezen en opvolgen van de hierin beschreven instructies en waarschuwingen kan leiden tot letsel voor uzelf en anderen, schade aan uw product of schade aan andere eigendommen in de omgeving. Deze gebruiksaanwijzing, met inbegrip van de instructies, richtlijnen en waarschuwingen, en de bijbehorende documentatie kan onderhevig zijn aan wijzigingen en updates. Actuele productinformatie vindt u op [documents.dometic.com](http://documents.dometic.com).

## 2 Verklaring van de symbolen



**GEVAAR!** duidt op een gevaarlijke situatie die, indien deze niet wordt voorkomen, leidt tot ernstig letsel of de dood.



**WAARSCHUWING!** duidt op een gevaarlijke situatie die, indien deze niet wordt voorkomen, leidt tot ernstig letsel of de dood.



**VOORZICHTIG!** duidt op een gevaarlijke situatie die, indien deze niet wordt voorkomen, kan leiden tot licht of matig letsel.





**LET OP!** duidt op een gevaarlijke situatie die, indien deze niet wordt voorkomen, kan leiden tot licht of matig letsel.



**Instructie** Aanvullende informatie voor het gebruik van het product.

### 3 Veiligheidsaanwijzingen



**WAARSCHUWING! Het niet in acht nemen van deze waarschuwingen kan leiden tot ernstig letsel of de dood.**

- **Elektrische toestellen zijn geen speelgoed.** Het toestel mag niet worden gebruikt door personen (inclusief kinderen) met verminderd fysiek, zintuigelijk of mentaal vermogen, of gebrek aan kennis en ervaring, tenzij deze personen onder toezicht staan of zijn geïnstrueerd.
- Kinderen moeten onder toezicht staan om te garanderen dat ze niet met het toestel spelen.
- Dit toestel mag worden gebruikt door kinderen vanaf 8 jaar en ouder evenals door personen met verminderd fysiek, zintuigelijk of mentaal vermogen of gebrek aan kennis en ervaring, mits zij onder toezicht staan of zijn geïnstrueerd in het veilig gebruik van het toestel en zij inzicht hebben in de gevaren die het gebruik van het toestel met zich meebrengt.
- De reiniging mag niet worden uitgevoerd door kinderen zonder toezicht.
- Iedereen die betrokken is bij het werken aan of het openen van een koelkring, moet beschikken over een geldig certificaat van een erkende beoordelingsautoriteit, die toestemming geeft om koelmiddelen veilig te gebruiken in overeenstemming met een door de industrie erkende beoordelingspecificatie.
- Het onderhoud mag alleen worden uitgevoerd zoals aanbevolen door de fabrikant van de apparatuur. Onderhoud en reparaties waarbij de hulp van ander bevoegd personeel nodig is, dienen te worden uitgevoerd onder toezicht van de persoon die bekwaam is in het gebruik van brandbare koelmiddelen.
- Reparaties van het toestel mogen uitsluitend worden uitgevoerd door bevoegd personeel dat bekend is met de betreffende gevaren en voorschriften. Door ondeskundige reparaties kunnen grote gevaren ontstaan. Neem voor reparaties contact op met het servicecentrum in uw land (zie [dometic.com/dealer](http://dometic.com/dealer)).
- Onderbreek bij werkzaamheden aan het toestel altijd de stroomtoevoer.
- Het toestel moet worden opgeslagen in een ruimte zonder continu actieve ontstekingsbronnen zoals open vuur, een werkend gastoestel of een elektrische verwarming.
- Doorboor of verbrand het toestel niet.
- Koelmiddelen kunnen geurloos zijn.
- Gebruik het toestel niet in de buurt van ontvlambare vloeistoffen of in gesloten ruimtes.
- Zorg ervoor dat er geen brandbare voorwerpen in de buurt van de luchtuitlaat zijn opgeslagen of gemonteerd. De afstand moet minstens 50 cm bedragen.
- Houd de ventilatieopeningen vrij.
- Beschadig de koelkring niet.
- Onder geen beding mogen potentiële ontstekingsbronnen worden gebruikt om koelmiddellekkages te zoeken of te detecteren. Er mag geen gasontladingslamp (of een andere detector met open vlam) worden gebruikt.
- De dakairconditioning moet worden geïnstalleerd in een voertuig met een vloeroppervlak groter dan 4 m<sup>2</sup>.



**VOORZICHTIG! Het niet in acht nemen van deze waarschuwingen kan leiden tot licht of matig letsel.**

- Grijp niet in luchtuitlaten en steek geen vreemde voorwerpen in het toestel.
- In geval van brand mag u de bovenste afdekking van het toestel niet verwijderen. Gebruik in plaats daarvan goedgekeurde blusmiddelen. Gebruik geen water om branden te blussen.
- Als het netsnoer beschadigd is, moet dit, om gevaren te voorkomen, worden vervangen door de fabrikant, de klantenservice of gelijkwaardig bevoegd personeel.
- Als het toestel een ionisator bevat, raadpleeg dan uw arts als u een medische aandoening hebt. De ionisator kan ozon (O<sub>3</sub>) in kleine hoeveelheden produceren. Als u lijdt aan longziekte, astma, hartziekte, luchtwegaandoening, ademhalingsproblemen, of als u een gevoeligheid voor ozon heeft, raadpleeg dan uw arts om te bepalen of het gebruik van dit toestel veilig voor u is.



**LET OP! Gevaar voor schade**

- Gebruik geen andere middelen om het ontdooiproces te versnellen of om te reinigen dan die welke door de fabrikant worden aanbevolen.
- Het toestel dient zodanig te worden opgeslagen dat mechanische schade wordt voorkomen.
- Voer geen wijzigingen of verbouwingen aan het toestel uit!
- Rijd nooit door de wasstraat wanneer het toestel is gemonteerd.
- Als er storingen optreden in de koelkring, moet het toestel, om gevaren te voorkomen, worden gecontroleerd en gerepareerd door de fabrikant, diens klantenservice of gelijkwaardig bevoegd personeel.

## 4 Beoogd gebruik

De dakairconditioning FreshJet FJX is uitsluitend ontworpen voor montage op het dak van een caravan of recreatievoertuig om koeling te bieden.

De dakairconditioning is **niet** geschikt voor treinen, huizen en appartementen. De dakairconditioning is **niet** geschikt voor montage in bouwmachines, landbouwmachines of dergelijke werktoestellen.

Dit product is alleen geschikt voor het beoogde gebruik en de toepassing in overeenstemming met deze gebruiksaanwijzing.

Deze handleiding geeft informatie die nodig is voor een correcte installatie en/of correct gebruik van het product. Een slechte installatie en/of onjuist gebruik of onderhoud leidt tot onbevredigende prestaties en mogelijke storingen.

De fabrikant aanvaardt geen aansprakelijkheid voor letsel of schade aan het product die het gevolg is van:

- Onjuiste montage of aansluiting, inclusief te hoge spanning
- Onjuist onderhoud of gebruik van andere dan door de fabrikant geleverde originele reserveonderdelen
- Wijzigingen aan het product zonder uitdrukkelijke toestemming van de fabrikant
- Gebruik voor andere doeleinden dan beschreven in deze handleiding

Dometic behoudt zich het recht voor om het uiterlijk en de specificaties van het product te wijzigen.

## 5 Verklaring van de symbolen op het toestel



Let op! Licht ontvlambaar materiaal.



Lees de gebruiksaanwijzing.



Lees de servicehandleiding.

## 6 Technische limieten en voorwaarden

De dakairconditioning is bedoeld voor voertuigen met daken met een dikte van 25 mm ... 60 mm. De werking van de dakairconditioning is gegarandeerd bij omgevingstemperaturen tussen  $-2^{\circ}\text{C}$  ...  $52^{\circ}\text{C}$ . De dakairconditioning is ontworpen om te worden geïnstalleerd binnen  $\pm 10^{\circ}$  van het horizontale vlak. De prestaties van de dakairconditioning kunnen afnemen wanneer deze wordt blootgesteld aan sterke trillingen, bijvoorbeeld door slechte wegomstandigheden.

## 7 Technische beschrijving

De dakairconditioning FreshJet FJX4233M voorziet het interieur van het voertuig van koele lucht, die vrij is van stof en vuil en die kan worden ontvochtigd.

De dakairconditioning FreshJet FJX4233EEH/FJX4333E(EH)/FJX7333IHP/FJX7337IHP/FJX7457IHP voorziet het interieur van het voertuig van koele of warme lucht die vrij is van stof en vuil en die kan worden ontvochtigd.

De dakairconditioning kan de temperatuur in het voertuig verlagen tot een bepaald niveau dat afhankelijk is van het type voertuig, de omgevingstemperatuur en de koelcapaciteit van de dakairconditioning. Onder een buitentemperatuur van  $16^{\circ}\text{C}$  koelt de dakairconditioning niet meer.

De dakairconditioning wordt bediend met de volgende bedieningselementen:

- Bedieningspaneel

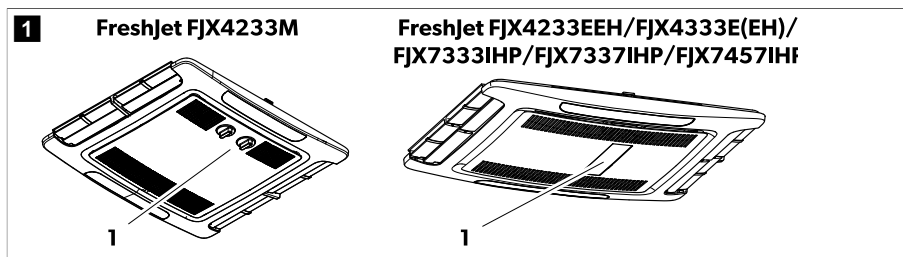

- Afstandsbediening (alleen FJX4233EEH/FJX4333E(EH)/FJX7333IHP/FJX7337IHP/FJX7457IHP)

## 7.1 Lijst met modellen

In de volgende tabel ziet u welke functie van toepassing is op een bepaald model:

● Functie is beschikbaar

○ Functie kan worden toegevoegd

	FJX4233M	FJX4233EEH	FJX4333EEH	FJX4333E	FJX7333IHP	FJX7337IHP	FJX7457IHP
Automatisch		●	●	●	●	●	●
Koelen	●	●	●	●	●	●	●
Verwarmen		●	●	○	●	●	●
Ventilatie	●	●	●	●	●	●	●
Ontvochtiging		●	●	●	●	●	●
Luchtzuiveraar	○	●	●	○	●	●	●
ADB-licht		●	●	○	●	●	●
Extern licht					●	●	●
timer		●	●	●	●	●	●
Sleep		●	●	●	●	●	●
Softstart			●	○	●	●	●

## 7.2 Bedieningspaneel FreshJet FJX4233M

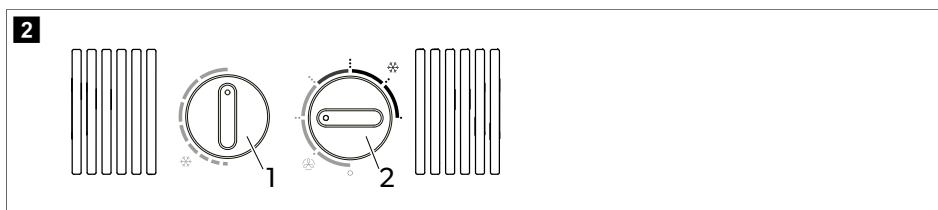

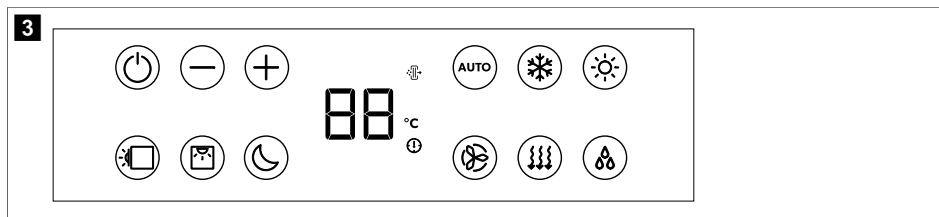

Knop	Beschrijving
	Selecteert de temperatuur. Draai rechtsom voor meer koeling.
	Schakelt u de dakairconditioning in of uit en selecteert de intensiteit van de luchtcirculatie in de ventilatiemodus (🌀) of de koelintensiteit in de koelmodus (❄️).

### 7.3 Bedieningspaneel FreshJet FJX4233EEH/FJX4333E(EH)/FJX7333IHP/ FJX7337IHP/FJX7457IHP



















Symbool	Beschrijving
	Schakelt de dakairconditioning in of in stand-bystand.
	verhoogt de momenteel op het display weergegeven waarde.
	verlaagt de momenteel op het display weergegeven waarde.
	Koppelt met Bluetooth/wifi wanneer beide knoppen tegelijkertijd worden ingedrukt.
	Schakelt de sfeerverlichting in de dakeenheid in of uit.
	Schakelt de sfeerverlichting in de luchtverdeelbox in of uit.
	Activeert de Sleep-functie (Aanvullende functies (alleen FJX4233EEH/FJX4333E(EH)/FJX7333IHP/ FJX7337IHP/FJX7457IHP) op pagina 176).
	Geeft de ingestelde temperatuur weer en duidt de ventilatorstand aan wanneer deze wordt aangepast.
	Geeft aan dat de modus luchtzuiveraar actief is.
	Geeft aan dat de temperatuur wordt weergegeven in graden Celsius.
	Geeft aan dat de timer is ingesteld.
	Activeert/deactiveert de automatische modus (Airconditioningmodi (alleen FJX4233EEH/FJX4333E(E- H)/FJX7333IHP/FJX7337IHP/FJX7457IHP) op pagina 176).
	Activeert/deactiveert de koelmodus (Airconditioningmodi (alleen FJX4233EEH/FJX4333E(EH)/FJX7333IHP/ FJX7337IHP/FJX7457IHP) op pagina 176).
	Activeert/deactiveert de verwarmingsmodus (Airconditioningmodi (alleen FJX4233EEH/FJX4333E(E- H)/FJX7333IHP/FJX7337IHP/FJX7457IHP) op pagina 176).
	Past de ventilatorsnelheid aan tussen Low, Med, High, Turbo of Auto (wordt kort weergegeven als 1, 2, 3, 4 of AA op het display van de luchtverdeelbox wanneer deze wordt gewijzigd).

Symbol	Beschrijving
	Activeert/deactiveert de ventilatiemodus (Airconditioningmodi (alleen FJX4233EEH/FJX4333E(E-H)/FJX7333IHP/FJX7337IHP/FJX7457IHP) op pagina 176). Circuleert lucht zonder verwarming of koeling.
	Activeert/deactiveert de ontvochtigingsmodus (Airconditioningmodi (alleen FJX4233EEH/FJX4333E(E-H)/FJX7333IHP/FJX7337IHP/FJX7457IHP) op pagina 176).

## 7.4 Afstandsbediening FreshJet FJX4233EEH/FJX4333E(EH)/FJX7333IHP/FJX7337IHP/FJX7457IHP





Bedienings- en weergave-elementen afb. **4** op pagina 174:

Knop	Beschrijving
—	<p><b>Display</b></p> <p>Geeft het volgende weer:</p> <ul style="list-style-type: none"> <li>• Tijd</li> <li>• Geselecteerde ruimtetemperatuur (ingestelde waarde) in °C</li> <li>• Werkelijke ruimtetemperatuur</li> <li>• Airconditioningmodus</li> <li>• Ventilatiesnelheid</li> <li>• Symbolen voor actieve aanvullende functies</li> <li>• Batterijstatus</li> </ul>
	Schakelt de dakairconditioning in of in de stand-bymodus.
	verhoogt de momenteel op het display weergegeven waarde.
	verlaagt de momenteel op het display weergegeven waarde.
	Selecteert de ventilatorsnelheid (De ventilatorsnelheid handmatig instellen op pagina 180).
	Selecteert de airconditioningmodus (Airconditioningmodi (alleen FJX4233EEH/FJX4333E(EH)/FJX7333IHP/FJX7337IHP/FJX7457IHP) op pagina 176). Het bijbehorende symbool wordt weergegeven.
	Activeert de Sleep-functie (Aanvullende functies (alleen FJX4233EEH/FJX4333E(EH)/FJX7333IHP/FJX7337IHP/FJX7457IHP) op pagina 176). Het symbool  wordt weergegeven.
	Bevestigt de instellingen en slaat deze op.
	Stelt de timer en de klok in.
	Schakelt de sfeerverlichting in de luchtverdeelbox in of uit.
	<p>Druk één keer om de huidige binnentemperatuur weer te geven. Het symbool  wordt weergegeven.</p> <p>Druk twee keer om de ingestelde temperatuur weer te geven.</p>
	<p>Activeert de functie 'I Feel'. Het symbool  wordt weergegeven.</p> <p>Om de 10 min past de functie 'I Feel' de doeltemperatuur aan aan de actuele temperatuur die wordt gemeten door de afstandsbediening.</p>
	Schakelt de sfeerverlichting in de dakeenheid in of uit.
	Geeft aan dat de batterijen van de afstandsbediening leeg zijn. Vervang de batterijen (Batterijen van de afstandsbediening vervangen op pagina 183).
	Geeft aan dat de afstandsbediening waarden verzendt naar de dakairconditioning.



## 7.5 Airconditioningmodi (alleen FJX4233M)

De dakairconditioning beschikt over de volgende airconditioningmodi:

Airconditioning-modus	Weergegeven symbool	Beschrijving
Koelen		U stelt de temperatuur en ventilatorstand in en de dakairconditioning koelt het interieur tot deze temperatuur.
Ventilatie		U stelt de ventilatorstand in en de dakairconditioning circuleert lucht zonder te verwarmen of te koelen.

## 7.6 Airconditioningmodi (alleen FJX4233EEH/FJX4333E(EH)/FJX7333IHP/FJX7337IHP/FJX7457IHP)

De dakairconditioning beschikt over de volgende airconditioningmodi:

Airconditioning-modus	Weergegeven symbool	Beschrijving
Automatisch	<b>A</b>	U stelt de temperatuur in en de dakairconditioning brengt het interieur op deze temperatuur door te verwarmen of te koelen en door de vereiste ventilatorsnelheid te regelen.
Koelen		U stelt de temperatuur en ventilatorstand in en de dakairconditioning koelt het interieur tot deze temperatuur.
Verwarmen		<b>Niet FJX4333E:</b> U stelt de temperatuur en ventilatorstand in en de dakairconditioning verwarmt het interieur tot deze temperatuur. De ventilator start pas na 2 min (op lage snelheid) en gaat na ca. 5 min naar de ingestelde ventilatorsnelheid (nadat de verdamper op temperatuur is).
Ventilatie		U stelt de ventilatorstand in en de dakairconditioning circuleert lucht zonder te verwarmen of te koelen.
Luchtontvochtiging		De dakairconditioning verwijdert vocht uit de lucht zonder het interieur te verwarmen of te koelen, waardoor de relatieve luchtvochtigheid afneemt.
Luchtzuiveraar		<b>Niet FJX4333E:</b> De dakairconditioning ioniseert de lucht, waardoor stof en deeltjes, waaronder virussen en bacteriën, uit de lucht worden verzameld.

## 7.7 Aanvullende functies (alleen FJX4233EEH/FJX4333E(EH)/FJX7333IHP/FJX7337IHP/FJX7457IHP)

De dakairconditioning heeft de volgende aanvullende functies:



Aanvullende functie	Displaymelding	Beschrijving
timer		De dakairconditioning wordt op het ingestelde tijdstip ingeschakeld.
		De dakairconditioning wordt op het ingestelde tijdstip uitgeschakeld.
		De dakairconditioning wordt op de ingestelde tijdstippen in- en weer uitgeschakeld.
Sleep		De Sleep-functie verlaagt de ventilatorsnelheid en de compressorsnelheid om het geluidsniveau te verlagen, zodat u comfortabel kunt slapen.
I Feel		De afstandsbediening meet de ruimtetemperatuur en geeft de gemeten waarde om de 10 min door aan de dakairconditioning. De dakairconditioning past de instelwaarde aan aan deze meting.
Softstart		<b>Niet FJX4233EEH:</b> De piekstroom die de compressorstart genereert, wordt door de Softstart-functie gereduceerd. Als er een generator als voeding wordt gebruikt, raakt de generator niet overbelast.

## 8 Voor het eerste gebruik

### Controles voor de gebruiknaam

Let op het volgende alvorens de dakairconditioning in te schakelen:

1. Controleer of de voedingsspanning en frequentie overeenkomen met de waarden in Technische gegevens op pagina 190.
2. Zorg ervoor dat zowel de luchtinlaatopeningen als de luchtverdelers vrij zijn. Alle ventilatieroosters moeten altijd vrij worden gehouden, zodat de dakairconditioning op maximaal vermogen kan werken.

### Bereid de afstandsbediening voor (alleen FreshJet FJX4233EEH/FJX4333E(EH)/FJX7333IHP/FJX7337IHP/FJX7457IHP)

3. Plaats de batterijen (Batterijen van de afstandsbediening vervangen op pagina 183).

### Stel de tijd in (alleen FreshJet FJX4233EEH/FJX4333E(EH)/FJX7333IHP/FJX7337IHP/FJX7457IHP)

4. Stel de huidige tijd in (De huidige tijd instellen op pagina 180).

## 9 Gebruik

### 9.1 Tips voor beter gebruik

De volgende tips zullen de werking van uw dakairconditioning optimaliseren:

- Verbeter de warmte-isolatie van het voertuig door openingen af te dichten en de vensters te bedekken met reflecterende (rol)gordijnen.
- Selecteer een geschikte temperatuur en ventilatorstand.
- Stel de luchtverdelers doelmatig af.

- Zorg ervoor dat de luchtverdelers en de luchtinlaat niet afgedekt zijn door doeken, papier of andere voorwerpen.
- **Alleen FreshJet FJX4233EEH/FJX4333E(EH)/FJX7333IHP/FJX7337IHP/FJX7457IHP:** Als het voertuig voor langere tijd in de zon heeft gestaan: Gebruik de dakairconditioning eerst een tijdje in de ventilatiemodus (🌀) met de ramen open, alvorens de koelmodus (❄️) in te schakelen.
- **Alleen FreshJet FJX4233EEH/FJX4333E(EH)/FJX7333IHP/FJX7337IHP/FJX7457IHP:** Open deuren en ramen zo min mogelijk als de koelmodus (❄️) actief is.

## 9.2 Algemene instructies voor bediening

De FreshJet FJX4233M dakairconditioning heeft drie bedrijfsmodi:

Bedrijfsmodus	Beschrijving
Uit	De dakairconditioning is uitgeschakeld.
Koelen	De dakairconditioning koelt het interieur.
Ventilatie	De dakairconditioning circuleert lucht zonder koeling.

De FreshJet FJX4233EEH/FJX4333E(EH)/FJX7333IHP/FJX7337IHP/FJX7457IHP dakairconditioning heeft twee bedrijfsmodi:

Bedrijfsmodus	Beschrijving
Stand-by	De dakairconditioning is gebruiksklaar en kan met de afstandsbediening worden ingeschakeld. De sfeerverlichting is beschikbaar. De afstandsbediening staat ook in stand-by, maar u kunt de afstandsbediening onafhankelijk van de dakairconditioning inschakelen.
Aan	De dakairconditioning klimatiseert het interieur.

## 9.3 Dometic FJX4233M

De informatie in dit hoofdstuk is alleen van toepassing op de dakairconditioning FJX4233M.

### 9.3.1 De dakairconditioning in- en uitschakelen

De dakairconditioning beschikt over twee airconditioningmodi:





- Modus Ventilatie (🌀)
- Modus Koelen (❄️)



**Instructie** Wacht ten minste 30 s voordat u van de ventilatiemodus in de koelmodus schakelt of andersom. Anders kan de omschakelstroom de zekering doen doorbranden.

Elke modus heeft drie instellingen:

- .: Laag

- ...: Medium
- ...: Hoog
- >  Draai de knop naar de modus Ventilatie () of naar de modus Koelen () om deze in te schakelen en selecteer de gewenste instelling.
- ✓ De dakairconditioning wordt ingeschakeld en werkt met de waarden die waren ingesteld toen het toestel werd uitgeschakeld.
- >  Draai de knop naar stand 0 om het toestel uit te schakelen.

### 9.3.2 Temperatuur instellen

- >  Draai de knop in de gewenste stand. Als u de knop rechtersom draait, betekent dit een lagere temperatuur.
- ✓ De temperatuur is ingesteld in de dakairconditioning.

## 9.4 Freshjet FJX4233EEH/FJX4333E(EH)/FJX7333IHP/FJX7337IHP/FJX7457IHP

De informatie in dit hoofdstuk is alleen van toepassing op de dakairconditioning FJX4233EEH/FJX4333E(EH)/FJX7333IHP/FJX7337IHP/FJX7457IHP.

### 9.4.1 Met de afstandsbediening

Houd rekening met de volgende tips bij het gebruik van de afstandsbediening:

- Richt de afstandsbediening op de IR-ontvanger van het bedieningspaneel.
- De bijbehorende instellingen en waarden worden direct naar de dakairconditioning verzonden wanneer u op een knop drukt.
- De dakairconditioning bevestigt de ontvangst van gegevens met een piep.
- Waarden worden sneller verhoogd of verlaagd wanneer u de knop + of – ingedrukt houdt.
- In de stand-bystand is het display van de afstandsbediening ook inactief. U kunt de afstandsbediening onafhankelijk van de dakairconditioning in stand-by schakelen.
- > Als u alleen de afstandsbediening in of uit stand-by wilt schakelen, drukt u op de knop  terwijl u niet naar de IR-ontvanger van het bedieningspaneel wijst.

### 9.4.2 De dakairconditioning inschakelen en in stand-by schakelen

 **Instructie** Wanneer de dakairconditioning wordt ingeschakeld, werkt deze met de waarden die waren ingesteld voordat het toestel naar stand-by werd geschakeld. De dakairconditioning kan alleen worden uitgeschakeld door de stroomvoorziening af te sluiten.





- > Druk op de knop  op de afstandsbediening of op de knop  op het bedieningspaneel om de dakairconditioning in of in stand-by te schakelen.



### 9.4.3 Airconditioningmodus selecteren

- > Selecteer de gewenste airconditioningmodus met behulp van de knop MODE (Airconditioningmodi (alleen FJX4233EEH/FJX4333E(EH)/FJX7333IHP/FJX7337IHP/FJX7457IHP) op pagina 176).
- ✓ De dakairconditioning bevestigt de ontvangst van waarden met een piep. De dakairconditioning wordt in de geselecteerde airconditioningmodus geschakeld.

### 9.4.4 De ventilatorsnelheid handmatig instellen

In alle modi, behalve in de automatische modus (A) en de ontvochtigingsmodus (☺), kan de ventilatorsnelheid handmatig worden geselecteerd.

Displaymelding	Beschrijving
	Lage ventilatorstand
	Gemiddelde ventilatorstand
	Hoge ventilatorstand.
	Ventilatorstand turbo.
	Automatische modus (de ventilatorsnelheid wordt aangepast op basis van de omgevingstemperatuur).

- > Druk op de knop  op de afstandsbediening of op de knop  op het bedieningspaneel om de gewenste ventilatorsnelheid te selecteren.
- ✓ De dakairconditioning bevestigt de ontvangst van waarden met een piep.  
De nieuwe ventilatorstand is ingesteld.

### 9.4.5 Temperatuur instellen

In de modi Automatisch (A), Koelen (❄), Verwarmen (☀) en Ontvochtigen (☺) kunt u een temperatuur tussen 16 °C en 31 °C instellen.

- > Gebruik de knop + of – op de afstandsbediening om de gewenste temperatuur in te stellen.
- ✓ De dakairconditioning bevestigt de ontvangst van de waarden met een hoge toon. De temperatuur is ingesteld in de dakairconditioning.

### 9.4.6 De huidige tijd instellen

De afstandsbediening heeft voor de timerprogrammering de actuele tijd nodig. De tijd wordt weergegeven op het display van de afstandsbediening.

1. Houd de knop  ingedrukt om naar de modus voor het instellen van de tijd te gaan.  
✓ De tijd op het display van de afstandsbediening knippert.
2. Stel met de knop + of – de actuele tijd in. Houd de knop + of – langer dan 2 s ingedrukt om de tijd sneller te verhogen of te verlagen.
3. Druk op de knop SET om de tijd te bevestigen.













## 9.4.7 Timer instellen

Met de Timer-functie kunt u de airco voor een bepaalde periode instellen. U kunt de inschakeltijd, de schakeltijd naar stand-by of beide waarden instellen.

De Timer-functie wordt ingesteld via de afstandsbediening.



**Instructie** Als er tijdens het programmeren van de timer gedurende 15 s geen knop op de afstandsbediening wordt ingedrukt, gaat de afstandsbediening terug naar de voorafgaande modus.







- > Stel de **inschakeltimer** als volgt in:
  - a) Selecteer de gewenste airconditioningmodus en alle vereiste waarden (bijvoorbeeld de temperatuur).
  - b) Schakel de dakairconditioning indien nodig in stand-by.  
De inschakeltimer kan alleen worden ingesteld wanneer de dakairconditioning in **stand-by** staat.
  - c) Druk een keer op de knop .
  - ✓ Het symbool  knippert op het display van de afstandsbediening.
  - d) Stel met de knop + of – het tijdstip in waarop de dakairconditioning moet worden ingeschakeld.
  - e) Druk op de knop .
  - De inschakeltimer is ingesteld. De dakairconditioning wordt ingeschakeld met de geselecteerde airconditioningmodus op het ingestelde tijdstip.
- > Stel de **timer voor schakelen naar stand-by** als volgt in:
  - a) Schakel de dakairconditioning indien nodig in.  
De timer voor schakelen naar stand-by kan alleen worden ingesteld wanneer de dakairconditioning is **ingeschakeld**.
  - b) Druk twee keer op de knop .
  - ✓ Het symbool  knippert op het display van de afstandsbediening.
  - c) Stel met de knop + of – het tijdstip in waarop de dakairconditioning in stand-by moet worden geschakeld.
  - d) Druk op de knop .
  - De timer voor schakelen naar stand-by is ingesteld. De dakairconditioning wordt op het ingestelde tijdstip in stand-by geschakeld.
- > Stel de **inschakeltimer** en de **timer voor schakelen naar stand-by** als volgt in:
  - a) Selecteer de gewenste airconditioningmodus en alle vereiste waarden (bijvoorbeeld de temperatuur).
  - b) Druk drie keer op de knop .
  - ✓ Het symbool  wordt weergegeven op het display van de afstandsbediening. Het ON-symbool knippert.
  - c) Stel met de knop + of – het tijdstip in waarop de dakairconditioning moet worden ingeschakeld.
  - d) Druk op de knop .
  - ✓ Het **OFF**-symbool knippert.
  - e) Stel met de knop + of – het tijdstip in waarop de dakairconditioning in stand-by moet worden geschakeld.
  - f) Druk op de knop .
  - ✓ De tijdstippen voor inschakelen en in stand-by schakelen zijn ingesteld. De dakairconditioning wordt gedurende de ingestelde periode ingeschakeld.
- > Als u de ingestelde timer wilt **annuleren**, drukt u eenmaal op de knop .
- ✓ De symbolen  verdwijnen. Ingestelde waarden worden verworpen.

### 9.4.8 De Sleep-functie instellen

De Sleep-functie is alleen beschikbaar in de modi Koelen (❄️) of Verwarmen (☀️).

De Sleep-functie verlaagt de ventilatorsnelheid om het geluidsniveau te verlagen, zodat u beter kunt slapen.

**Alleen FJX7333IHP/FJX7337IHP/FJX7457IHP:** De Sleep-functie beperkt bovendien het compressortoerental.

- > Ga als volgt te werk om de Sleep-functie in te schakelen:
  - a) Stel de gewenste temperatuur in (Temperatuur instellen op pagina 180).
  - b) Druk op de knop  op de afstandsbediening of op de knop  op het bedieningspaneel.
- ✓ Het symbool  verschijnt op het display van de afstandsbediening. De Sleep-functie is geactiveerd.
  - > Om de Sleep-functie te deactiveren, drukt u op de knop  of  op de afstandsbediening of op de knop  op het bedieningspaneel.
- ✓ Het symbool  verdwijnt van het display van de afstandsbediening. De Sleep-functie is gedeactiveerd.

### 9.4.9 De functie 'I Feel' activeren

Als deze functie actief is meet de afstandsbediening de ruimtetemperatuur en zendt deze meting om de 10 minuten aan de dakairconditioning. De dakairconditioning past de instelwaarde aan aan deze meting. De functie 'I Feel' is alleen actief als de temperatuur tussen +18 °C en +29 °C ligt.

De afstandsbediening mag zich niet in een gedeelte van de ruimte bevinden dat duidelijk warmer of kouder is dan de gemiddelde ruimtetemperatuur. Hij mag bijvoorbeeld niet in de zon of voor de dakairconditioning blijven liggen.

Als de temperatuur tot boven +29 °C stijgt of onder +18 °C daalt, wordt de functie 'I Feel' gedeactiveerd. Het symbool  knippert drie keer op het display en verdwijnt dan.

1. Druk op de knop.
  - ✓ De functie 'I Feel' is geactiveerd.

Het symbool  verschijnt op het display.

2. Richt de afstandsbediening naar de IR-ontvanger op het bedieningspaneel. Anders kunnen de waarden niet aan de dakairconditioning worden gezonden.

### 9.4.10 De sfeerverlichting bedienen







**WAARSCHUWING! Gevaar voor letsel** Het is bij wet verboden om de buitenverlichting te gebruiken tijdens het rijden met het voertuig.

De knop  op de afstandsbediening is actief, zelfs als de afstandsbediening is uitgeschakeld.

**Alleen FreshJet FJX4233EEH/FJX4333E(EH)/FJX7333IHP/FJX7337IHP/FJX7457IHP:**

- > Druk op de knop  op de afstandsbediening of op het bedieningspaneel om de interne verlichting in of uit te schakelen.
- ✓ Het symbool  knippert één keer op het display van de afstandsbediening wanneer de interne verlichting wordt **ingeschakeld**.

- > Ga als volgt te werk om de interne verlichting te dimmen:
  - a) Houd de knop  op de afstandsbediening of op het bedieningspaneel 3 s ingedrukt.
  - b) Wanneer u op de knop  van de afstandsbediening drukt: druk op de knop  om de interne verlichting tussen 50 % en 100 % te dimmen.
  - c) Wanneer u op de knop  op het bedieningspaneel drukt: de lichtsterkte van de interne verlichting wisselt tussen 50 % en 100 %. Laat de knop  los wanneer de gewenste lichtsterkte is bereikt.

#### Alleen Freshjet FJX7333IHP/FJX7337IHP/FJX7457IHP:

- > Druk op de knop  op het bedieningspaneel om de externe verlichting in of uit te schakelen.

### 9.4.11 Batterijen van de afstandsbediening vervangen

 **Instructie** Het display van de afstandsbediening kan nog steeds helder zijn, zelfs als de batterijen bijna leeg zijn. Vervang de batterijen als de afstandsbediening aangeeft dat de batterijen bijna leeg zijn.

- > Vervang de batterijen zoals afgebeeld.

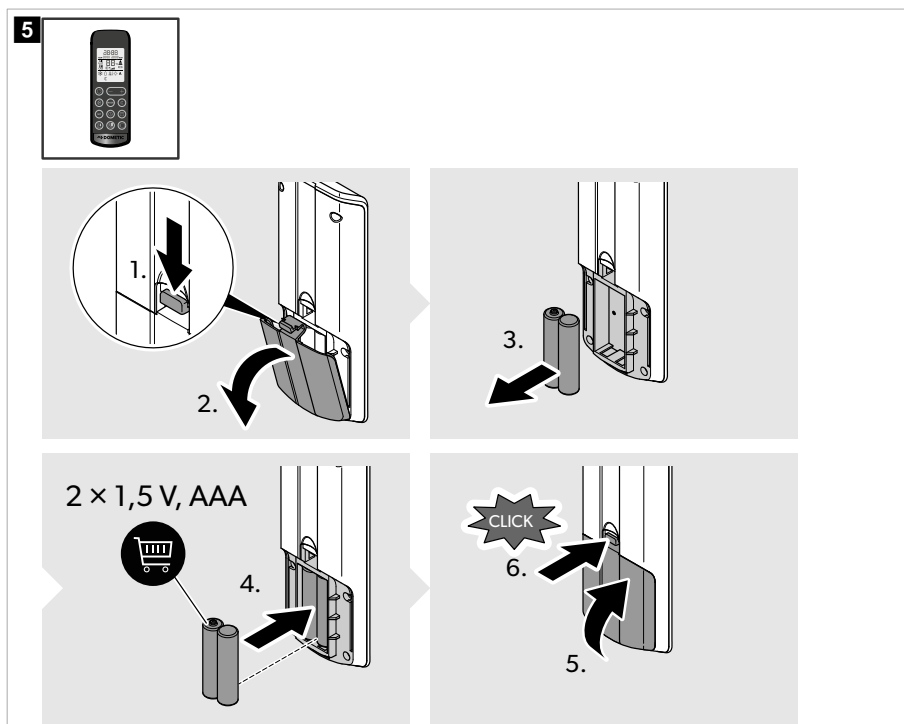

- ✓ Het display toont alle symbolen voor 5 s.



Bescherm het milieu! Accu's en batterijen horen niet thuis in het huishoudelijke afval. Geef uw defecte accu's of verbruikte batterijen af bij de leverancier of bij een verzamelpunt.

## 9.5 De luchttoevoer in het voertuig regelen

De luchtstroom kan langs het plafond worden gericht of naar de grond.

- > Draai de lamellen in de luchtverdelers apart in de gewenste richtingen.

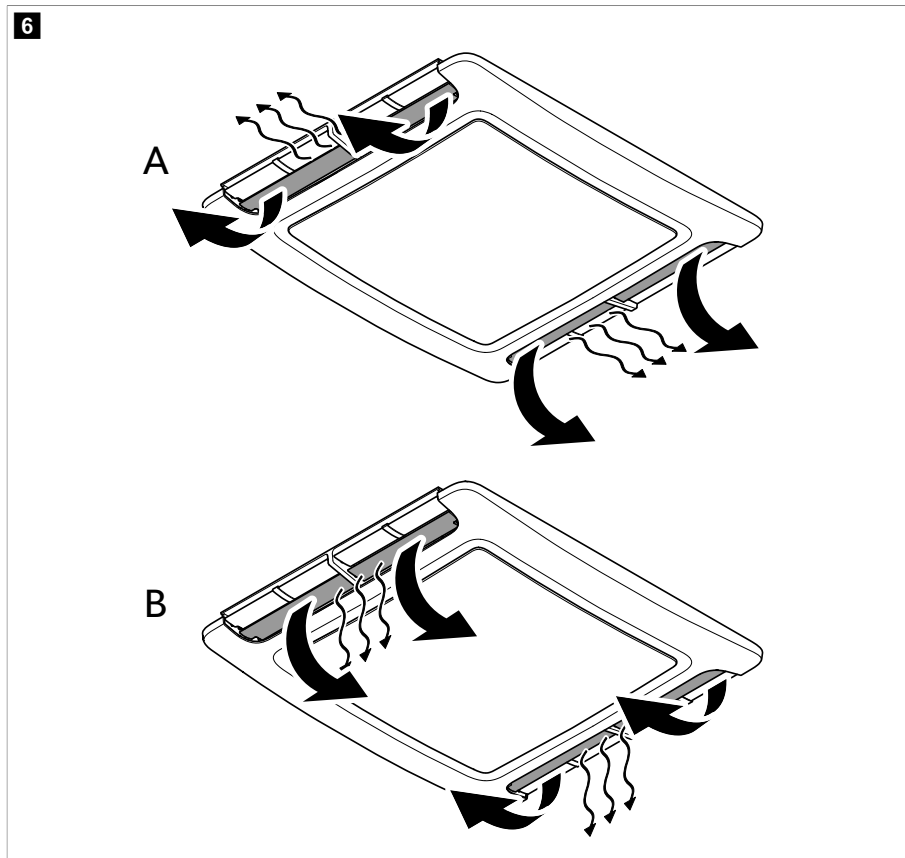



## 10 De dakairconditioning reinigen



### LET OP! Gevaar voor schade

- Gebruik geen andere middelen om het ontdooiproces te versnellen of om te reinigen dan die welke door de fabrikant worden aanbevolen.
- Reinig de dakairconditioning niet met een hogedrukreiniger. Binnendringend water kan de dakairconditioning beschadigen.
- Gebruik geen scherpe of harde voorwerpen of reinigingsmiddelen bij de reiniging, omdat de dakairconditioning hierdoor beschadigd kan raken.
- Gebruik in geen geval benzine, diesel of oplosmiddelen.

1. Verwijder regelmatig bladeren en ander vuil van de luchtinlaat en de ventilatieroosters van de dakairconditioning. Beschadig de ventilatieroosters tijdens het proces niet.

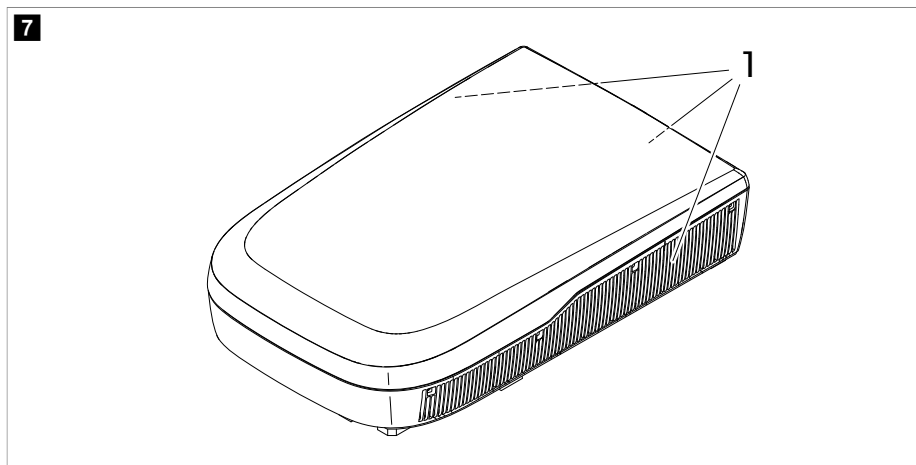

2. Reinig de behuizingen van de dakeenheid en de luchtverdeelbox af en toe met een vochtige doek. Gebruik alleen water met een mild reinigingsmiddel.
3. **Alleen FreshJet FJX4233EEH/FJX4333E(EH)/FJX7333IHP/FJX7337IHP/FJX7457IHP:** Maak de afstandsbediening af en toe schoon met een licht vochtige doek. Reinig het display met een reinigingsdoekje voor brillen.
4. **Alleen FreshJet FJX4233EEH/FJX4333E(EH)/FJX7333IHP/FJX7337IHP/FJX7457IHP** Reinig het display van de luchtverdeelbox af en toe met een milde oplossing van warm water met zeep. Het display is van acryl en kan beschadigd raken door een aantal gangbare huishoudelijke chemicaliën, zoals chemische reinigingsmiddelen, glasreinigers, alcohol, bepaalde tensiden, organische oplosmiddelen en ontharders.

## 11 Onderhoud

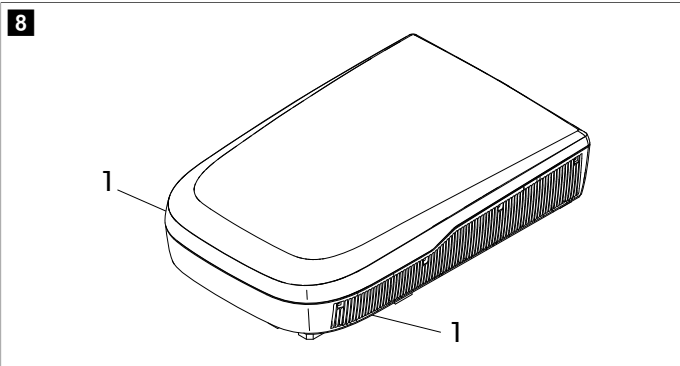
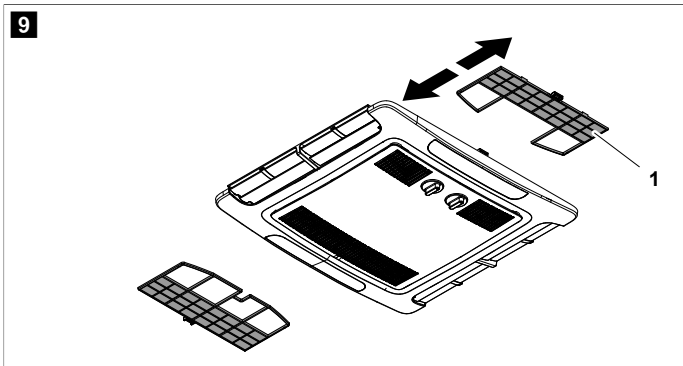

**WAARSCHUWING! Gevaar voor letsel!** Andere onderhoudswerkzaamheden dan degene die hier worden beschreven, mogen alleen worden uitgevoerd door bevoegd personeel dat bekend is met de gevaren bij het gebruik van koelmiddelen en airco's alsmede met de betreffende voorschriften.

Interval	Controle/onderhoud
Regelmatig	<p data-bbox="333 188 1002 231">Controleer of de condenswaterafvoerkanalen (1) aan de zijkanten van de dakairconditioning schoon zijn en het condenswater kan ontsnappen.</p> <div data-bbox="333 247 1016 614"><p data-bbox="341 255 364 279"><b>8</b></p></div>
Regelmatig (FreshJet FJX4233M)	<p data-bbox="333 643 644 667">Reinig het filter van de luchtuitlaatenheid.</p> <div data-bbox="333 678 1016 1045"><p data-bbox="341 686 364 710"><b>9</b></p></div> <ol data-bbox="347 1061 907 1125" style="list-style-type: none"><li>1. Verwijder het filter (1).</li><li>2. Reinig het filter (1) met een reinigingsmiddeloplossing en laat het drogen.</li><li>3. Plaats het droge filter (1) er weer in.</li></ol>

Interval	Controle/onderhoud
Regelmatig (FreshJet FJX4233EEH/FJX4333E(E- H)/FJX7333IHP/ FJX7337IHP/FJX7457IHP)	<ul style="list-style-type: none"> <li>Reinig het filter van de luchtuitlaatenheid.</li> </ul> <div data-bbox="367 225 1016 528" style="border: 1px solid black; padding: 10px; margin: 10px 0;"> </div> <ol style="list-style-type: none"> <li>Steek een platte schroevendraaier of een mes in het handvat (1) om de filters (2) er iets uit de trekken.</li> <li>Verwijder de filters handmatig.</li> <li>Reinig de filters met een reinigingsmiddeloplossing en laat ze drogen.</li> <li>Schuif de droge filters er weer in,afb. 10 op pagina 187</li> </ol> <ul style="list-style-type: none"> <li>Laat de warmtewisselaar van de dakairconditioning onderhouden door een gespecialiseerd bedrijf.</li> </ul>
Eén keer per jaar	<ul style="list-style-type: none"> <li>Controleer de afdichtingen tussen de dakairconditioning en het voertuigdak op scheuren en andere beschadigingen.</li> <li>Controleer of de bevestigingsschroeven zijn vastgedraaid met het juiste aanhaalmoment (<math>2.5 \text{ Nm} \pm 0.3 \text{ Nm}</math>) en draai ze eventueel aan.</li> </ul>

## 12 Problemen oplossen

Fout	Mogelijke oorzaak	Voorstel tot oplossing
Koelt niet goed.	De dakairconditioning is niet ingesteld op koelen.	Stel de dakairconditioning in op koelen.
	De omgevingstemperatuur is hoger dan 52 °C.	De dakairconditioning is ontworpen voor een omgevingstemperatuur tot 52 °C.
	De ingestelde temperatuur is hoger dan de ruimtetemperatuur.	Selecteer een lagere temperatuur.
	De omgevingstemperatuur is lager dan 16 °C.	De dakairconditioning is alleen ontworpen voor koeling bij omgevingstemperaturen boven 16 °C.
	Eén van de temperatuursensoren is defect.	Neem contact op met een geautoriseerde klantenservice of Dometic.
	De verdampventilator is beschadigd.	Neem contact op met een geautoriseerde klantenservice of Dometic.

Fout	Mogelijke oorzaak	Voorstel tot oplossing
	De condensorventilator is beschadigd.	Neem contact op met een geautoriseerde klantenservice of Dometic.
<b>Alleen FreshJet FJX4233EEH/ FJX4333E(EH)/FJX7333IHP/ FJX7337IHP/FJX7457IHP:</b> Verwarmt niet goed.	De dakairconditioning is niet ingesteld op verwarmen.	Stel de dakairconditioning in op verwarmen.
	De omgevingstemperatuur is lager dan $-2\text{ }^{\circ}\text{C}$ .	De dakairconditioning is ontworpen voor omgevingstemperaturen hoger dan $-2\text{ }^{\circ}\text{C}$ .
	De ingestelde temperatuur is lager dan de ruimtetemperatuur.	Selecteer een hogere temperatuur.
	Eén van de temperatuursensoren is defect.	Neem contact op met een geautoriseerde klantenservice of Dometic.
	De verdampventilator is beschadigd.	Neem contact op met een geautoriseerde klantenservice of Dometic.
Geringe luchtstroom	De luchtinlaatopeningen zijn geblokkeerd of afgedekt.	Verwijder bladeren en ander vuil van de ventilatieroosters van de dakairconditioning.
	De ventilator is defect.	Neem contact op met een geautoriseerde klantenservice of Dometic.
Water lekt in het voertuig.	De afvoeropeningen voor condenswater zijn verstopt.	Verwijder condenswater uit de waterafvoeropeningen.
	De afdichtingen zijn beschadigd.	Neem contact op met een geautoriseerde klantenservice of Dometic.
De dakairconditioning schakelt niet in.	Geen stroomvoorziening aangesloten.	Controleer de stroomvoorziening.
	De spanning is te laag ( $< 200\text{ V}$ ).	Neem contact op met een geautoriseerde klantenservice of Dometic.
	De spanningsomvormer is defect.	Neem contact op met een geautoriseerde klantenservice of Dometic.
	Eén van de temperatuursensoren is defect.	Neem contact op met een geautoriseerde klantenservice of Dometic.
	De elektrische zekering van de stroomvoorziening is te klein.	Neem contact op met een geautoriseerde klantenservice of Dometic.
De dakairconditioning schakelt niet uit.	Eén van de temperatuursensoren is defect.	Neem contact op met een geautoriseerde klantenservice of Dometic.
	De elektrische zekering van de stroomvoorziening is te klein.	Neem contact op met een geautoriseerde klantenservice of Dometic.
<b>Alleen FreshJet FJX4233EEH/ FJX4333E(EH)/FJX7333IHP/ FJX7337IHP/FJX7457IHP:</b> De dakairconditioning schakelt steeds uit.	De ijsensor heeft geschakeld.	De buitentemperatuur is te laag of alle luchtverdelers zijn gesloten.

<b>Fout</b>	<b>Mogelijke oorzaak</b>	<b>Voorstel tot oplossing</b>
In het display verschijnt: P0	Te hoge temperatuur of overstroom in IPM-module	Neem contact op met een geautoriseerde klantenservice of Dometic.
In het display verschijnt: P1	Onderspanningsbeveiliging	Neem contact op met een geautoriseerde klantenservice of Dometic.
In het display verschijnt: P2	AC-overstroombeveiliging van de eenheid	Neem contact op met een geautoriseerde klantenservice of Dometic.
In het display verschijnt: P4	Oververhittingsbeveiliging afvoerbuis	Neem contact op met een geautoriseerde klantenservice of Dometic.
In het display verschijnt: P5	Verdamperspoelbescherming (koelmodus)	Neem contact op met een geautoriseerde klantenservice of Dometic.
In het display verschijnt: P6	Condensorspoelbescherming (koelmodus)	Neem contact op met een geautoriseerde klantenservice of Dometic.
In het display verschijnt: P7	Verdamperspoelbescherming (verwarmingsmodus)	Neem contact op met een geautoriseerde klantenservice of Dometic.
In het display verschijnt: P9	Compressoraandrijving abnormaal of compressor start niet	Neem contact op met een geautoriseerde klantenservice of Dometic.
In het display verschijnt: E0	Communicatiefout	Neem contact op met een geautoriseerde klantenservice of Dometic.
In het display verschijnt: E1	Fout ruimtetemperatuursensor	Neem contact op met een geautoriseerde klantenservice of Dometic.
In het display verschijnt: E2	Fout temperatuursensor verdamperspoel	Neem contact op met een geautoriseerde klantenservice of Dometic.
In het display verschijnt: E3	Fout temperatuursensor condensorspoel	Neem contact op met een geautoriseerde klantenservice of Dometic.
In het display verschijnt: E7	Fout buitentemperatuursensor	Neem contact op met een geautoriseerde klantenservice of Dometic.
In het display verschijnt: E8	Fout temperatuursensor afvoerbuis	Neem contact op met een geautoriseerde klantenservice of Dometic.
In het display verschijnt: E9	Fout compressoraandrijving of IPM-module	Neem contact op met een geautoriseerde klantenservice of Dometic.
In het display verschijnt: EA	Fout stroomsensor	Neem contact op met een geautoriseerde klantenservice of Dometic.
In het display verschijnt: EE	EEPROM-fout buiten	Neem contact op met een geautoriseerde klantenservice of Dometic.
In het display verschijnt: EL	LIN-BUS/CI-BUS communicatiefout	Neem contact op met een geautoriseerde klantenservice of Dometic.

## 13 Verwijdering



Gooi het verpakkingsmateriaal indien mogelijk altijd in recyclingafvalbakken. Vraag het dichtstbijzijnde recyclingcentrum of uw dealer naar informatie over hoe het product kan worden weggegooid in overeenstemming met alle van toepassing zijnde nationale en lokale regelgeving.



Bescherm het milieu! Accu's en batterijen horen niet thuis in het huishoudelijke afval. Geef uw defecte accu's of verbruikte batterijen af bij de leverancier of bij een verzamelpunt.

## 14 Garantie

De wettelijke garantieperiode is van toepassing. Neem contact op met de vestiging van de fabrikant in uw land (zie [dometic.com/dealer](http://dometic.com/dealer)) of met uw dealer als het product defect is.

Stuur voor de afhandeling van reparaties of garantie volgende documenten mee:

- Een kopie van de factuur met datum van aankoop
- De reden voor de claim of een beschrijving van de fout

Houd er rekening mee dat eigenmachtige of niet-professionele reparatie gevolgen voor de veiligheid kan hebben en dat de garantie hierdoor kan komen te vervallen.

## 15 Technische gegevens

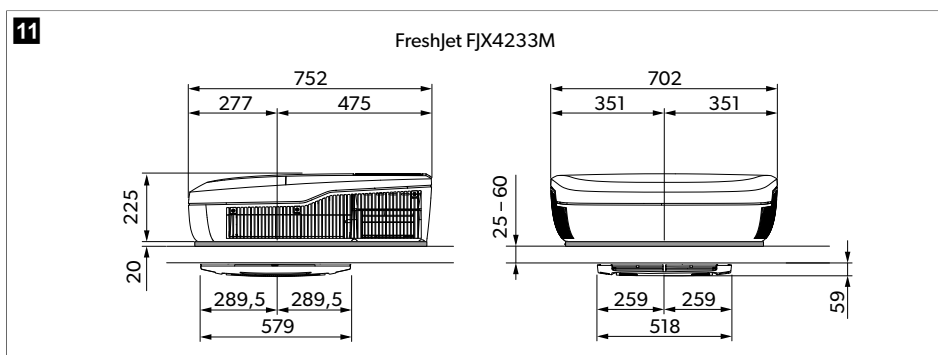

12

FJX4233EEH, FJX4333E(EH), FJX7333IHP

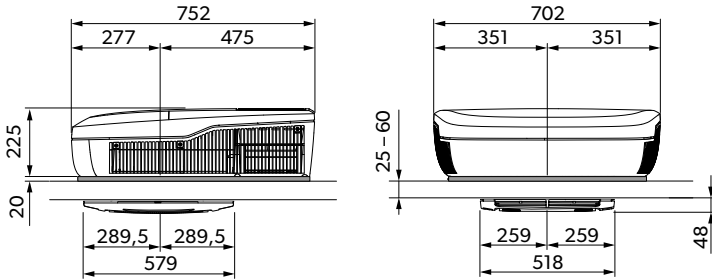

13

FreshJet FJX7337IHP

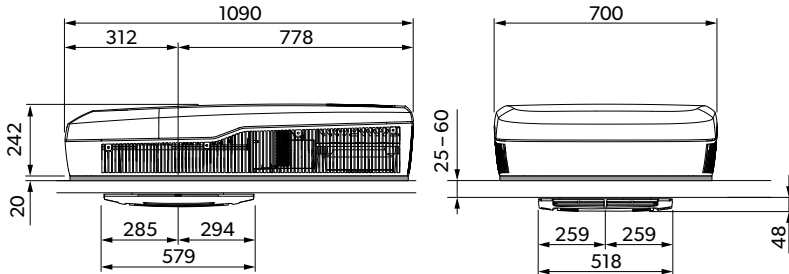

14

FreshJet FJX7457IHP

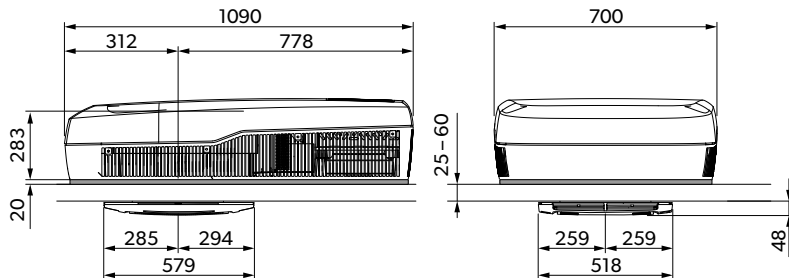

Bevat gefluoreerde broeikasgassen. Hermetisch afgesloten systeem.

	FreshJet FJX4233M
Koelvermogen volgens ISO 5151:	1500 W
AC-ingangsspanning:	220 V ... 240 V / 50 Hz

	<b>FreshJet FJX4233M</b>
Nominale stroom koeling:	< 3.3 A
Benodigde zekering:	4 A
Bedrijfstemperatuurbereik:	- 2 °C ... 52 °C
Koelmiddel:	R410a
Koelmiddelhoeveelheid:	380 g
CO <sub>2</sub> -equivalent:	0.793 t
Aardopwarmingsvermogen (GWP):	2088
Beschermingsgraad (dakeenheid):	IPX4
Geluidsniveau (hoogste ventilatorinstelling)	< 70 dB(A)
Aanbevolen max. voertuiglengte (met geïsoleerde wanden):	< 5 m
Afmetingen l x b x h:	afb. <b>11</b> op pagina 190
Gewicht:	< 30 kg
Keuring/certificering:	

	<b>FreshJet FJX4233EEH</b>	<b>FreshJet FJX4333EEH</b>	<b>FreshJet FJX4333E</b>
Koelvermogen volgens ISO 5151:	1700 W	2200 W	2200 W
Verwarmingsvermogen volgens ISO 5151:	800 W	1000 W	-
AC-ingangsspanning:	220 V ... 240 V / 50 Hz		
Nominale stroom koeling:	3.6 A	4.8 A	4.8 A
Nominale stroom verwarming:	< 5.2 A	< 5.2 A	-
Benodigde zekering:	4 A	5 A	6 A
Bedrijfstemperatuurbereik:	- 2 °C ... 52 °C		
Koelmiddel:	R32		
Koelmiddelhoeveelheid:	320 g	360 g	360 g



	<b>FreshJet FJX4233EEH</b>	<b>FreshJet FJX4333EEH</b>	<b>FreshJet FJX4333E</b>
CO <sub>2</sub> -equivalent:	0.216 t	0.243 t	0.243 t
Aardopwarmingsvermogen (GWP):		675	
Beschermingsgraad (dakeenheid):		IPX4	
Geluidsniveau (hoogste ventilatorinstelling)		< 70 dB(A)	
Aanbevolen max. voertuiglengte (met geïsoleerde wanden):	< 6 m	< 7 m	< 7 m
Afmetingen l x b x h:	afb. <b>12</b> op pagina 191		
Gewicht:	< 30 kg	< 30 kg	< 30 kg
Keuring/certificering:			

	<b>FreshJet FJX7333IHP</b>	<b>FreshJet FJX7337IHP</b>	<b>FreshJet FJX7457IHP</b>
Koelvermogen volgens ISO 5151:	2200 W	3000 W	3500 W
Verwarmingsvermogen volgens ISO 5151:	2000 W	2500 W	3000 W
AC-ingangsspanning:	220 V ... 240 V / 50 Hz ... 60 Hz	220 V ... 240 V / 50 Hz ... 60 Hz	220 V ... 240 V / 50 Hz ... 60 Hz
Nominale stroom koeling:	< 7.5 A	< 7.5 A	< 7.5 A
Nominale stroom verwarming:	< 6.1 A	< 6.1 A	< 6.1 A
Benodigde zekering:	6 A	6 A	6 A
Bedrijfstemperatuurbereik:	- 2 °C ... 52 °C	- 2 °C ... 52 °C	- 2 °C ... 52 °C
Koelmiddel:	R32	R32	R32
Koelmiddelhoeveelheid:	420 g	480 g	650 g
CO <sub>2</sub> -equivalent:	0.2835 t	0.3240 t	0.43875 t
Aardopwarmingsvermogen (GWP):		675	
Beschermingsgraad (dakeenheid):		IPX4	

	<b>FreshJet FJX7333IHP</b>	<b>FreshJet FJX7337IHP</b>	<b>FreshJet FJX7457IHP</b>
Geluidsniveau (hoogste ventilatorinstelling)	< 70 dB(A)		
Aanbevolen max. voertuiglengte (met geïsoleerde wanden):	< 7 m	< 7 m	> 8 m
Afmetingen l x b x h:	afb. <b>12</b> op pagina 191	afb. <b>13</b> op pagina 191	afb. <b>14</b> op pagina 191
Gewicht:	< 30 kg	< 35 kg	< 40 kg
Keuring/certificering:			

## Danish

1	Important notes.....	195
2	Forklaring af symboler.....	195
3	Sikkerhedshenvisninger.....	196
4	Korrekt brug.....	197
5	Forklaringer af symbolerne på apparatet.....	198
6	Tekniske grænser og betingelser.....	198
7	Teknisk beskrivelse.....	198
8	Før første brug.....	204
9	Betjening.....	204
10	Rengøring af tagklima-lægget.....	212
11	Vedligeholdelse.....	212
12	Udbedring af fejl.....	214
13	Bortskaffelse.....	217
14	Garanti.....	217
15	Tekniske data.....	217

## 1 Important notes

Læs og følg alle disse anvisninger, retningslinjer og advarsler i denne produktvejledning grundigt for at sikre, at du altid installerer, bruger og vedligeholder produktet korrekt. Disse anvisninger SKAL opbevares sammen med dette produkt.

Ved at benytte produktet bekræfter du hermed, at du har læst alle anvisninger, retningslinjer og advarsler grundigt, og at du forstår og er indforstået med de vilkår og betingelser, der er fastlagt heri. Du er indforstået med kun at bruge dette produkt til det beregnede formål og anvendelse i overensstemmelse med anvisningerne, retningslinjerne og advarslerne i denne produktvejledning samt i overensstemmelse med alle de gældende love og forskrifter. Manglende læsning og ignorering af disse anvisninger og advarsler kan medføre kvæstelser på dig selv og andre, skade på dit produkt eller skade på anden ejendom i nærheden. Der tages forbehold for eventuelle ændringer og opdateringer af denne produktvejledning samt anvisningerne, retningslinjerne og advarslerne samt den tilhørende dokumentation. Se [documents.dometic.com](http://documents.dometic.com) for de nyeste produktinformationer.

## 2 Forklaring af symboler



**FARE!** Angiver en farlig situation, som medfører dødsfald eller alvorlig kvæstelse, såfremt den ikke undgås.



**ADVARSEL!** Angiver en farlig situation, som medfører dødsfald eller alvorlig kvæstelse, såfremt den ikke undgås.



**FORSIGTIG!** Angiver en farlig situation, som kan medføre mindre eller lette kvæstelser, såfremt den ikke undgås.



**VIGTIGT!** Angiver en farlig situation, som kan medføre mindre eller lette kvæstelser, såfremt den ikke undgås.



**Bemærk** Supplerende informationer om betjening af produktet.

### 3 Sikkerhedshenvisninger



**ADVARSEL! Manglende overholdelse af disse advarsler kan medføre dødelige eller alvorlige kvæstelser.**

- **El-apparater er ikke legetøj.** Apparatet må ikke anvendes af personer (inkl. børn), der har begrænsede fysiske, sanse- eller mentale evner eller er uerfarne og uvidende, medmindre de er under opsyn eller blev instrueret.
- Børn skal overvåges for at sikre, at de ikke leger med apparatet.
- Dette apparat kan anvendes af børn over 8 år og personer, der har begrænsede fysiske, sanse- eller mentale evner eller er uerfarne eller uvidende, hvis de er under opsyn eller blev instrueret i sikker brug af apparatet og forstår de involverede farer.
- Rengøring må ikke udføres af børn uden opsyn.
- Alle personer, som arbejder på eller åbner kølekredsløbet, skal være indehaver af et gyldigt certifikat fra et industri-akkrediteret vurderingsorgan, som autoriserer deres kompetence til at håndtere kølemidler sikkert i overensstemmelse med en industri-ankendt vurderingsspecifikation.
- Vedligeholdelsen må kun udføres som anbefalet af udstyrproducenten. Vedligeholdelse og reparation, der kræver hjælp fra andre fagfolk, skal udføres under opsyn af den person, der er kompetent, hvad angår brugeren brændbare kølemidler.
- Apparatet må kun repareres af kvalificeret personale, som kender de involverede risici og de relevante forskrifter. Ved ukorrekte reparationer kan der opstå alvorlige farer. Ved reparationer skal du henvende dig til serviceafdelingen i dit land ([sedomatic.com/dealer](http://sedomatic.com/dealer)).
- Afbryd altid strømforsyningen ved arbejder på apparatet.
- Apparatet skal opbevares i et rum uden antændelseskilder, der kører konstant som f.eks. åben ild, et anvendt gasapparat eller en anvendt el-varmer.
- Apparatet må ikke gennembores eller brændes.
- Vær opmærksom på, at kølemidler ikke nødvendigvis har en bestemt lugt.
- Anvend ikke apparatet i nærheden af antændelige væsker eller i lukkede rum.
- Kontrollér, at ingen brændbare genstande placeres eller monteres, hvor luften strømmer ud. Afstanden skal være på min. 50 cm.
- Ventilationsåbningerne må ikke obstrueres.
- Beskadig ikke kølekredsløbet.
- Der må under ingen omstændigheder anvendes potentielle antændelseskilder for at søge efter kølemiddellækager. Der må ikke anvendes en bunsenbrænder (eller andet udstyr med åben flamme).
- Tagklimaanelægget skal monteret i et køretøj med et bundområde, der er større end 4 m<sup>2</sup>.



**FORSIGTIG! Manglende overholdelse af disse forsigtighedshenvisninger kan medføre mindre eller moderate kvæstelser.**

- Grib ikke ind i luftudtagene, og stik ikke fremmedlegemer ind i apparatet.
- Løsn i tilfælde af brand ikke det øverste dæksel på apparatet. Anvend i stedet for tilladte brandslukningsmidler. Anvend ikke vand til slukning.
- Hvis strømkablet er beskadiget, skal det udskiftes af producenten, dennes servicerepræsentant eller tilsvarende fagfolk for at undgå en fare.
- Såfremt apparatet indeholder ioniseringsanordning, skal du kontakte din læge, hvis du lider af en sygdom. Ioniseringsanordningen kan fremstille ozon (O<sub>3</sub>) i små mængder. Hvis du lider af lungesygdomme, astma, hjertesygdomme, luftvejssygdomme eller er overfølsom over for ozon, skal du kontakte din læge for at bestemme, om brugen af dette apparat er sikker for dig.



**VIGTIGT! Fare for beskadigelse**

- Du må ikke benytte andre tiltag til at accelerere afrimningsprocessen eller til rengøring bortset fra dem, der anbefales af producenten.
- Apparatet skal opbevares, så der ikke opstår mekaniske skader.
- Foretag ikke ændringer af apparatet eller ombygninger på det!
- Kør aldrig ind i vaskeanlæg, når apparatet er monteret.
- Hvis der opstår fejl i kølemiddelkredsløbet, skal apparatet kontrolleres og udskiftes af producenten, dennes servicerepræsentant eller tilsvarende fagfolk for at undgå en fare.

## 4 Korrekt brug

Tagklimaanelægget FreshJet FJX er kun beregnet til montering på en campingvogns eller en autocampers tag med henblik på køling.

Tagklimaanelægget er **ikke** egnet til toge, huse og lejligheder. Tagklimaanelægget er **ikke** egnet til montering i entreprenørmaskiner, landbrugsmaskiner eller lignende arbejdsudstyr.

Dette produkt er kun egnet til dets beregnede formål og anvendelse i overensstemmelse med disse anvisninger.

Denne vejledning giver dig oplysninger om, hvad der er nødvendigt med henblik på en korrekt montering og/eller drift af produktet. Dårlig montering og/eller ukorrekt drift eller vedligeholdelse medfører utilstrækkelig ydeevne og mulige fejl.

Producenten påtager sig intet ansvar for kvæstelser eller skader i forbindelse med produktet, der skyldes:

- ukorrekt samling eller forbindelse inklusive for høj spænding
- ukorrekt vedligeholdelse eller brug af uoriginale reservedele, der ikke stammer fra producenten
- ændringer på produktet uden udtrykkelig tilladelse fra producenten
- brug til andre formål end dem, der er beskrevet i vejledningen.

Dometic forbeholder sig ret til at ændre produktets udseende og produktspecifikationer.

## 5 Forklaringer af symbolerne på apparatet



Advarsel! Materiale, der brænder langsomt.



Læs betjeningsvejledningen.



Læs servicevejledningen.

## 6 Tekniske grænser og betingelser

Tagklima anlægget er beregnet til køretøjer med tage, der har en tykkelse på 25 mm ... 60 mm. Tagklima anlæggets funktion er garanteret ved omgivelsestemperaturer på mellem  $-2^{\circ}\text{C}$  ...  $52^{\circ}\text{C}$ . Tagklima anlægget er designet til at blive monteret inden for  $\pm 10^{\circ}$  for det vandrette niveau. Tagklima anlæggets ydeevne kan nedsættes, når det udsættes for kraftige vibrationer, f.eks. som følge af dårlige veje.

## 7 Teknisk beskrivelse

Tagklima anlægget FreshJet FJX4233M forsyner køretøjets kabine med kold luft, som er uden støv og snavs og som kan affugtes.

Tagklima anlægget FreshJet FJX4233EEH/FJX4333E(EH)/FJX7333IHP/FJX7337IHP/FJX7457IHP forsyner køretøjets kabine med kold eller varm luft, som er uden støv eller snavs og som kan affugtes.

Tagklima anlægget kan sænke temperaturen i køretøjet til et bestemt niveau, der afhænger af køretøjets type, omgivelsestemperaturen og tagklima anlæggets kølekapacitet. Under en udvendig temperatur på  $16^{\circ}\text{C}$  køler tagklima anlægget ikke længere.

Tagklima anlægget betjenes med følgende betjeningsselementer:

- Betjeningspanel

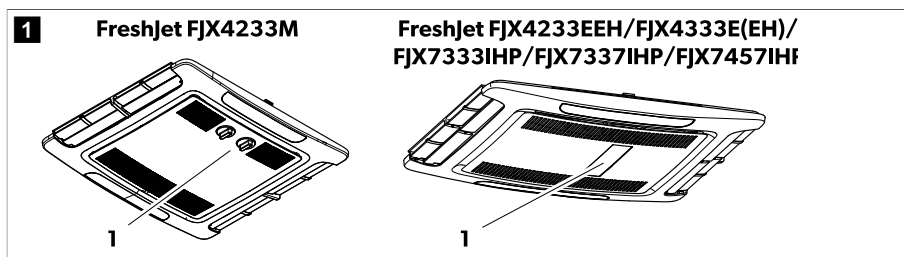

- Fjernbetjening (kun FJX4233EEH/FJX4333E(EH)/FJX7333IHP/FJX7337IHP/FJX7457IHP)

## 7.1 Liste over modeller



Den følgende tabel viser, hvilken funktion der gælder for en bestemt model:

- Funktioner findes
- Funktionen er ekstraudstyr

	FJX4233M	FJX4233EEH	FJX4333EEH	FJX4333E	FJX7333IHP	FJX7337IHP	FJX7457IHP
Automatisk		●	●	●	●	●	●
Køling	●	●	●	●	●	●	●
Opvarmning		●	●	○	●	●	●
Ventilation	●	●	●	●	●	●	●
Affugtning		●	●	●	●	●	●
Luftrenser	○	●	●	○	●	●	●
ADB-lys		●	●	○	●	●	●
Eksternt lys					●	●	●
Timer		●	●	●	●	●	●
Sleep		●	●	●	●	●	●
Soft start			●	○	●	●	●

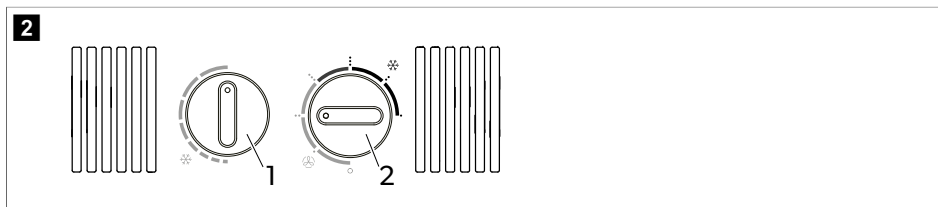
## 7.2 Kontrolpanel FreshJet FJX4233M



knap	Beskrivelse
	Vælger temperaturen. Drej med uret for kraftigere køling.
	Tænder og slukker for tagklimaanelægget og vælger intensiteten for luftcirkulationen på ventilationsmodus (☼) eller køleintensiteten på kølemodus (☼*).

### 7.3 Kontrolpanel til Freshjet FJX4233EEH/FJX4333E(EH)/FJX7333IHP/ FJX7337IHP/FJX7457IHP

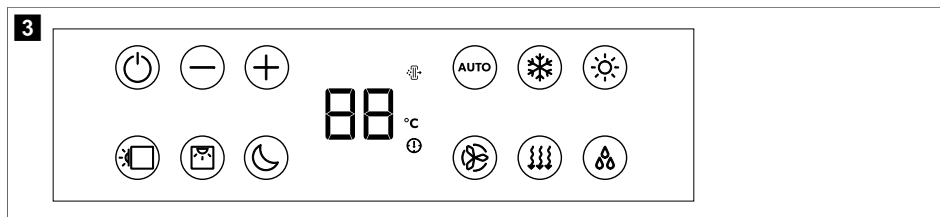

Symbol	Beskrivelse
	Tænder for tagklima anlægget eller indstiller det på standbytilstand.
	Forøger den aktuelt viste værdi.
	Reducerer den aktuelt viste værdi.
	Parres med Bluetooth/WLAN, når der trykkes på begge knapper samtidigt.
	Tænder eller slukker for omgivelseslysene i tagenheden.
	Tænder eller slukker for omgivelseslysene i luftfordelingsboksen.
	Aktiverer sleep-funktionen (Yderligere funktioner (kun FJX4233EEH/FJX4333E(EH)/FJX7333IHP/FJX7337IHP/ FJX7457IHP) på side 203).
	Viser den indstillede temperatur og viser blæsertrinnet, når blæseren er justeret.
	Indikerer, at AirPurifier-tilstand er aktiv.
	Indikerer, at temperaturen vises i grader celsius.
	Viser, at timeren er indstillet.
	Aktiverer/deaktiverer den automatiske tilstand (Ventilation (kun FJX4233EEH/FJX4333E(EH)/FJX7333IHP/ FJX7337IHP/FJX7457IHP) på side 203).
	Aktiverer/deaktiverer kølemodus (Ventilation (kun FJX4233EEH/FJX4333E(EH)/FJX7333IHP/FJX7337IHP/ FJX7457IHP) på side 203).
	Aktiverer/deaktiverer opvarmningsmodus (Ventilation (kun FJX4233EEH/FJX4333E(EH)/FJX7333IHP/ FJX7337IHP/FJX7457IHP) på side 203).
	Indstiller ventilatorhastigheden mellem lav, middel, høj, turbo eller automatisk (vises som 1, 2, 3, 4 eller AA på luftfordelingsboksens display i kort tid, når indstillingen ændres).



















Symbol	Beskrivelse
	Aktiverer/deaktiverer ventilation (Ventilation (kun FJX4233EEH/FJX4333E(EH)/FJX7333IHP/FJX7337IHP/ FJX7457IHP) på side 203). Cirkulerer luft uden opvarmning eller køling.
	Aktiverer/deaktiverer affugtning (Ventilation (kun FJX4233EEH/FJX4333E(EH)/FJX7333IHP/FJX7337IHP/ FJX7457IHP) på side 203).

## 7.4 Fjernbetjening FreshJet FJX4233EEH/FJX4333E(EH)/FJX7333IHP/ FJX7337IHP/FJX7457IHP





Kontrol- og displayelementer fig. **4** på side 201:

Knap	Beskrivelse
—	<p><b>Display</b></p> <p>Viser følgende værdier:</p> <ul style="list-style-type: none"> <li>• Klokkeslæt</li> <li>• Valgt rumtemperatur (målværdi) i °C</li> <li>• Faktisk rumtemperatur</li> <li>• Klimaanlægsmodus</li> <li>• Ventilatorhastighed</li> <li>• Symboler for aktive ekstrafunktioner</li> <li>• Batteristatus</li> </ul>
	Tænder tagklimaanlægget eller indstiller det på standby-modus.
	Forøger den aktuelt viste værdi.
	Reducerer den aktuelt viste værdi.
	Vælger ventilatorhastigheden (Manuelt valg af ventilatorhastigheden på side 207).
	Vælger klimaanlægsmodus (Ventilation (kun FJX4233EEH/FJX4333E(EH)/FJX7333IHP/FJX7337IHP/FJX7457IHP) på side 203). Det pågældende symbol vises.
	Aktiverer sleep-funktionen (Yderligere funktioner (kun FJX4233EEH/FJX4333E(EH)/FJX7333IHP/FJX7337IHP/FJX7457IHP) på side 203). Symbolet  vises.
	Bekræfter og gemmer indstillingerne.
	Indstiller timeren og uret.
	Tænder eller slukker for omgivelseslysene i luftfordelingsboksen.
	Tryk én gang for at få vist den aktuelle indvendige temperatur. Symbolet  vises. Tryk to gange for at indstille temperaturen.
	Aktiverer I feel-funktionen. Symbolet  vises. Hvert 10 min I feel-funktionen tilpassende måltemperaturen efter den faktiske temperatur, der måles af fjernbetjeningen.
	Tænder eller slukker for omgivelseslysene i tagenheden.
	Viser, at fjernbetjeningens batterier er flade. Udskift batterierne (Udskiftning af fjernbetjeningens batterier på side 210).
	Viser, at fjernbetjeningen sender værdier til tagklimaanlægget.

## 7.5 Ventilationsmodi (kun FJX4233M)

Tagklimaanelægget har følgende klimaanelægsmoduser:

Klimaanelægsmodus	Vist symbol	Beskrivelse
Køling		Du indstiller temperaturen og ventilatorindstillingerne, og tagklimaanelægget køler det indre til denne temperatur.
Ventilation		Du indstiller ventilatorindstillinger, og tagklimaanelægget cirkulerer luft uden opvarmning eller køling.

## 7.6 Ventilation (kun FJX4233EEH/FJX4333E(EH)/FJX7333IHP/FJX7337IHP/FJX7457IHP)

Tagklimaanelægget har følgende klimaanelægsmoduser:

Klimaanelægsmodus	Vist symbol	Beskrivelse
Automatisk	<b>A</b>	Du indstiller temperaturen, og tagklimaanelægget bringer det indre til denne temperatur med opvarmning eller køling og ved om nødvendigt af kontrollere ventilatorhastigheden.
Køling		Du indstiller temperaturen og ventilatorindstillingerne, og tagklimaanelægget køler det indre til denne temperatur.
Opvarmning		<b>Ikke FJX4333E:</b> Du indstiller temperaturen og ventilatorindstillingerne, og tagklimaanelægget opvarmer det indre til denne temperatur. Ventilatoren starter kun efter 2 min (på lav hastighed), og efter cirka 5 min skifter ventilatoren til den indstillede ventilatorhastighed (efter fordampere når temperaturen).
Ventilation		Du indstiller ventilatorindstillinger, og tagklimaanelægget cirkulerer luft uden opvarmning eller køling.
Luftaffugtning		Tagklimaanelægget fjerner fugten fra luften uden af varme eller køle det indre og nedsætter dermed den relative luftfugtighed.
Luftrensere		<b>Ikke FJX4333E:</b> Tagklimaanelægget ioniserer luften og filtrerer dermed støv og partikler inklusive virusser og bakterier ud af luften.

## 7.7 Yderligere funktioner (kun FJX4233EEH/FJX4333E(EH)/FJX7333IHP/FJX7337IHP/FJX7457IHP)

Tagklimaanelægget har følgende ekstrafunktioner:

Ekstrafunktion	Displaymelding	Beskrivelse
Timer		Tagklimaanelægget tændes på det indstillede tidspunkt.

Ekstrafunktion	Displaymelding	Beskrivelse
	⌚⌚⌚⌚	Tagklimaanelægget slukkes på det indstillede tidspunkt.
	⌚⌚⌚⌚ ⌚⌚⌚⌚	Tagklimaanelægget tændes på det indstillede tidspunkt og slukkes igen.
Sleep	☾	Sleep-funktionen reducerer ventilatorhastigheden og kompressorhastigheden for at nedsætte støjniveauerne med henblik på en behagelig søvn.
I Feel	🌡️	Fjernbetjeningen måler rumtemperaturen og sender denne måling tagklimaanelægget hvert 10 min. Tagklimaanelægget tilpasser målværdien efter denne måling.
Soft start		<b>Ikke FJX4233EEH:</b> Spidsstrømmen, som kompressorens start frembringer, nedbringes af soft start-funktionen. Hvis generatoren anvendes som strømforsyning, bliver generatoren ikke overbelastet.

## 8 Før første brug

### Kontroller før ibrugtagningen

Vær opmærksom på følgende, før tagklimaanelægget tændes:

1. Kontrollér, om forsyningsspændingen og -frekvensen overholder værdierne, der er angivet i Tekniske data på side 217.
2. Kontrollér, at både luftindtagsåbningerne og luftdyserne er frie. Alle ventilationsgitre skal altid holdes fri for at sikre, at tagklimaanelægget kan køre med maksimal kapacitet.

### Forberedelse af fjernbetjeningen (kun FreshJet FJX4233EEH/FJX4333E(EH)/FJX7333IHP/FJX7337IHP/FJX7457IHP)

3. Sæt batterierne i (Udskiftning af fjernbetjeningens batterier på side 210).

### Indstil tiden (kun FreshJet FJX4233EEH/FJX4333E(EH)/FJX7333IHP/FJX7337IHP/FJX7457IHP)

4. Indstil den aktuelle tid (Indstilling af det aktuelle klokkeslæt på side 207).

## 9 Betjening

### 9.1 Tips til bedre brug

De følgende tips optimerer dit tagklimaanelægs funktion:

- Forbedr køretøjets varmeisolerings ved at tætte spalter og tildække vinduet med reflekterende rullegardiner eller forhæng.
- Vælg en passende temperatur og et passende blæsertrin.
- Indstil luftdyserne omhyggeligt.
- Kontrollér, at luftdyserne og luftindtagsåbningerne ikke er tildækket af tøj, papir eller andre genstande.

- **Kun FreshJet FJX4233EEH/FJX4333E(EH)/FJX7333IHP/FJX7337IHP/FJX7457IHP:** Hvis køretøjet har været udsat for direkte sollys i lang tid: Betjen tagklima anlægget i modusen Ventilation (☼) med åbne vinduer i et stykke tid, før du skifter til modusen Køling (❄️).
- **Kun FreshJet FJX4233EEH/FJX4333E(EH)/FJX7333IHP/FJX7337IHP/FJX7457IHP:** Undgå så vidt muligt at åbne døre og vinduer i modusen Køling (❄️).

## 9.2 Grundlæggende henvisninger til betjeningen

FreshJet FJX4233M tagklima anlægget har tre driftsmoduser:

Driftsmodus	Beskrivelse
Slukket	Tagklima anlægget er slukket.
Køling	Tagklima anlægget køler kabinen.
Ventilation	Tagklima anlægget cirkulerer uden køling.

FreshJet FJX4233EEH/FJX4333E(EH)/FJX7333IHP/FJX7337IHP/FJX7457IHP tagklima anlægget har to driftsmoduser:

Driftsmodus	Beskrivelse
Standby	Tagklima anlægget er driftsklart og kan tændes med fjernbetjeningen. Omgivelseslysene står til rådighed. Fjernbetjeningen er også på standby, men du kan tænde for fjernbetjeningen uafhængigt af tagklima anlægget.
Tændt	Tagklima anlægget klimatiserer luften i det indre.

## 9.3 Dometic FJX4233M

De pågældende oplysninger i dette kapitel gælder kun for FJX4233M tagklima anlæg.

### 9.3.1 Sådan tændes og slukkes tagklima anlægget

Tagklima anlægget har to klima anlægsmodi:





- Ventilationsmodus (☼)
- Kølemodus (❄️)



**Bemærk** Før du skifter fra ventilationsmodus til kølemodus eller omvendt skal du vente i mindst 30 s. Ellers kan skiftestrømmen sprænge sikringen.

Hver modus har tre indstillinger:

- ..: Lav
- ...: Middel
- ...: Høj

- > For at tænde skal knappen  drejes hen på positionen for ventilationsmodus () eller positionen for kølemodus (), og man derefter vælger den ønskede indstilling.
- ✓ Tagklima anlægget tændes og kører med de indstillede værdier, før der slukkes.
- > For at slukke skal du dreje knappen  hen på positionen 0.

### 9.3.2 Indstilling af temperaturen

- > Drej knappen  hen på den ønskede position. Hvis knappen drejes med uret, bliver temperaturen koldere.
- ✓ Temperaturen er indstillet i tagklima anlægget.

## 9.4 FreshJet FJX4233EEH/FJX4333E(EH)/FJX7333IHP/FJX7337IHP/FJX7457IHP

De pågældende oplysninger i dette kapitel gælder kun for FreshJet FJX4233EEH/FJX4333E(EH)/FJX7333IHP/FJX7337IHP/FJX7457IHP tagklima anlæg.

### 9.4.1 Med fjernbetjeningen



Vær opmærksom på følgende tips, når du bruger fjernbetjeningen:

- Ret fjernbetjeningen mod kontrolpanelets IR-modtager.
- De pågældende indstillinger sendes direkte til tagklima anlægget, når du trykker på en knap.
- Tagklima anlægget bekræfter modtagelsen af dataene med en biplyd.
- Værdierne forøges eller reduceres hurtigere, hvis du trykker på knappen + eller – og holder den inde.
- På standbytilstand er fjernbetjeningens display også inaktivt. Du kan indstille fjernbetjeningen på standby uafhængigt af tagklima anlægget.
- > For kun at tænde for fjernbetjeningen eller indstille den på standby skal du trykke på knappen , mens den ikke er rettet mod kontrolpanelets IR-modtager.

### 9.4.2 Sådan sættes tagklima anlægget på standby



**Bemærk** Når tagklima anlægget tændes, kører det med de værdier, der blev indstillet, før der blev skiftet til standby. Tagklima anlægget kan slukkes ved at afbryde strømforsyningen.





- > Tryk på knappen  på fjernbetjeningen eller på knappen  på kontrolpanelet for at tænde for tagklima anlægget eller indstille det på standby.



### 9.4.3 Valg af klimamodus

- > Vælg den ønskede klimaanlægsmodus med knappen MODE (Ventilation (kun FJX4233EEH/FJX4333E(EH)/FJX7333IHP/FJX7337IHP/FJX7457IHP) på side 203).
- ✓ Tagklima anlægget bekræfter modtagelsen af værdierne med en biplyd. Tagklima anlægget indstilles på den valgte klimaanlægsmodus.

### 9.4.4 Manuelt valg af ventilatorhastigheden

På alle modi bortset fra den automatiske (A) og Affugtning (☉) kan ventilatorhastigheden vælges manuelt.

Displaymelding	Beskrivelse
	Lavt ventilatortrin
	Mellem ventilatortrin
	Højt ventilatortrin.
	Turbo ventilatortrin.
	Automatisk modus (ventilatorhastigheden tilpasses efter udenomstemperaturen).

- > Tryk på knappen  på fjernbetjeningen eller på knappen  på kontrolpanelet for at vælge den ønskede ventilatorhastighed.
  - ✓ Tagklimaanelægget bekræfter modtagelsen af værdierne med en biplyd.
- Den ny blæserhastighed er indstillet.

### 9.4.5 Indstilling af temperaturen

På modiene Automatisk (A), Køling (❄), Opvarmning (☀) og Affugtning (☉) kan du indstille en temperatur på mellem 16 °C og 31 °C.

- > Brug knappen + eller – på fjernbetjeningen for at indstille den ønskede temperatur.
- ✓ Tagklimaanelægget bekræfter modtagelsen af værdierne med en høj tone. Temperaturen er indstillet i tagklimaanelægget.

### 9.4.6 Indstilling af det aktuelle klokkeslæt

Fjernbetjeningen skal kende det aktuelle klokkeslæt ved timerprogrammeringen. Klokkeslættet vises på fjernbetjeningens display.

1. Tryk på knappen  og hold den inde for at åbne modusen for indstillingen klokkeslættet.
- ✓ Klokkeslættet blinker på fjernbetjeningens display.
2. Brug knapperne + eller – for at indstille det aktuelle klokkeslæt. Tryk på knappen + eller – i over 2 s for at forøge eller reducere klokkeslættet hurtigere.
3. Tryk på tasten SET for at bekræfte klokkeslættet.

### 9.4.7 Indstilling af timeren

Med timerfunktionen kan du indstille et ønsket tidsrum for klimatiseringen. Du kan indstille en aktiveringstid, en tid for standby eller begge værdier.

Timer-funktionen indstilles via fjernbetjeningen.



**Bemærk** Fjernbetjeningen går tilbage på dens oprindelige modus, hvis der ikke trykkes på nogen knap i 15 s, mens timeren programmeres.

- > Indstil **aktiveringstimeren** på følgende måde:
  - a) Vælg den ønskede ventilation og alle krævede værdier (f.eks. temperaturen).
  - b) Indstil om nødvendigt tagklimaanelægget på standby.  
Aktiveringstimeren kan kun indstilles, når tagklimaanelægget er på **standby**.
  - c) Tryk én gang på knappen .
  - ✓ Symbolet blinker på fjernbetjeningens display.
  - d) Brug knapperne + eller – for at indstille tiden for, hvornår tagklimaanelægget skal tændes.
  - e) Tryk på knappen .

Aktiveringstimeren er indstillet. Tagklimaanelægget tændes med den valgte ventilation på den indstillede tid.

- > Indstil **tiden for standby** på følgende:
  - a) Tænd om nødvendigt for tagklimaanelægget.  
Timeren for standby kan kun indstilles, når tagklimaanelægget er **tændt**.
  - b) Tryk på knappen to gange.
  - ✓ Symbolet blinker på fjernbetjeningens display.
  - c) Brug + eller – knappen for at indstille tiden for, hvornår tagklimaanelægget skal indstilles på standby.
  - d) Tryk på knappen .

Timeren for standby er indstillet. Tagklimaanelægget indstilles på standby på det indstillede tidspunkt.

- > Indstil **aktiveringstimeren** og **timeren for standby** på følgende måde:
  - a) Vælg den ønskede ventilation og alle krævede værdier (f.eks. temperaturen).
  - b) Tryk på knappen tre gange.
  - ✓ Symbolet vises på fjernbetjeningens display. ON-symbolet blinker.
  - c) Brug knapperne + eller – for at indstille tiden for, hvornår tagklimaanelægget skal tændes.
  - d) Tryk på knappen .
  - ✓ Symbolet **OFF** blinker.
  - e) Brug + eller – knappen for at indstille tiden for, hvornår tagklimaanelægget skal indstilles på standby.
  - f) Tryk på knappen .

✓ Tiderne for aktivering og standby er indstillet. Tagklimaanelægget tændes i den indstillede tidsperiode.

  - > For at **annullere** den indstillede timer skal du trykke på én gang på knappen .
  - ✓ Symbolerne forsvinder. De forindstillede værdier kasseres.







### 9.4.8 Indstilling af sleep-funktionen

Sleep-funktionen findes kun i modiene Køling (❄️) eller Opvarmning (☀️).

Sleep-funktionen ventilatorhastigheden til et lavere trin for at reducere støjniveauerne for bedre at kunne sove.

**Kun FJX7333IHP/FJX7337IHP/FJX7457IHP:** Sleep-funktionen begrænser desuden kompressorhastigheden.



- > Gør følgende for at aktivere sleep-funktionen:
  - a) Indstil den krævede temperatur (Indstilling af temperaturen på side 207).
  - b) Tryk på knappen  på fjernbetjeningen eller på knappen  på kontrolpanelet.
- ✓ Symbolet  vises på fjernbetjeningens display. Sleep-funktionen er aktiveret.
  - > For at deaktivere sleep-funktionen skal der trykkes på  eller knappen  på fjernbetjeningen eller knappen  på kontrolpanelet.
- ✓ Symbolet  forsvinder fra fjernbetjeningens display. sleep-funktionen er deaktiveret.

### 9.4.9 Aktivering af I feel-funktionen

Når denne funktion er aktiv, måler fjernbetjeningen rumtemperaturen og sender denne måling hvert 10. minut til tagklima anlægget. Tagklima anlægget tilpasser målværdien efter denne måling. I feel-funktionen er kun aktiv, når temperaturen ligger mellem +18 °C og +29 °C.

Fjernbetjeningen må ikke befinde sig i et område af rummet, der er væsentligt varmere eller koldere end den gennemsnitlige rumtemperatur. Den må f.eks. ikke ligge i solen eller foran tagklima anlægget.

Hvis temperaturen stiger til over +29 °C eller falder til under +18 °C, deaktiveres I feel-funktionen. Symbolet  blinker tre gange på displayet og slukker derefter.

1. Tryk på knappen.
- ✓ I feel-funktionen er aktiveret.

Symbolet  vises på displayet.

2. Anbring fjernbetjeningen, så den peger på den infrarøde modtager på kontrolpanelet. Ellers kan værdierne ikke sendes til tagklima anlægget.







### 9.4.10 Betjening af omgivelseslysene



**ADVARSEL! Fare for kvæstelser** Loven forbyder at bruge eksternt lys, når køretøjet køres.

Knappen  på fjernbetjeningen er aktiv, selv hvis fjernbetjeningen er slukket.

#### Kun FreshJet FJX4233EEH/FJX4333E(EH)/FJX7333IHP/FJX7337IHP/FJX7457IHP:

- > For at tænde eller slukke for det indvendige lys skal du trykke på knappen  på fjernbetjeningen eller på kontrolpanelet.
- ✓ Symbolet  blinker én gang på displayet på fjernbetjeningen, når det indvendige lys er **tændte**.
  - > Gør følgende for at dæmpe det indvendige lys:
    - a) Tryk på knappen  på fjernbetjeningen eller på kontrolpanelet i 3 s.
    - b) Når der trykkes på knappen  på fjernbetjeningen: Tryk på knappen  for at dæmpe det indvendige lys mellem 50 % og 100 %.
    - c) Når der trykkes på knappen  på kontrolpanelet: Lysstyrkecyklusserne for indvendige lys mellem 50 % og 100 %. Slip knappen , når den ønskede lysstyrke er nået.

#### Kun FreshJet FJX7333IHP/FJX7337IHP/FJX7457IHP:

- > For at tænde eller slukke for det eksterne lys skal du trykke på knappen  på kontrolpanelet.

## 9.4.11 Udskiftning af fjernbetjeningens batterier



**Bemærk** Fjernbetjeningens display kan fortsat være lyst, selv om batterierne er ved at være flade. Udskift batterierne, når fjernbetjening viser næsten flade batterier.

- > Udskift batterierne som vist.

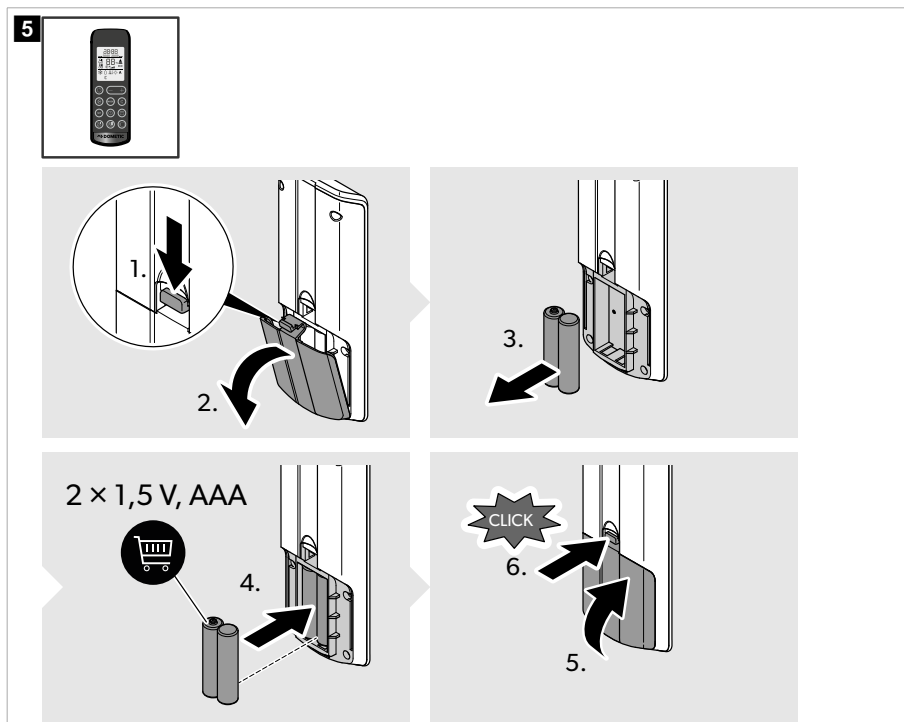

- ✓ Displayet viser alle symboler for 5 s.



Beskyt miljøet! Genopladelige og ikke-genopladelige batterier hører ikke til i husholdningsaffaldet. Aflever defekte genopladelige batterier og brugte batterier hos forhandleren eller på et indsamlingssted.

## 9.5 Regulering af luftforsyningen i køretøjet

Luftstrømmen kan indstilles langs loftet eller mod gulvet.

- > Drej lamellerne i luftdyserne uafhængigt i de krævede retninger.

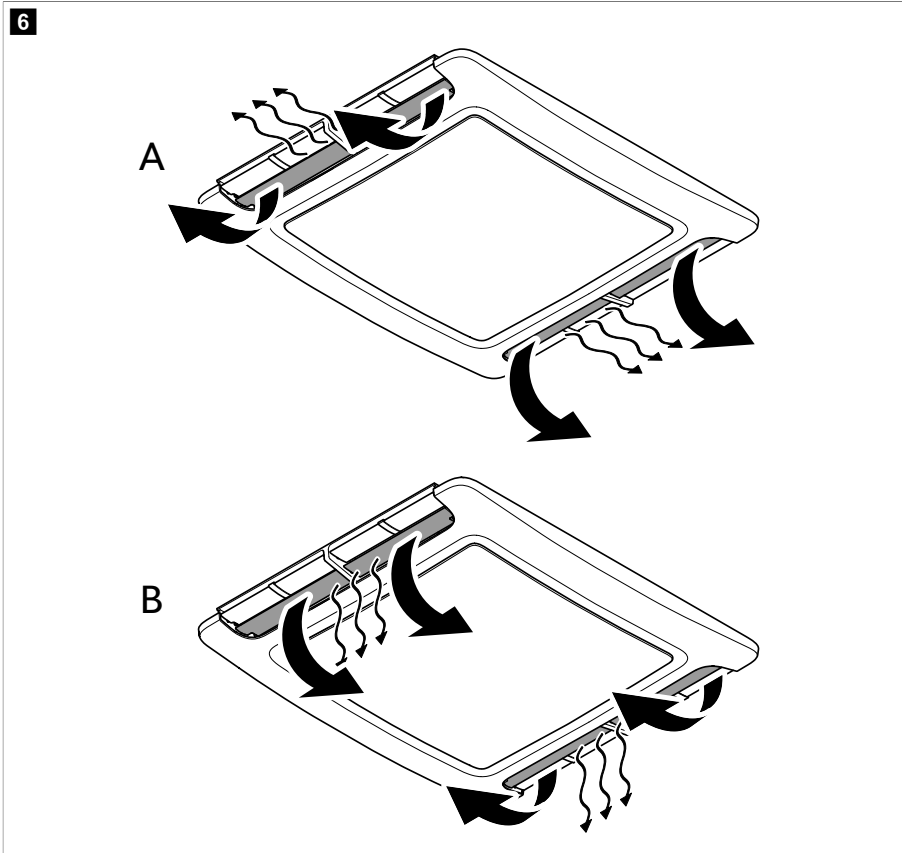

## 10 Rengøring af tagklimaanelægget



### VIGTIGT! Fare for beskadigelse

- Du må ikke benytte andre tiltag til at accelerere afrymningsprocessen eller til rengøring bortset fra dem, der anbefales af producenten.
- Rengør ikke klimaanelægget til tagmontering med en højtryksrenser. Indtrængende vand kan beskadige klimaanelægget til tagmontering.
- Anvend ikke skarpe eller hårde genstande eller rengøringsmidler til rengøring, da det kan beskadige tagklimaanelægget.
- Der må ikke anvendes benzin, diesel eller opløsningsmidler.

1. Fjern regelmæssigt blade og andet snavs fra luftindtaget og ventilationsgitrene til tagklimaanelægget. Du må ikke beskadige ventilationsgitrene under processen.

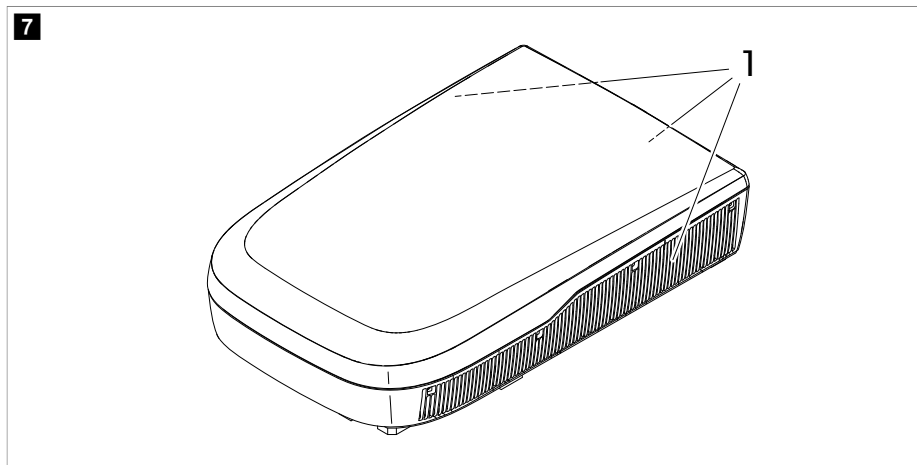

2. Rengør af og til husene til tagenheden og luftfordelingsboksen med en fugtig klud. Brug kun vand med et mildt rengøringsmiddel.
3. **Kun FreshJet FJX4233EEH/FJX4333E(EH)/FJX7333IHP/FJX7337IHP/FJX7457IHP:** Rengør af og til fjernbetjeningen med en let fugtig klud. Rengør displayet med en rengøringsklud til briller.
4. **Kun FreshJet FJX4233EEH/FJX4333E(EH)/FJX7333IHP/FJX7337IHP/FJX7457IHP** Rengør af og til luftfordelingsboksens display med en mild opløsning af lunke sæbevand. Displayskærmen består af akryl og kan blive beskadiget af enkelte almindelige kemikalier som f.eks. kemiske rengøringsmidler, vinduesrens, alkohol, bestemte tensider, organiske opløsningsmidler og blødgørere.

## 11 Vedligeholdelse

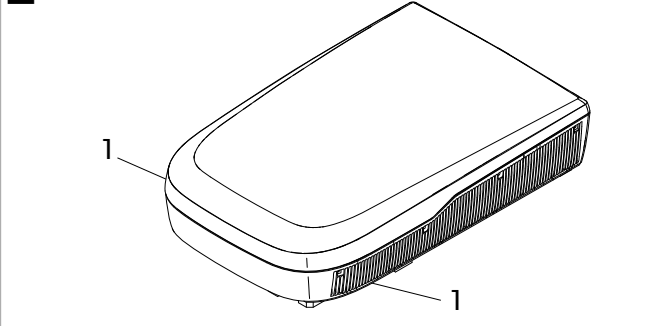
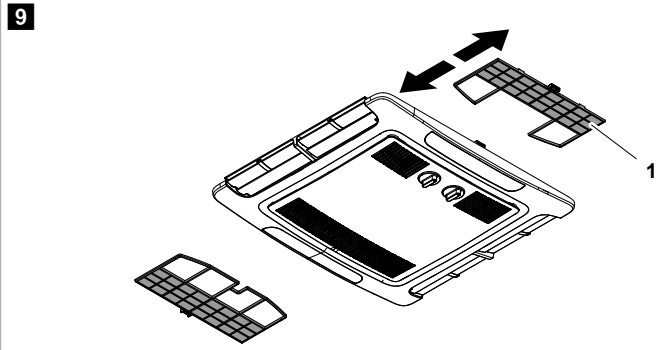

**ADVARSEL! Fare for kvæstelser** Andre vedligeholdelsesarbejder ud over dem, der er beskrevet her, må kun foretages af agfolk, der kender farerne ved håndtering af kølemidler og klimaanelæg og de pågældende forskrifter.

Interval	Kontrol/vedligeholdelse
Regelmæssig	<p data-bbox="333 188 1014 231">Kontrollér, hvorvidt kondensvandets afløbskanaler (1) på siderne af tagklimaenlægget er rene, og at kondensvandet kan løbe ud.</p> <div data-bbox="333 247 1014 616"><p data-bbox="344 256 367 284"><b>8</b></p></div>
Regelmæssigt (Freshjet FJX4233M)	<p data-bbox="333 643 658 663">Rengør filteret på luftudstrømningsheden.</p> <div data-bbox="333 679 1014 1046"><p data-bbox="344 689 367 716"><b>9</b></p></div> <ol data-bbox="348 1062 893 1126" style="list-style-type: none"><li>1. Fjern filteret (1).</li><li>2. Rengør filteret (1) med en rengøringsmiddelopløsning, og lad det tørre.</li><li>3. Sæt det tørre filter (1) i igen.</li></ol>

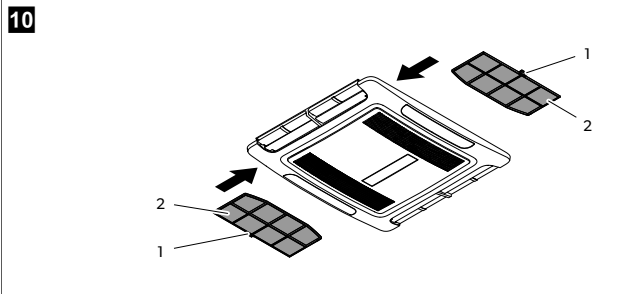
Interval	Kontrol/vedligeholdelse
Regelmæssigt (Fresh-Jet FJX4233EEH/ FJX4333E(EH)/FJX7333IHP/ FJX7337IHP/FJX7457IHP)	<ul style="list-style-type: none"> <li>Rengør filteret på luftudstrømningsenheden.</li> </ul> <div data-bbox="367 225 1016 528" style="border: 1px solid black; padding: 10px; margin: 10px 0;">  </div> <ol style="list-style-type: none"> <li>Sæt en flad skruetrækker eller kniv ind i grebet (1) for at trække filterne (2) lidt ud.</li> <li>Fjern filterne manuelt.</li> <li>Rengør filterne med en rengøringsmiddelopløsning, og lad dem tørre.</li> <li>Skub de tørre filtre ind igen. fig. 10 på side 214</li> </ol> <ul style="list-style-type: none"> <li>Lad et specialfirma vedligeholde varmeveksleren i tagklima anlægget.</li> </ul>
En gang om året	<ul style="list-style-type: none"> <li>Kontrollér tætningerne mellem tagklima anlægget og køretøjets tag for revner og andre skader.</li> <li>Kontrollér, om fastgørelsesboltene er spændt med det rigtige tilspændingsmoment (2.5 Nm ± 0.3 Nm), og justér om nødvendigt.</li> </ul>

## 12 Udbedring af fejl

Fejl	Mulig årsag	Løsningsforslag
Køler ikke nok	Tagklima anlægget er ikke indstillet på køling.	Indstil tagklima anlægget på køling.
	Udenomstemperaturen er højere end 52 °C.	Tagklima anlægget er kun beregnet til en udenomstemperatur op til 52 °C.
	Den indstillede temperatur er højere end rumtemperaturen.	Vælg en lavere temperatur.
	Udenomstemperaturen er under 16 °C.	Tagklima anlægget er kun beregnet til køling ved udenomstemperaturer over 16 °C.
	En af temperaturfølerne er defekt.	Kontakt en autoriseret serviceforhandler eller Dometic.
	Fordamperblæseren er beskadiget.	Kontakt en autoriseret serviceforhandler eller Dometic.
	Kondensatorblæseren er beskadiget.	Kontakt en autoriseret serviceforhandler eller Dometic.

Fejl	Mulig årsag	Løsningsforslag
<b>Kun FreshJet FJX4233EEH/ FJX4333E(EH)/FJX7333IHP/ FJX7337IHP/FJX7457IHP:</b> Opvarmer ikke nok	Tagklima-lægget er ikke indstillet på opvarmning.	Indstil tagklima-lægget på opvarmning.
	Udenomstemperaturen er under $-2\text{ }^{\circ}\text{C}$ .	Tagklima-lægget er beregnet til køling ved udenomstemperaturer over $-2\text{ }^{\circ}\text{C}$ .
	Den indstillede temperatur er lavere end rumtemperaturen.	Vælg en højere temperatur.
	En af temperaturfølerne er defekt.	Kontakt en autoriseret serviceforhandler eller Dometic.
	Fordamperblæseren er beskadiget.	Kontakt en autoriseret serviceforhandler eller Dometic.
Lav luftudstrømning	Luftindtagsåbningerne er blokerede eller forhindrede.	Fjern alle blade og anden snavs fra ventilationsgitrene på tagklima-lægget.
	Blæseren er defekt.	Kontakt en autoriseret serviceforhandler eller Dometic.
Der trænger vand ind i køretøjet	Afløbsåbningerne til kondensvand er tilstoppede.	Rengør vandafløbsåbningerne for kondensvand.
	Tætningerne er beskadigede.	Kontakt en autoriseret serviceforhandler eller Dometic.
Tagklima-lægget tænder ikke.	Der er ikke tilsluttet strømforsyning.	Kontrollér strømforsyningen.
	Spændingen er for lav ( $< 200\text{ V}$ ).	Kontakt en autoriseret serviceforhandler eller Dometic.
	Spændingstransformeren er defekt.	Kontakt en autoriseret serviceforhandler eller Dometic.
	En af temperaturfølerne er defekt.	Kontakt en autoriseret serviceforhandler eller Dometic.
	Strømforsyningens elektriske sikring er for lav.	Kontakt en autoriseret serviceforhandler eller Dometic.
Tagklima-lægget slukker ikke.	En af temperaturfølerne er defekt.	Kontakt en autoriseret serviceforhandler eller Dometic.
	Strømforsyningens elektriske sikring er for lav.	Kontakt en autoriseret serviceforhandler eller Dometic.
<b>Kun FreshJet FJX4233EEH/ FJX4333E(EH)/FJX7333IHP/ FJX7337IHP/FJX7457IHP:</b> Tagklima-lægget slukker hele tiden af sig selv.	Tilslutningssensoren har udløst.	Udetemperaturen er for lav, eller alle luftdyser er lukkede.
Displayet viser: PO	Overtemperatur eller overstrøm på IPM-modul	Kontakt en autoriseret serviceforhandler eller Dometic.

Fejl	Mulig årsag	Løsningsforslag
Displayet viser: P1	Underspændingsbeskyttelse	Kontakt en autoriseret serviceforhandler eller Dometic.
Displayet viser: P2	Enhed AC-overstrømsbeskyttelse	Kontakt en autoriseret serviceforhandler eller Dometic.
Displayet viser: P4	Overophedningsbeskyttelse udledningsrør	Kontakt en autoriseret serviceforhandler eller Dometic.
Displayet viser: P5	Beskyttelse fordamperspole (kølemodus)	Kontakt en autoriseret serviceforhandler eller Dometic.
Displayet viser: P6	Beskyttelse kondensatorspole (kølemodus)	Kontakt en autoriseret serviceforhandler eller Dometic.
Displayet viser: P7	Beskyttelse fordamperspole (varmemodus)	Kontakt en autoriseret serviceforhandler eller Dometic.
Displayet viser: P9	Kompressordrev unormalt eller kompressoren starter ikke	Kontakt en autoriseret serviceforhandler eller Dometic.
Displayet viser: E0	Kommunikationsfejl	Kontakt en autoriseret serviceforhandler eller Dometic.
Displayet viser: E1	Fejl i rumtemperaturføler	Kontakt en autoriseret serviceforhandler eller Dometic.
Displayet viser: E2	Fejl i fordamperspolens temperatursøler	Kontakt en autoriseret serviceforhandler eller Dometic.
Displayet viser: E3	Fejl i kondensatorspolens temperatursøler	Kontakt en autoriseret serviceforhandler eller Dometic.
Displayet viser: E7	Fejl i udetemperaturføler	Kontakt en autoriseret serviceforhandler eller Dometic.
Displayet viser: E8	Fejl i temperaturføler for udledningsrør	Kontakt en autoriseret serviceforhandler eller Dometic.
Displayet viser: E9	Fejl i kompressordrev eller IPM-modul	Kontakt en autoriseret serviceforhandler eller Dometic.
Displayet viser: EA	Fejl i strømsensor	Kontakt en autoriseret serviceforhandler eller Dometic.
Displayet viser: EE	Fejl i ude-EEPROM	Kontakt en autoriseret serviceforhandler eller Dometic.
Displayet viser: EL	LIN-BUS/CI-BUS-kommunikationsfejl	Kontakt en autoriseret serviceforhandler eller Dometic.



## 13 Bortskaffelse



Bortskaf så vidt muligt emballagen i affaldscontainerne til den pågældende type genbrugsaffald. Kontakt en lokal genbrugsstation eller din faghandel for at få de pågældende forskrifter om, hvordan du bortskaffer produktet i overensstemmelse med disse gældende forskrifter for bortskaffelse.



Beskyt miljøet! Genopladelige og ikke-genopladelige batterier hører ikke til i husholdningsaffaldet. Aflever defekte genopladelige batterier og brugte batterier hos forhandleren eller på et indsamlingssted.

## 14 Garanti

Den lovbestemte garantiperiode gælder. Hvis produktet er defekt, skal du kontakte producentens afdeling i dit land (se [dometic.com/dealer](http://dometic.com/dealer)) eller din forhandler.

Ved reparation eller krav om garanti skal du medsende følgende bilag:

- en kopi af regningen med købsdato
- en reklameringsgrund eller en fejlbeskrivelse.

Vær opmærksom på, at egne eller uprofessionelle reparationer kan have sikkerhedsmæssige konsekvenser og kan gøre garantien ugyldig.

## 15 Tekniske data

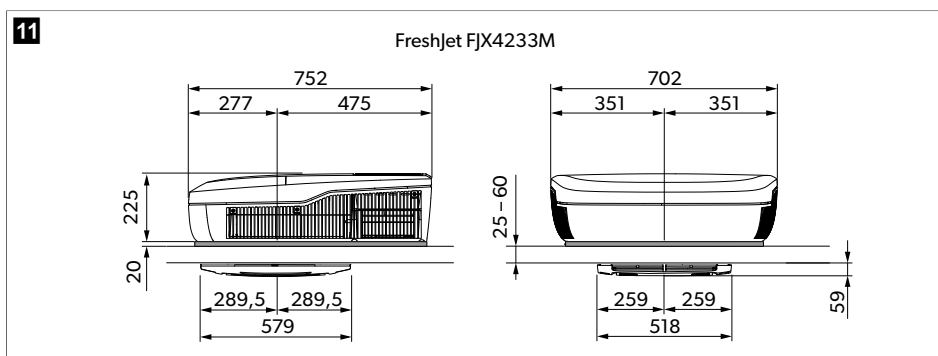

12

FJX4233EEH, FJX4333E(EH), FJX7333IHP

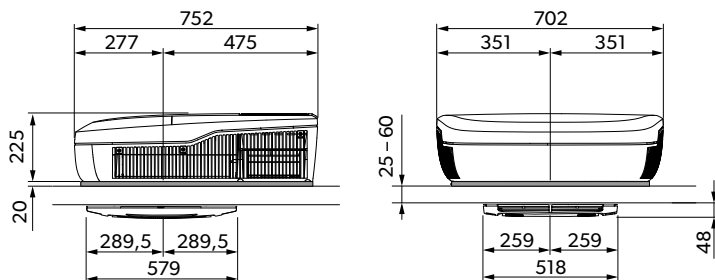

13

FreshJet FJX7337IHP

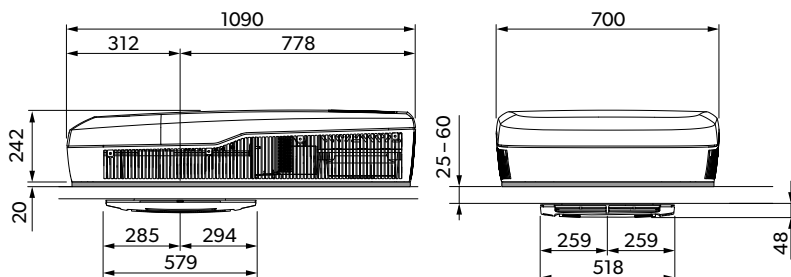

14

FreshJet FJX7457IHP

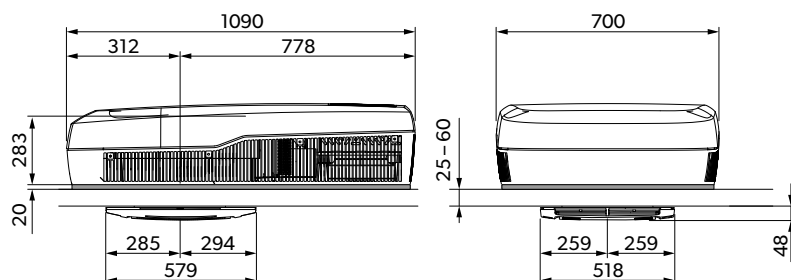

Indeholder fluorerede drivhusgasser. Hermetisk tætnet udstyr.

	<b>FreshJet FJX4233M</b>
Kølekapacitet i henhold til ISO 5151:	1500 W
AC-indgangsspænding:	220 V ... 240 V / 50 Hz

	<b>FreshJet FJX4233M</b>
Mærkestrøm køling:	< 3.3 A
Påkrævet sikring:	4 A
Driftstemperaturområde:	- 2 °C ... 52 °C
Kølemiddel:	R410a
Kølemiddelmængde:	380 g
CO <sub>2</sub> -ækvivalent:	0.793 t
Drivhuspotentiale (GWP):	2088
Kapslingsklasse (tagenhed):	IPX4
Lydniveau (højeste ventilatorindstilling)	< 70 dB(A)
Foreslået maks. køretøjslængde (med isolerede vægge):	< 5 m
Mål L x B x H:	fig. 11 på side 217
Vægt:	< 30 kg
Godkendelse/certifikat:	

	<b>FreshJet FJX4233EEH</b>	<b>FreshJet FJX4333EEH</b>	<b>FreshJet FJX4333E</b>
Kølekapacitet i henhold til ISO 5151:	1700 W	2200 W	2200 W
Varmekapacitet i henhold til ISO 5151:	800 W	1000 W	-
AC-indgangsspænding:	220 V ... 240 V / 50 Hz		
Mærkestrøm køling:	3.6 A	4.8 A	4.8 A
Mærkestrøm opvarmning:	< 5.2 A	< 5.2 A	-
Påkrævet sikring:	4 A	5 A	6 A
Driftstemperaturområde:	- 2 °C ... 52 °C		
Kølemiddel:	R32		
Kølemiddelmængde:	320 g	360 g	360 g
CO <sub>2</sub> -ækvivalent:	0.216 t	0.243 t	0.243 t

	FreshJet FJX4233EEH	FreshJet FJX4333EEH	FreshJet FJX4333E
Drivhuspotentiale (GWP):		675	
Kapslingsklasse (tagenhed):		IPX4	
Lydniveau (højeste ventilatorindstilling)		< 70 dB(A)	
Foreslået maks. køretøjslængde (med isolerede vægge):	< 6 m	< 7 m	< 7 m
Mål L x B x H:	fig. 12 på side 218		
Vægt:	< 30 kg	< 30 kg	< 30 kg
Godkendelse/certifikat:			

	FreshJet FJX7333IHP	FreshJet FJX7337IHP	FreshJet FJX7457IHP
Kølekapacitet i henhold til ISO 5151:	2200 W	3000 W	3500 W
Varmekapacitet i henhold til ISO 5151:	2000 W	2500 W	3000 W
AC-indgangsspænding:	220 V ... 240 V / 50 Hz ... 60 Hz	220 V ... 240 V / 50 Hz ... 60 Hz	220 V ... 240 V / 50 Hz ... 60 Hz
Mærkestrøm køling:	< 7.5 A	< 7.5 A	< 7.5 A
Mærkestrøm opvarmning:	< 6.1 A	< 6.1 A	< 6.1 A
Påkrævet sikring:	6 A	6 A	6 A
Driftstemperaturområde:	- 2 °C ... 52 °C	- 2 °C ... 52 °C	- 2 °C ... 52 °C
Kølemiddel:	R32	R32	R32
Kølemiddelmængde:	420 g	480 g	650 g
CO <sub>2</sub> ækvivalent:	0.2835 t	0.3240 t	0.43875 t
Drivhuspotentiale (GWP):		675	
Kapslingsklasse (tagenhed):		IPX4	
Lydniveau (højeste ventilatorindstilling)		< 70 dB(A)	
Foreslået maks. køretøjslængde (med isolerede vægge):	< 7 m	< 7 m	> 8 m

	<b>FreshJet FJX7333IHP</b>	<b>FreshJet FJX7337IHP</b>	<b>FreshJet FJX7457IHP</b>
Mål L x B x H:	fig. <b>12</b> på side 218	fig. <b>13</b> på side 218	fig. <b>14</b> på side 218
Vægt:	< 30 kg	< 35 kg	< 40 kg
Godkendelse/certifikat:			

## Swedish

1	Important notes.....	222
2	Förklaring av symboler.....	222
3	Säkerhetsanvisningar.....	223
4	Avsedd användning.....	224
5	Förklaringar av symboler på apparaten.....	225
6	Tekniska gränser och förutsättningar.....	225
7	Teknisk beskrivning.....	225
8	Före den första användningen.....	231
9	Användning.....	231
10	Rengöra takmonterad klimatanläggning.....	239
11	Underhåll.....	239
12	Felsökning.....	241
13	Avfallshantering.....	244
14	Garanti.....	244
15	Tekniska data.....	244

## 1 Important notes

Läs och följ noggrant alla instruktioner, direktiv och varningar i den här produkthandboken för att säkerställa att du alltid installerar, använder och underhåller produkten på rätt sätt. Dessa instruktioner MÅSTE förvaras tillsammans med produkten.

Genom att använda produkten bekräftar du härmed att du noggrant har läst alla instruktioner, direktiv och varningar och att du förstår och är införstådd med att följa de villkor som anges här. Du är införstådd med att endast använda denna produkt i avsett syfte och i enlighet med instruktionerna, direktiven och varningarna som anges i denna produkthandbok samt i enlighet med alla gällande lagar och bestämmelser. Om du inte läser och följer instruktionerna och varningarna som anges här kan det leda till personskador på dig eller andra, på produkten eller annan egendom i närheten. Denna produkthandbok, inklusive instruktionerna, direktiven och varningarna samt relaterad information, kan ändras och uppdateras. För uppdaterad produktinformation, besök [documents.dometic.com](http://documents.dometic.com).

## 2 Förklaring av symboler



**FARA!** Anger en farlig situation som, om den inte kan undvikas, leder till döden eller allvarlig personskada.



**WARNING!** Anger en farlig situation som, om den inte kan undvikas, leder till döden eller allvarlig personskada.



**AKTA!** Anger en farlig situation som, om den inte kan undvikas, leder till lindrig eller måttlig personskada.



**OBSERVERA!** Anger en farlig situation som, om den inte kan undvikas, leder lindrig eller måttlig personskada.



**Anvisning** Kompletterande information om användning av produkten.

### 3 Säkerhetsanvisningar



**VARNING! Om man underlåter att följa de här varningarna kan följden bli dödsfall eller allvarlig personskada.**

- **Elektriska apparater är inga leksaker.** Apparaten ska inte användas av personer (inklusive barn) med nedsatt fysisk, sensorisk eller mental förmåga eller med bristande erfarenheter och kunskaper såvida de inte är under uppsikt eller har fått anvisningar.
- Barn måste hållas under uppsikt så att de inte leker med apparaten.
- Barn från åtta års ålder, personer med nedsatt fysisk, sensorisk eller mental förmåga, eller personer med bristande erfarenhet och kunskaper får använda den här anordningen förutsatt att de hålls under uppsikt eller om de har fått anvisningar om hur man använder den här anordningen på ett säkert sätt och känner till vilka risker som är förknippade med användningen.
- Barn får inte utföra rengöringsarbeten utan uppsikt.
- Alla personer som arbetar med eller bryter ett kylkretslopp ska ha ett giltigt och aktuellt certifikat från ansvarig myndighet, vilket befullmäktigar deras kompetens att hantera kylmedium säkert enligt gällande specifikationer och bestämmelser inom industrin.
- Underhåll ska endast utföras enligt rekommendationerna från tillverkaren. Underhåll och reparationer som kräver assistans från annan kvalificerad personal ska utföras under övervakning av personen som är ansvarig för användning av antändbara kylmedium.
- Reparation får endast genomföras av härför utbildad personal, som är förtrogen med de förbundna farorna och de gällande föreskrifterna. Icke fackmässiga reparationer kan medföra allvarliga risker. För reparationservice, kontakta servicecenter i ditt land (se [dometic.com/dealer](http://dometic.com/dealer)).
- Koppla alltid bort spänningskällan före arbeten på apparaten.
- Apparaten ska förvaras i utrymmen utan konstant brinnande antändningskällor, t.ex. öppna lågor, en gasanordning under drift eller elektriska värmare under drift.
- Stick inte hål i eller bränn apparaten.
- Tänk på att kylmedel kanske inte luktar något.
- Använd inte apparaten i närheten av antändliga vätskor eller i slutna utrymmen.
- Se till att inga brännbara föremål är monterade eller finns i närheten av luftutsläppet. Avståndet måste vara minst 50 cm.
- Håll ventilationsöppningarna fria från hindrande föremål.
- Skada inte kylkretsen.
- Under inga omständigheter ska potentiella antändningskällor användas när du letar efter läckor i kylmedelskretsen. En gasbrännare (eller liknande apparater med öppen flamma) får inte användas.
- Den takmonterade klimatanläggningen ska installeras i ett fordon med golv större än 4 m<sup>2</sup>.



### **AKTA! Om man underlåter att följa de här försiktighetsåtgärderna kan följden bli lindrig eller måttlig personskada.**

- Stick inte in händerna i ventilationsöppningarna, stick inte in några främmande föremål i apparaten.
- Öppna inte den övre kåpan apparaten om en brand skulle bryta ut. Använd i stället godkända släckningsmedel. Använd inte vatten för att släcka elden.
- Om elsladden är skadad måste den, av säkerhetsskäl, bytas ut av tillverkaren, tillverkarens kundtjänst eller annan behörig person.
- Om du har en sjukdom och apparaten innehåller en joniserare bör du kontakta din läkare. Joniseraren kan producera ozon (O<sub>3</sub>) i små mängder. Om du lider av lungsjukdom, astma, hjärtsjukdom, luftvägssjukdom har luftvägsproblem eller är känslig mot ozon bör du kontakta din läkare för att bestämma om det är säkert för dig att använda av denna apparat.



### **OBSERVERA! Risk för skada**

- Använd inga medel för att påskynda avfrostningsprocessen eller för att rengöra, utöver de som tillverkaren rekommenderar.
- Apparaten ska förvaras så att mekanisk skada undviks.
- Gör inga ändringar eller ombyggnader på apparaten!
- Kör aldrig genom en biltvättanläggning om en klimatanläggning har monterats på husbilens tak.
- Om fel inträffar i kylkretsloppet måste apparaten kontrolleras eller repareras av tillverkaren, tillverkarens servicerepresentant eller liknande kvalificerad personal.

## **4 Avsedd användning**

Den takmonterade klimatanläggningen FreshJet FJX är endast avsedd för installation på ett tak på en husvagn eller husbil för kylning.

Den takmonterade klimatanläggningen är **inte** lämplig för tåg, hus och lägenheter. Den takmonterade klimatanläggningen är **inte** lämplig för byggmaskiner, jordbruksmaskiner eller andra arbetsmaskiner.

Den här produkten lämpar sig endast för avsedd användning i enlighet med denna bruksanvisning.

Den här manualen informerar om vad som krävs för att installera och/eller använda produkten på rätt sätt. Felaktig installation och/eller användning eller felaktigt underhåll kommer leda till att produkten inte fungerar optimalt och riskerar gå sönder.

Tillverkaren åtar sig inget ansvar för personsador eller materiella skador på produkten som uppstår till följd av:

- Felaktig montering eller anslutning, inklusive för hög spänning
- Felaktigt underhåll eller användning av reservdelar som inte är originaldelar från tillverkaren
- Ändringar som utförts utan uttryckligt medgivande från tillverkaren
- Användning för andra ändamål än de som beskrivs i denna bruksanvisning

Dometic förbehåller sig rätten att ändra produktens utseende och specifikationer.



## 5 Förklaringar av symboler på apparaten



Varning! Material med låg förbränningshastighet.



Läs bruksanvisningen.



Läs servicemanualen.

## 6 Tekniska gränser och förutsättningar

Den takmonterade klimatanläggningen är avsedd för fordon med en taktjocklek på 25 mm ... 60 mm. Den takmonterade klimatanläggningen har en garanterad funktion vid temperaturer på mellan - 2 °C ... 52 °C. Den takmonterade klimatanläggningen är konstruerad för att monteras horisontalt inom ± 10 °. Effekten på den takmonterade klimatanläggningen kan reduceras om den utsätts för starka vibrationer, t.ex. vid dåliga vägförhållanden.

## 7 Teknisk beskrivning

FreshJet FJX4233M takmonterad klimatanläggning tillför fordonets innerutrymme med sval luft utan damm eller smuts och kan avfuktas.

FreshJet FJX4233EEH/FJX4333E(EH)/FJX7333IHP/FJX7337IHP/FJX7457IHP takmonterad klimatanläggning tillför fordonets innerutrymme med sval eller varm luft utan damm eller smuts och kan avfuktas.

Den takmonterade klimatanläggningen kan sänka temperaturen i fordonet till en viss nivå, beroende på typ av fordon, omgivningstemperaturen och den takmonterade klimatanläggningens kyleffekt. Den takmonterade klimatanläggningen kyler inte längre om utomhustemperaturen är lägre än 16 °C.

Den takmonterade klimatanläggningen används med följande reglage:

- Kontrollpanel

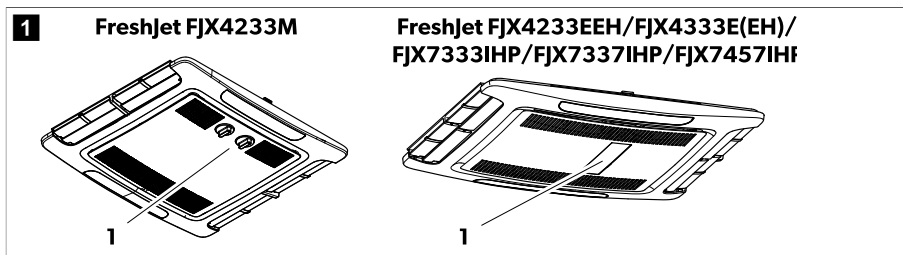

- Fjärrkontroll (bara FJX4233EEH/FJX4333E(EH)/FJX7333IHP/FJX7337IHP/FJX7457IHP)

## 7.1 Lista på modeller

Följande tabell visar vilken funktion som finns till de specifika modellerna:



● Funktionen är tillgänglig

○ Funktionen kan uppgraderas

	FJX4233M	FJX4233EEH	FJX4333EEH	FJX4333E	FJX7333IHP	FJX7337IHP	FJX7457IHP
Automatisk		●	●	●	●	●	●
Kylning	●	●	●	●	●	●	●
Värme		●	●	○	●	●	●
Ventilation	●	●	●	●	●	●	●
Avfuktning		●	●	●	●	●	●
Luftrenare	○	●	●	○	●	●	●
ADB-belysning		●	●	○	●	●	●
Extern belysning					●	●	●
Timer		●	●	●	●	●	●
Sovläget		●	●	●	●	●	●
Soft start			●	○	●	●	●

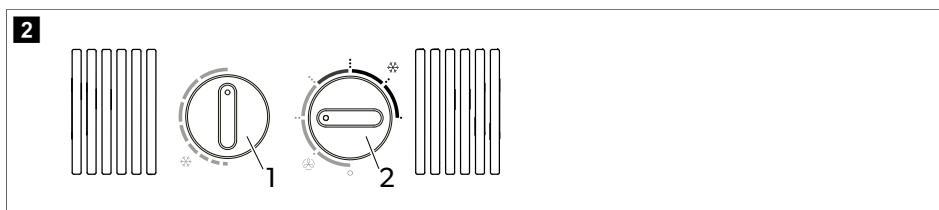
## 7.2 Kontrollpanel FreshJet FJX4233M



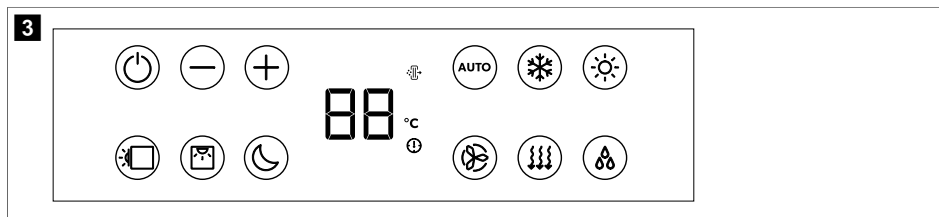

Reglage	Beskrivning
	Väljer temperaturen. Vrid medurs för högre kylning.
	Slår på eller stänger av den takmonterade klimatanläggningen och väljer styrka på luftcirkulationen i läget Ventilation (☪) eller styrka på kylningen i läget Kylning (❄️).

### 7.3 Kontrollpanel FreshJet FJX4233EEH/FJX4333E(EH)/FJX7333IHP/FJX7337IHP/FJX7457IHP



















Symbol	Beskrivning
	Slår på den takmonterade klimatanläggningen eller ställer den på standby-läge.
	Ökar det värde som visas för tillfället.
	Minskar det värde som visas för tillfället.
	Parkoppla med bluetooth/WLAN när båda knapparna trycks ned samtidigt.
	Slå på eller stänga av bakgrundslyset på takenheten.
	Slå på eller stänga av bakgrundslyset på luftfördelningslådan.
	Aktiverar sleep-funktionen (Extrafunktioner (bara FJX4233EEH/FJX4333E(EH)/FJX7333IHP/FJX7337IHP/FJX7457IHP) sida 230).
	Visar den inställda temperaturen och anger fläktnivån när fläkten har reglerats.
	Visar att luftrengöringsläget är aktivt.
	Visar att temperaturen visas i grader Celsius.
	Anger att timern är inställd.
	Aktiverar/inaktiverar automatläget (Klimatanläggningslägen (bara FJX4233EEH/FJX4333E(EH)/FJX7333IHP/FJX7337IHP/FJX7457IHP) sida 230).
	Aktiverar/inaktiverar kylläget (Klimatanläggningslägen (bara FJX4233EEH/FJX4333E(EH)/FJX7333IHP/FJX7337IHP/FJX7457IHP) sida 230).
	Aktiverar/inaktiverar värmeläget (Klimatanläggningslägen (bara FJX4233EEH/FJX4333E(EH)/FJX7333IHP/FJX7337IHP/FJX7457IHP) sida 230).
	Justera fläkthastigheten till Låg, Med, Hög, Turbo eller Auto (visas som 1, 2, 3, 4 eller AA på luftfördelningslådans display under en kort tid vid ändringar).

Symbol	Beskrivning
	Aktiverar/inaktiverar ventilationsläget (Klimatanläggningslägen (bara FJX4233EEH/FJX4333E(E-H)/FJX7333IHP/FJX7337IHP/FJX7457IHP) sida 230). Cirkulerar luft utan värme eller kylning.
	Aktiverar/inaktiverar avfuktningläget (Klimatanläggningslägen (bara FJX4233EEH/FJX4333E(E-H)/FJX7333IHP/FJX7337IHP/FJX7457IHP) sida 230).

## 7.4 Fjärrkontroll Freshjet FJX4233EEH/FJX4333E(EH)/FJX7333IHP/FJX7337IHP/FJX7457IHP





Reglage och indikeringar bild. **4** sida 228:

Knapp	Beskrivning
—	<p><b>Display</b></p> <p>Visar följande:</p> <ul style="list-style-type: none"> <li>• Klockslag</li> <li>• Vald rumstemperatur (målvärde) i °C</li> <li>• Faktisk rumstemperatur</li> <li>• Klimatanläggningsläge</li> <li>• Fläkthastighet</li> <li>• Symboler för aktiva extrafunktioner</li> <li>• Batteristatus</li> </ul>
	Slår på den takmonterade klimatanläggningen eller växlar till standby-läge.
	Ökar det värde som visas för tillfället.
	Minskar det värde som visas för tillfället.
	Väljer fläkthastigheten (Välja fläkthastighet manuellt sida 234).
	Väljer klimatanläggningsläget (Klimatanläggningslägen (bara FJX4233EEH/FJX4333E(EH)/FJX7333IHP/FJX7337IHP/FJX7457IHP) sida 230). Motsvarande symbol visas.
	Aktiverar sleep-funktionen (Extrafunktioner (bara FJX4233EEH/FJX4333E(EH)/FJX7333IHP/FJX7337IHP/FJX7457IHP) sida 230). Symbolen  visas.
	Bekräftar och sparar inställningar.
	Ställer in timern och klockan.
	Slå på eller stänga av bakgrundslyset på luftfördelningslådan.
	Tryck en gång för att visa aktuell innetemperatur. Symbolen  visas. Tryck två gånger för att visa ställa in temperaturen.
	Aktivera funktionen I feel. Symbolen  visas. Med "I feel"-funktionen anpassas måltemperaturen var 10 min till temperaturen som fjärrkontrollen mäter.
	Slå på eller stänga av bakgrundslyset på takenheten.
	Visar att fjärrkontrollens batterier är tomma. Byt batterierna (Byta fjärrkontrollens batterier sida 237).
	Visas att fjärrkontrollen skickar värden till den takmonterade klimatanläggningen.





## 7.5 Klimatanläggningslägen (bara FJX4233M)

Den takmonterade klimatanläggningen har följande klimatanläggningslägen:

Klimatanläggningsläge	Visad symbol	Beskrivning
Kylning		Du anger temperaturen och fläktnställningarna, så kyler den takmonterade klimatanläggningen invändigt till den här temperaturen.
Ventilation		Du anger fläktnställningarna och den takmonterade klimatanläggningen cirkulerar luft utan värme eller kylning.

## 7.6 Klimatanläggningslägen (bara FJX4233EEH/FJX4333E(EH)/FJX7333IHP/FJX7337IHP/FJX7457IHP)

Den takmonterade klimatanläggningen har följande klimatanläggningslägen:

Klimatanläggningsläge	Visad symbol	Beskrivning
Automatisk	<b>A</b>	Du anger temperaturen, så ställer den takmonterade klimatanläggningen om inomhustemperaturen till den inställda temperaturen genom kylning eller värme och genom att styra fläkthastigheten.
Kylning		Du anger temperaturen och fläktnställningarna, så kyler den takmonterade klimatanläggningen invändigt till den här temperaturen.
Värme		<b>Inte FJX4333E:</b> Du anger temperaturen och fläktnställningarna, så värmer den takmonterade klimatanläggningen invändigt till den här temperaturen. Fläkten startar endast efter 2 min (på Låg hastighet) och efter ca 5 min ställer den in sig på den inställda fläkthastigheten (när förångaren har uppnått den ifrågasvarande temperaturen).
Ventilation		Du anger fläktnställningarna och den takmonterade klimatanläggningen cirkulerar luft utan värme eller kylning.
Luftavfuktning		Den takmonterade klimatanläggningen avfuktar luften utan värme eller kylning genom att sänka den relativa luftfuktigheten.
Luftrenare		<b>Inte FJX4333E:</b> Den takmonterade klimatanläggningen joniserar luften och samlar därmed in damm och partiklar inklusive bakterier och virus från luften.

## 7.7 Extrafunktioner (bara FJX4233EEH/FJX4333E(EH)/FJX7333IHP/FJX7337IHP/FJX7457IHP)

Den takmonterade klimatanläggningen har följande extrafunktioner:

Extrafunktion	Meddelanden på displayen	Beskrivning
Timer		Den takmonterade klimatanläggningen aktiveras vid inställd tidpunkt.
		Den takmonterade klimatanläggningen stängs av vid inställd tidpunkt.
		Den takmonterade klimatanläggningen aktiveras och stängs av vid inställda tidpunkter.
Sovläget		Under sovläget reduceras fläkthastigheten och kompressorhastigheten så att bullernivåerna reduceras och det blir lättare att sova.
I Feel		Fjärrkontrollen mäter rumstemperaturen och skickar värdet var 10 min till den takmonterade klimatanläggningen. Den takmonterade klimatanläggningen anpassar måltemperaturen till detta mätvärde.
Soft start		<b>Inte FJX4233EEH:</b> Toppströmmen vid kompressorns start reduceras med hjälp av startfunktionen. Om en generator används som strömförsörjning överbelastas inte generatoren.

## 8 Före den första användningen

### Kontroller före idrifttagandet

Observera följande innan den takmonterade klimatanläggningen startas:

1. Kontrollera om försörjningsspänningen och frekvensen motsvarar de specificerade värdena i Tekniska data sida 244.
2. Kontrollera att det inte finns några hinder vid luftintagen och luftmunstyckena. Ventilationsgaller får under inga omständigheter vara blockerade för att säkerställa att den takmonterade klimatanläggningen kan köras med maxeffekt.

### Förbered fjärrkontrollen (bara FreshJet FJX4233EEH/FJX4333E(EH)/FJX7333IHP/FJX7337IHP/FJX7457IHP)

3. Sätt in batterierna (Byta fjärrkontrollens batterier sida 237).

### Ställ in tiden (bara FreshJet FJX4233EEH/FJX4333E(EH)/FJX7333IHP/FJX7337IHP/FJX7457IHP)

4. Ställ in aktuell tid (Ställa in aktuell tid sida 234).

## 9 Användning

### 9.1 Tips för bättre användning

Genom att följa de nedanstående tipsen kommer den takmonterade klimatanläggningen fungera optimalt:

- Förbättra värmeisoleringen på fordonet genom att täta spalter och hänga reflekterande rullgardiner eller gardiner framför fönstren.
- Välj passande temperatur och fläksteg.

- Rikta in munstyckena på ett lämpligt sätt.
- Se till att luftmunstycken och luftintag inte täcks över av tyg, papper eller andra material.
- **Bara FreshJet FJX4233EEH/FJX4333E(EH)/FJX7333IHP/FJX7337IHP/FJX7457IHP:** Om fordonet har varit utsatt för direkt solsken under en lång tid: Använd den takmonterade klimatanläggningen i läget Ventilation (☁) med öppna fönster en stund innan du slår på driftläget Kylning (❄️).
- **Bara FreshJet FJX4233EEH/FJX4333E(EH)/FJX7333IHP/FJX7337IHP/FJX7457IHP:** Öppna i möjligaste mån inte dörrar eller fönster i läget Kylning (❄️).

## 9.2 Grundläggande anvisningar för användning

FreshJet FJX4233M takmonterad klimatanläggning har tre driftlägen:

Driftläge	Beskrivning
Av	Den takmonterade klimatanläggningen är avstängd.
Kylning	Den takmonterade klimatanläggningen kylar innerutrymmet.
Ventilation	Den takmonterade klimatanläggningen cirkulerar luft utan kylning.

FreshJet FJX4233EEH/FJX4333E(EH)/FJX7333IHP/FJX7337IHP/FJX7457IHP takmonterade klimatanläggningar har två driftlägen:

Driftläge	Beskrivning
Standby	Den takmonterade klimatanläggningen är redo för drift och kan startas med fjärrkontrollen. Omgivningsbelysningen kan användas. Fjärrkontrollen är också i läget standby men du kan slå på fjärrkontrollen oberoende av den takmonterade klimatanläggningen.
På	Med hjälp av den takmonterade klimatanläggningen klimatiseras inomhusluften.

## 9.3 Dometic FJX4233M

Informationen i detta kapitel gäller endast FJX4233M takmonterade klimatanläggningar.

### 9.3.1 Slå på och stänga av den takmonterade klimatanläggningen

Den takmonterade klimatanläggningen har två klimatanläggningslägen:

- Ventilationsläge (☁)
- Kylläge (❄️)



**Anvisning** Innan du byter från ventilationsläge till kylläge eller omvänt, vänta minst 30 s. Annars kan omkopplingsströmmen göra att säkringen går.

Varje läge har tre inställningar:

- ..: Lågt



- ...: Medel
- ...: Hög
- >

För att slå på, vrid reglaget  till ventilationsläget (2) eller till kylläget (\*\*\*) och välj önskade inställningar.

✓ Den takmonterade klimatanläggningen slås på och körs med de värden som var inställda när den sist stängdes av.

>

För att stänga av, vrid reglaget  till position 0.

### 9.3.2 Ställa in temperaturen

>

Vrid reglaget  till önskad position. Vrid reglaget medurs för att få en lägre temperatur.

✓ Temperaturen är inställd i den takmonterade klimatanläggningen.

## 9.4 FreshJet FJX4233EEH/FJX4333E(EH)/FJX7333IHP/FJX7337IHP/FJX7457IHP

Informationen i detta kapitel gäller endast FreshJet FJX4233EEH/FJX4333E(EH)/FJX7333IHP/FJX7337IHP/FJX7457IHP takmonterade klimatanläggningar.

### 9.4.1 Med fjärrkontrollen

Observera följande anvisningar vid hantering av fjärrkontrollen:

- Peka med fjärrkontrollen mot IR-mottagaren på kontrollpanelen.
  - Inställningarna och värdena överförs direkt till den takmonterade klimatanläggningen när du trycker på en knapp.
  - Den takmonterade klimatanläggningen avger en ton för att bekräfta att data har tagits emot.
  - Värdena ökar eller minskar fortare om du trycker på och håller fast knapparna + eller –.
  - I standby-läget är fjärrkontrollens display inte aktiv. Du kan koppla fjärrkontrollen till standby oberoende av den takmonterade klimatanläggningen.
- > För att endast koppla fjärrkontrollen till eller från standby, tryck på knappen  utan att rikta den mot kontrollpanelens IR-mottagare.

### 9.4.2 Slå på den takmonterade klimatanläggningen och koppla den till standby



**Anvisning** Den takmonterade klimatanläggningen slås på och körs med de värden som var inställda när den sist kopplades till standby. Det är endast möjligt att stänga av den takmonterade klimatanläggningen genom att bryta strömmen.

- > Tryck på knappen  på fjärrkontrollen eller knappen  på kontrollpanelen för att slå på den takmonterade klimatanläggningen eller koppla den till standby.

### 9.4.3 Välja driftläge

- > Välj önskat klimatanläggningsläge med hjälp av knappen LÄGE (Klimatanläggningslägen (bara FJX4233EEH/ FJX4333E(EH)/FJX7333IHP/FJX7337IHP/FJX7457IHP) sida 230).
- ✓ Den takmonterade klimatanläggningen avger en ton för att bekräfta att värdena har tagits emot. Den takmonterade klimatanläggningen ställs på önskat driftläge.

### 9.4.4 Välja fläkthastighet manuellt

I alla lägen förutom i automatläget (A) och avfuktarläget (☉) kan fläkthastigheten väljas manuellt.

Meddelanden på displayen	Beskrivning
	Låg fläkthastighet
	Medium fläkthastighet
	Hög fläkthastighet.
	Turbo fläkthastighet.
	Automatläge (fläkthastigheten justeras beroende på omgivningstemperaturen).

- > Tryck på knappen ☉ på fjärrkontrollen eller knappen ☉ på kontrollpanelen för att välja önskad fläkthastighet.
- ✓ Den takmonterade klimatanläggningen avger en ton för att bekräfta att värdena har tagits emot.

Den nya fläkthastigheten har ställts in.

### 9.4.5 Ställa in temperaturen

I automatläget (A), kylkläget (❄️), värmeläget (☀️) och avfuktarläget (☉) kan du specificera en temperatur mellan 16 °C och 31 °C.

- > Använd knapparna + eller – på fjärrkontrollen för att ställa in önskad temperatur.
- ✓ Den takmonterade klimatanläggningen avger en hög ton för att bekräfta att värdena har tagits emot. Temperaturen är inställd i den takmonterade klimatanläggningen.

### 9.4.6 Ställa in aktuell tid

För timerprogrammeringen måste aktuell tid stämma på fjärrkontrollen. Tiden visas på fjärrkontrollens display.

1. Tryck och håll fast knappen ☉ för att komma till tidsinställningsläget.
  - ✓ Tiden blinkar på fjärrkontrollens display.
2. Ställ in aktuell tid med knapparna + eller –. Tryck och håll fast knapparna + eller – längre än 2 s för att öka eller minska inställningshastigheten.
3. Tryck på knappen SET för att bekräfta inställningen.

















### 9.4.7 Ställa in timern

Med timer-funktionen kan du ställa in önskad tid för klimatseringen. Du kan specificera aktiveringstiden, koppla-till-standby-tiden eller båda värdena.

Timer-funktionen ställs in via fjärrkontrollen.



**Anvisning** Fjärrkontrollen återgår till startläget om ingen knapp trycks in under 15 s medan timern programmeras.







- > Ställ in **aktivera timer** på följande sätt:
  - a) Välj önskat klimatanläggningsläge och alla nödvändiga värden (t.ex. temperatur).
  - b) Vid behov, koppla om den takmonterade klimatanläggningen till standby.  
Aktiveringstidern kan bara ställas in om den takmonterade klimatanläggningen är i **standby**.
  - c) Tryck på knappen  en gång.
    - ✓ Symbolen  blinkar på fjärrkontrollens display.
  - d) Använd knapparna + eller – för att ställa in tiden när den takmonterade klimatanläggningen ska slås på.
  - e) Tryck på knappen .  
Aktiveringstiden är inställd. Den takmonterad klimatanläggningen slås på med valt luftkonditioneringsläge vid inställd tid.
- > Ställ in **koppla till standby-timer** på följande sätt:
  - a) Vid behov, slå på den takmonterade klimatanläggningen.  
Koppla till standby-tidern kan bara ställas in om den takmonterade klimatanläggningen **på**.
  - b) Tryck två gånger på knappen .
    - ✓ Symbolen  blinkar på fjärrkontrollens display.
  - c) Använd knapparna + eller – för att ställa in tiden när den takmonterade klimatanläggningen ska kopplas om till standby.
  - d) Tryck på knappen .  
Timern för koppla om till standby är inställd. Den takmonterad klimatanläggningen kopplas om till standby vid inställd tidpunkt.
- > Ställ in **aktiveringstidern** och **koppla till standby-tidern** på följande sätt:
  - a) Välj önskat klimatanläggningsläge och alla nödvändiga värden (t.ex. temperatur).
  - b) Tryck tre gånger på knappen .
    - ✓ Symbolen    visas på fjärrkontrollens display. ON-symbolen blinkar.
  - c) Använd knapparna + eller – för att ställa in tiden när den takmonterade klimatanläggningen ska slås på.
  - d) Tryck på knappen .
    - ✓ **OFF**-symbolen blinkar.
  - e) Använd knapparna + eller – för att ställa in tiden när den takmonterade klimatanläggningen ska kopplas om till standby.
  - f) Tryck på knappen .
    - ✓ Aktiveringstiderna och koppla till standby-tiderna är inställda. Den takmonterade klimatanläggningen aktiveras för specificerad tidsperiod.
- > För att **avbryta** inställd timer, tryck på knappen  en gång.
  - ✓ Symbolerna    försvinner. De förinställda värdena raderas.

### 9.4.8 Ställa in sleep-funktionen

Sleep-funktionen kan endast aktiveras i kylläget (❄️) eller värmeläget (☀️).

Sleep-funktionen begränsar fläkthastigheten till en lägre nivå så att bullernivåerna sänks för en bättre sömn.

**Bara FJX7333IHP/FJX7337IHP/FJX7457IHP:** Sleep-funktionen begränsar även kompressorns hastighet.

- > Tillvägagångssätt för att aktivera sleep-funktionen:
  - a) Ställ in önskad temperatur (Ställa in temperaturen sida 234).
  - b) Tryck på knappen  på fjärrkontrollen eller knappen  på kontrollpanelen.
- ✓ Symbolen  visas på fjärrkontrollens display. Sovfunktionen är aktiverad.
- > För att avaktivera sleep-funktionen, tryck på knappen  eller  på fjärrkontrollen eller knappen  på kontrollpanelen.
- ✓ Symbolen  försvinner på fjärrkontrollens display. Sleep-funktionen är avaktiverad.

### 9.4.9 Aktivera funktionen I feel

I denna funktion mäter fjärrkontrollen rumstemperaturen och skickar värdet var 10:e minut till den takmonterade klimatanläggningen. Den takmonterade klimatanläggningen anpassar måltemperaturen till detta mätvärde. Funktionen "I feel" är endast aktiv när temperaturen ligger mellan +18 °C och +29 °C.

Fjärrkontrollen ska inte befinna sig på en plats i rummet som är mycket varmare eller kallare än den genomsnittliga rumstemperaturen. Den får t.ex. inte ligga i solen eller framför den takmonterade klimatanläggningen.

När temperaturen ökar över +29 °C eller sjunker under +18 °C, avaktiveras funktionen "I feel". Symbolen  blinkar tre gånger på displayen och stängs sedan av.

1. Tryck på knappen.
- ✓ Funktionen "I feel" är aktiverad.

Symbolen  visas på displayen.

2. Lägg fjärrkontrollen så att den pekar mot IR-mottagaren på kontrollpanelen. Annars kan inte värdena skickas till den takmonterade klimatanläggningen.



### 9.4.10 Använda bakgrundsbelysningen







**WARNING! Risk för personskada** Det är förbjudet enligt lag att använda extern belysning vid körning av fordonet.

Knappen  på fjärrkontrollen är aktiv även om fjärrkontrollen är avstängd.

**Bara FreshJet FJX4233EEH/FJX4333E(EH)/FJX7333IHP/FJX7337IHP/FJX7457IHP:**

- > För att tända eller släcka den interna belysningen, tryck på knappen  på fjärrkontrollen eller kontrollpanelen.
- ✓ Symbolen  blinkar en gång på fjärrkontrollens display när den interna belysningen är **på**.

- > Tillvägagångssätt för att dimma den interna belysningen:
  - a) Tryck på knappen  på fjärrkontrollen eller kontrollpanelen i 3 s.
  - b) När du trycker på knappen  på fjärrkontrollen: Tryck på knappen  för att dimma den interna belysningen mellan 50 % och 100 %.
  - c) När du trycker på knappen  på kontrollpanelen: Ljusstyrkan på den interna belysningen ändras mellan 50 % och 100 %. Släpp knappen  när önskad ljusstyrka är uppnådd.

#### Bara Freshjet FJX7333IHP/FJX7337IHP/FJX7457IHP:

- > För att tända eller släcka den externa belysningen, tryck på knappen  på kontrollpanelen.

### 9.4.11 Byta fjärrkontrollens batterier



**Anvisning** Fjärrkontrollens display kommer fortsätta lysa även när batterierna håller på att ta slut. Byt batterier när indikeringen låg batterinivå visas på fjärrkontrollen.

- > Byt ut batterierna enligt bilden.

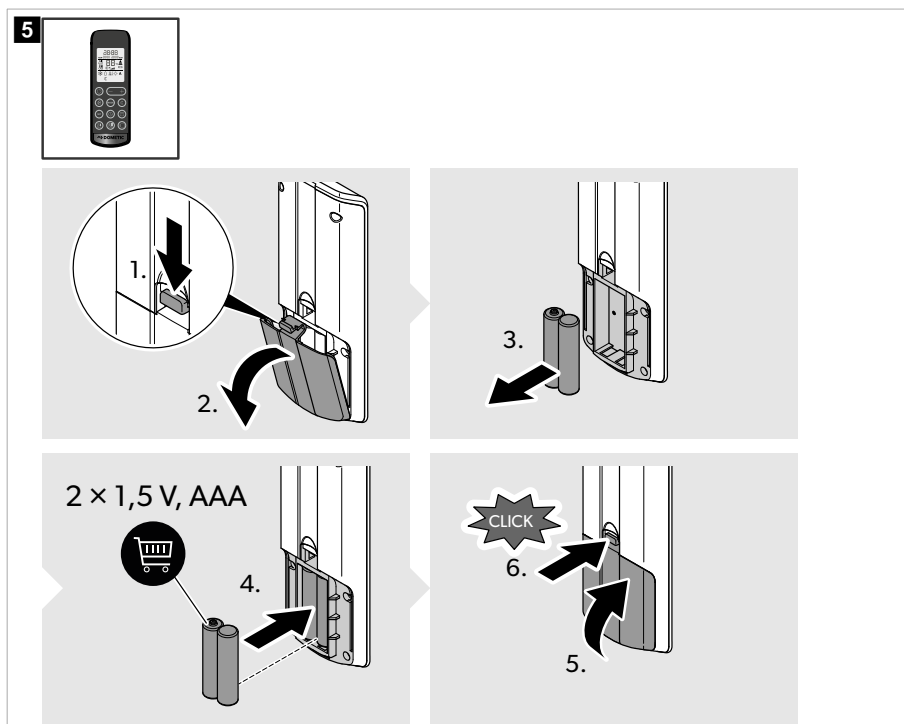

- ✓ På displayen visas alla symboler i 5 s.



Skydda miljön! Varken laddningsbara batterier eller andra batterier hör hemma i hushållssoporna. Lämna dina förbrukade eller defekta (laddningsbara) batterier till återförsäljaren eller till ett insamlingsställe.

## 9.5 Reglera luftförsörjningen i fordonet

Luftflödet kan ställas in längs med taket eller mot golvet.

- > Vrid på spjälorna i luftmunstyckena separat i önskad riktning.

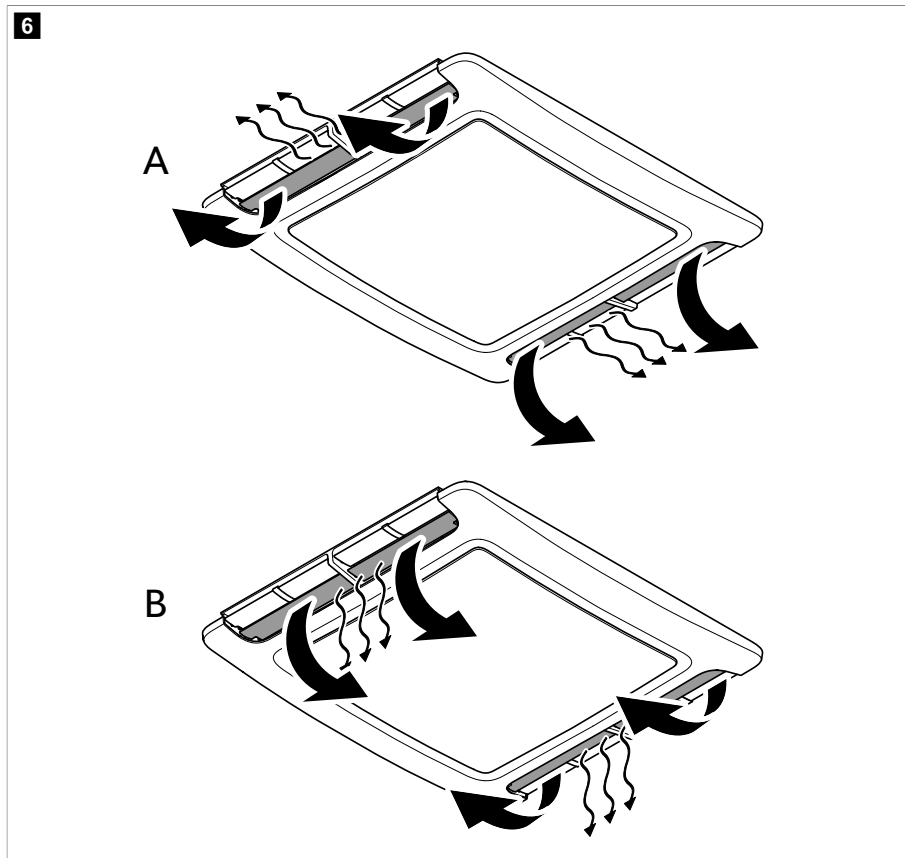

## 10 Rengöra takmonterad klimatanläggning



### OBSERVERA! Risk för skada

- Använd inga medel för att påskynda avfrostningsprocessen eller för att rengöra, utöver de som tillverkaren rekommenderar.
- Använd inte högtryckstvätt för att rengöra den takmonterade klimatanläggningen. Den takmonterade klimatanläggningen kan skadas om det kommer in vatten i den.
- Använd inga vassa eller hårda föremål för rengöring, använd inga skarpa rengöringsmedel; den takmonterade klimatanläggningen kan skadas.
- Använd inte bensin, diesel eller lösningsmedel.

1. Ta regelbundet bort löv och annan smuts från den takmonterade klimatanläggningens luftintag och ventilationsgaller. Skada inte ventilationsgallret under rengöringen.

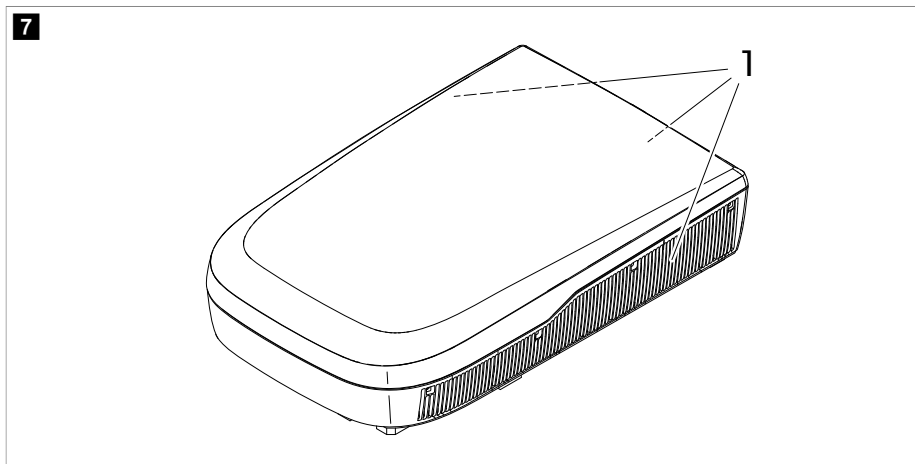

2. Rengör den takenheten och luftfördelningslådan då och då med en fuktig trasa. Använd endast vatten med lite rengöringsmedel.
3. **Bara FreshJet FJX4233EEH/FJX4333E(EH)/FJX7333IHP/FJX7337IHP/FJX7457IHP:** Rengör fjärrkontrollen då och då med en fuktig trasa. Rengör displayen med rengöringsduk för glas.
4. **Bara FreshJet FJX4233EEH/FJX4333E(EH)/FJX7333IHP/FJX7337IHP/FJX7457IHP** Rengör den luftfördelningslådan då och då med mildt rengöringsmedel och varmt vatten. Displayen är gjord av akrylglas och kan skadas av vanliga hushållskemikalier, som t.ex. Fönsterputsmedel, alkohol, vissa tensider, organiska lösningsmedel och mjukgörare.

## 11 Underhåll

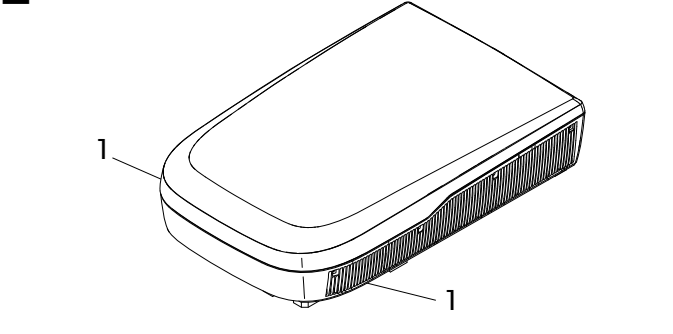
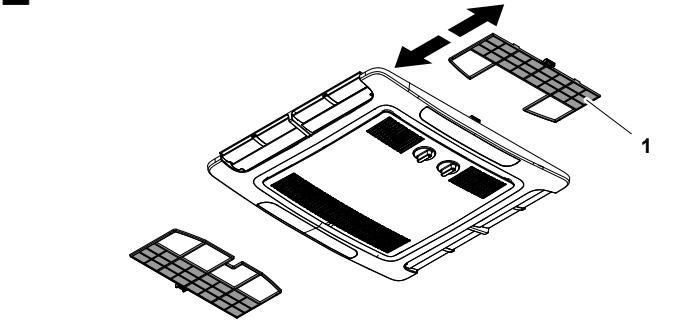

**WARNING! Risk för personskada** Annat underhåll än det som beskrivs här får endast genomföras av härför utbildad personal, som är förtrogen med riskerna vid hantering av köldmedier och klimatanläggningar och känner till gällande föreskrifter.

Intervall	Kontroll/underhåll
Regelbundet	<p data-bbox="333 188 1014 231">Kontrollera att avloppskanalerna för kondensvattnet (1) på den takmonterade klimatanläggningens sidor är fria från smuts och att kondensvattnet kan rinna ut.</p> <div data-bbox="333 247 1014 614"><p data-bbox="341 252 367 284"><b>8</b></p></div>
Regelbundet (FreshJet FJX4233M)	<p data-bbox="333 643 583 663">Rengör luftutsläppsenhetens filter.</p> <div data-bbox="333 679 1014 1046"><p data-bbox="341 684 367 716"><b>9</b></p></div> <ol data-bbox="348 1062 807 1126" style="list-style-type: none"><li>1. Ta bort filtret (1).</li><li>2. Rengör filtret (1) med ett rengöringsmedel och låt det torka.</li><li>3. Sätt tillbaka det torra filtret (1).</li></ol>

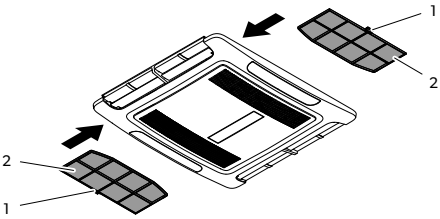

Intervall	Kontroll/underhåll
Regelbundet (Fresh-Jet FJX4233EEH/ FJX4333E(EH)/FJX7333IHP/ FJX7337IHP/FJX7457IHP)	<ul style="list-style-type: none"> <li>Rengör luftutsläppsenhetens filter.</li> </ul> <div data-bbox="367 225 1016 528" style="border: 1px solid black; padding: 10px;"> <p><b>10</b></p>  <ol style="list-style-type: none"> <li>För in en platt skruvmejsel eller kniv i handtaget (1) för att dra ut filtren (2) något.</li> <li>Ta bort filtren för hand.</li> <li>Rengör filtren med ett rengöringsmedel och låt dem torka.</li> <li>Skjut tillbaka de torra filtren. bild. 10 sida 241</li> </ol> </div> <ul style="list-style-type: none"> <li>Underhåll värmeväxlaren till den takmonterade klimatanläggningen på en specialverkstad.</li> </ul>
En gång per år	<ul style="list-style-type: none"> <li>Kontrollera att tätningarna mellan den takmonterade klimatanläggning och fordonets tak inte har sprickor eller är skadade.</li> <li>Kontrollera att fästskruvarna är åtdragna med korrekt vridmoment (2.5 Nm ± 0.3 Nm) och justera vid behov.</li> </ul>

## 12 Felsökning

Fel	Möjlig orsak	Lösning
Kyler inte tillräckligt	Den takmonterade klimatanläggningen har inte ställts in på kylning.	Ställ in den takmonterade klimatanläggningen på kylning.
	Omgivningstemperaturen är högre än 52 °C.	Den takmonterade klimatanläggningen är bara avsedd för en omgivningstemperatur på upp till 52 °C.
	Den inställda temperaturen är högre än rumstemperaturen.	Välj en lägre temperatur.
	Omgivningstemperaturen är lägre än 16 °C.	Den takmonterade klimatanläggningen är endast utformad för kylning vid omgivningstemperaturer på över 16 °C.
	En temperaturgivare är defekt.	Kontakta en auktoriserad servicerepresentant eller Dometic.
	Förångarfläkten är skadad.	Kontakta en auktoriserad servicerepresentant eller Dometic.

Fel	Möjlig orsak	Lösning
	Kondensatorfläkten är skadad.	Kontakta en auktoriserad servicerepresentant eller Dometic.
<b>Bara FreshJet FJX4233EEH/ FJX4333E(EH)/FJX7333IHP/ FJX7337IHP/FJX7457IHP:</b> Värmer inte tillräckligt	Den takmonterade klimatanläggningen har inte ställts in på värme.	Ställ in den takmonterade klimatanläggningen på värme.
	Omgivningstemperaturen är lägre än $-2\text{ }^{\circ}\text{C}$ .	Den takmonterade klimatanläggningen är endast utformad för omgivningstemperaturer på över $-2\text{ }^{\circ}\text{C}$ .
	Den inställda temperaturen är lägre än rumstemperaturen.	Välj en högre temperatur.
	En temperaturgivare är defekt.	Kontakta en auktoriserad servicerepresentant eller Dometic.
	Förångarfläkten är skadad.	Kontakta en auktoriserad servicerepresentant eller Dometic.
Svagt luftflöde	Luftintagen är igentäppta eller blockerade.	Ta bort löv och annan smuts från den takmonterade klimatanläggningens ventilationsgaller.
	Fläkten är defekt.	Kontakta en auktoriserad servicerepresentant eller Dometic.
Det kommer in vatten i fordonet.	Utloppsöppningarna för kondensvatten är tilltäppta.	Rengör utloppsöppningarna för kondensvatten.
	Tätningarna skadade.	Kontakta en auktoriserad servicerepresentant eller Dometic.
Den takmonterade klimatanläggningen startar inte.	Ingen strömförsörjning ansluten.	Kontrollera strömtillförseln.
	Spänningen är för låg ( $< 200\text{ V}$ ).	Kontakta en auktoriserad servicerepresentant eller Dometic.
	Spänningsomvandlaren defekt.	Kontakta en auktoriserad servicerepresentant eller Dometic.
	En temperaturgivare är defekt.	Kontakta en auktoriserad servicerepresentant eller Dometic.
	Strömförsörjningens elektriska säkring är för låg.	Kontakta en auktoriserad servicerepresentant eller Dometic.
Den takmonterade klimatanläggningen stänger inte av.	En temperaturgivare är defekt.	Kontakta en auktoriserad servicerepresentant eller Dometic.
	Strömförsörjningens elektriska säkring är för låg.	Kontakta en auktoriserad servicerepresentant eller Dometic.
<b>Bara FreshJet FJX4233EEH/ FJX4333E(EH)/FJX7333IHP/ FJX7337IHP/FJX7457IHP:</b> Den takmonterade klimatanläggningen stängs av om och om igen.	Frostgivaren har aktiverats.	Utomhustemperaturen är för låg eller också är alla luftmunstycken stängda.

Fel	Möjlig orsak	Lösning
Displayen visar: P0	Övertemperatur eller överström på IPM-modulen	Kontakta en auktoriserad servicerepresentant eller Dometic.
Displayen visar: P1	Underspänningskydd	Kontakta en auktoriserad servicerepresentant eller Dometic.
Displayen visar: P2	Överströmsskydd växelströmsenhet	Kontakta en auktoriserad servicerepresentant eller Dometic.
Displayen visar: P4	Överhettningsskydd urladdningsrör	Kontakta en auktoriserad servicerepresentant eller Dometic.
Displayen visar: P5	Skydd för förångarspole (kylningsläge)	Kontakta en auktoriserad servicerepresentant eller Dometic.
Displayen visar: P6	Skydd för kondensorspole (kylningsläge)	Kontakta en auktoriserad servicerepresentant eller Dometic.
Displayen visar: P7	Skydd för förångarspole (uppvärmningsläge)	Kontakta en auktoriserad servicerepresentant eller Dometic.
Displayen visar: P9	Drivning kompressor avvikande eller kompressor startar inte	Kontakta en auktoriserad servicerepresentant eller Dometic.
Displayen visar: E0	Kommunikationsfel	Kontakta en auktoriserad servicerepresentant eller Dometic.
Displayen visar: E1	Fel på rumstemperaturgivare	Kontakta en auktoriserad servicerepresentant eller Dometic.
Displayen visar: E2	Fel på temperaturgivare förångarspole	Kontakta en auktoriserad servicerepresentant eller Dometic.
Displayen visar: E3	Fel på temperaturgivare kondensorspole	Kontakta en auktoriserad servicerepresentant eller Dometic.
Displayen visar: E7	Fel på temperaturgivare utomhus	Kontakta en auktoriserad servicerepresentant eller Dometic.
Displayen visar: E8	Fel på temperaturgivare urladdningsrör	Kontakta en auktoriserad servicerepresentant eller Dometic.
Displayen visar: E9	Fel på drivning kompressor eller IPM-modul	Kontakta en auktoriserad servicerepresentant eller Dometic.
Displayen visar: EA	Fel på strömsensor	Kontakta en auktoriserad servicerepresentant eller Dometic.
Displayen visar: EE	Fel på EEPROM utomhus	Kontakta en auktoriserad servicerepresentant eller Dometic.
Displayen visar: EL	LIN-BUS/CI-BUS kommunikationsfel	Kontakta en auktoriserad servicerepresentant eller Dometic.

## 13 Avfallshantering



Placera förpackningsmaterialet i motsvarande återvinningsbehållare om möjligt. Konsultera ett lokalt återvinningscenter eller en specialiserad återförsäljare för information om hur man bortkaffar produkten i enlighet med tillämpliga bortskaffningsförfordningar.



Skydda miljön! Varken laddningsbara batterier eller andra batterier hör hemma i hushållssoporna. Lämna dina förbrukade eller defekta (laddningsbara) batterier till återförsäljaren eller till ett insamlingsställe.

## 14 Garanti

Den lagstadgade garantitiden gäller. Kontakta tillverkarens filial i ditt land (se [dometic.com/dealer](http://dometic.com/dealer)) eller din återförsäljare om produkten är defekt.

Vid reparations- och garantiärenden ska följande dokument skickas med när du returnerar produkten:

- En kopia på fakturan med inköpsdatum
- En reklamerationsbeskrivning eller felbeskrivning

Observera att självständiga eller icke professionella reparationer kan påverka säkerheten och leda till att garantin blir ogiltig.

## 15 Tekniska data

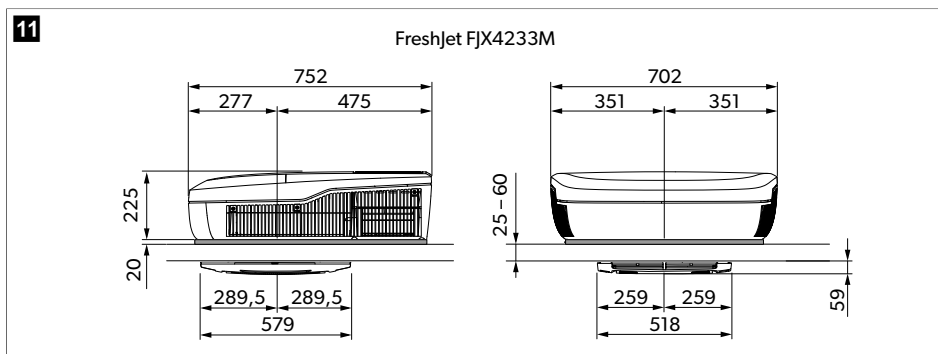

12

FJX4233EEH, FJX4333E(EH), FJX7333IHP

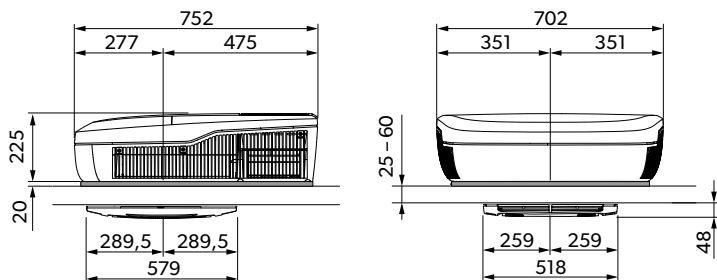

13

FreshJet FJX7337IHP

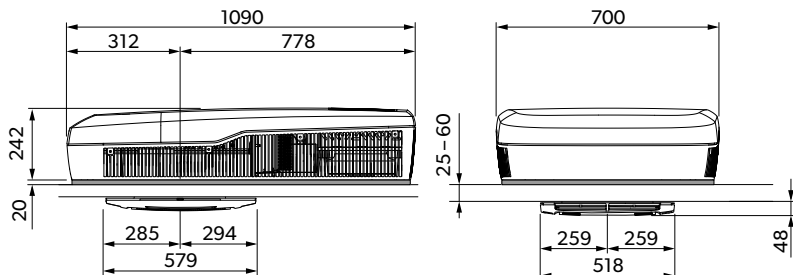

14

FreshJet FJX7457IHP

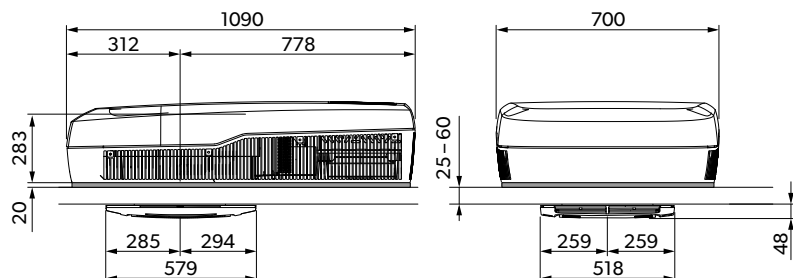

Innehåller fluorerade växthusgaser. Hermetiskt tillsluten utrustning.

	<b>FreshJet FJX4233M</b>
Kyleffekt enligt ISO 5151:	1500 W
AC ingångsspänning:	220 V ... 240 V / 50 Hz
Märkström kylning:	< 3.3 A

	<b>FreshJet FJX4233M</b>
Säkringskrav:	4 A
Omgivningstemperatur:	- 2 °C ... 52 °C
Köldmedium:	R410a
Köldmediemängd:	380 g
CO <sub>2</sub> motsvarande:	0.793 t
Global uppvärmningspotential (GWP):	2088
Skyddsklass (takenhet):	IPX4
Bullernivå (högsta fläktläge)	< 70 dB(A)
Rekommenderad max. fordonslängd (med isolerade väggar):	< 5 m
Mått L x B x H:	bild. <b>11</b> sida 244
Vikt:	< 30 kg
Provning/certifikat:	

	<b>FreshJet FJX4233EEH</b>	<b>FreshJet FJX4333EEH</b>	<b>FreshJet FJX4333E</b>
Kyleffekt enligt ISO 5151:	1700 W	2200 W	2200 W
Värmeeffekt enligt ISO 5151:	800 W	1000 W	-
AC ingångsspänning:	220 V ... 240 V / 50 Hz		
Märkström kylning:	3.6 A	4.8 A	4.8 A
Märkström värme:	< 5.2 A	< 5.2 A	-
Säkringskrav:	4 A	5 A	6 A
Omgivningstemperatur:	- 2 °C ... 52 °C		
Köldmedium:	R32		
Köldmediemängd:	320 g	360 g	360 g
CO <sub>2</sub> motsvarande:	0.216 t	0.243 t	0.243 t
Global uppvärmningspotential (GWP):	675		

	FreshJet FJX4233EEH	FreshJet FJX4333EEH	FreshJet FJX4333E
Skyddsklass (takenhet):	IPX4		
Bullernivå (högsta fläktläge)	< 70 dB(A)		
Rekommenderad max. fordonsslängd (med isolerade väggar):	< 6 m	< 7 m	< 7 m
Mått L x B x H:	bild. <b>12</b> sida 245		
Vikt:	< 30 kg	< 30 kg	< 30 kg
Provning/certifikat:			

	FreshJet FJX7333IHP	FreshJet FJX7337IHP	FreshJet FJX7457IHP
Kyleffekt enligt ISO 5151:	2200 W	3000 W	3500 W
Värmeeffekt enligt ISO 5151:	2000 W	2500 W	3000 W
AC ingångsspänning:	220 V ... 240 V / 50 Hz ... 60 Hz	220 V ... 240 V / 50 Hz ... 60 Hz	220 V ... 240 V / 50 Hz ... 60 Hz
Märkström kylning:	< 7.5 A	< 7.5 A	< 7.5 A
Märkström värme:	< 6.1 A	< 6.1 A	< 6.1 A
Säkringskrav:	6 A	6 A	6 A
Omgivningstemperatur:	- 2 °C ... 52 °C	- 2 °C ... 52 °C	- 2 °C ... 52 °C
Köldmedium:	R32	R32	R32
Köldmediemängd:	420 g	480 g	650 g
CO <sub>2</sub> motsvarande:	0.2835 t	0.3240 t	0.43875 t
Global uppvärmningspotential (GWP):	675		
Skyddsklass (takenhet):	IPX4		
Bullernivå (högsta fläktläge)	< 70 dB(A)		
Rekommenderad max. fordonsslängd (med isolerade väggar):	< 7 m	< 7 m	> 8 m
Mått L x B x H:	bild. <b>12</b> sida 245	bild. <b>13</b> sida 245	bild. <b>14</b> sida 245
Vikt:	< 30 kg	< 35 kg	< 40 kg

	FreshJet FJX7333IHP	FreshJet FJX7337IHP	FreshJet FJX7457IHP
Provning/certifikat:			



## Norwegian

1	Important notes.....	249
2	Symbolforklaring.....	249
3	Sikkerhetsanvisninger.....	250
4	Forskriftsmessig bruk.....	251
5	Symbolforklaring på apparatet.....	251
6	Tekniske begrensninger og betingelser.....	252
7	Teknisk beskrivelse.....	252
8	Før første gangs bruk.....	258
9	Betjening.....	258
10	Rengjøring av takklimaapparatet.....	266
11	Vedlikehold.....	266
12	Feilretting.....	268
13	Avfallshåndtering.....	270
14	Garanti.....	271
15	Tekniske spesifikasjoner.....	271

## 1 Important notes

Vennligst les disse instruksjonene nøye og følg alle anvisninger, retningslinjer og advarsler i denne produktveiledningen for å sikre at du installerer, bruker og vedlikeholder produktet ordentlig til enhver tid. Disse instruksjonene MÅ alltid følge med produktet.

Ved å bruke dette produktet bekrefter du at du har lest alle anvisninger, retningslinjer og advarsler grundig, og at du forstår og samtykker i å overholde vilkårene slik de er presentert her. Du godtar å bruke dette produktet kun til tiltenkt formål og bruksområder, og i samsvar med anvisningene, retningslinjene og advarslene slik de er presentert i denne produktveiledningen, så vel som i samsvar med alle gjeldende lovbestemmelser og forskrifter. Hvis anvisningene og advarslene som er presentert her, ikke blir lest og fulgt, kan det føre til personskader hos deg selv eller andre, skader på produktet eller skader på annen eiendom i nærheten. Denne produktveiledningen med sine anvisninger, retningslinjer og advarsler, samt relatert dokumentasjon, kan være underlagt endringer og oppdateringer. For oppdatert produktinformasjon, se [documents.dometic.com](http://documents.dometic.com).

## 2 Symbolforklaring



**FARE!** Kjentetegner en farlig situasjon som, dersom den ikke unngås, vil føre til alvorlige personskader, eventuelt med døden til følge.



**ADVARSEL!** Kjentetegner en farlig situasjon som, dersom den ikke unngås, vil føre til alvorlige personskader, eventuelt med døden til følge.



**FORSIKTIG!** Kjentetegner en farlig situasjon som - dersom den ikke unngås - kan resultere i mindre til moderate personskader.



**PASS PÅ!** Kjenntegner en farlig situasjon som - dersom den ikke unngås - kan resultere i mindre til moderate personskader.



**Merk** Ytterligere informasjon om betjening av produktet.

### 3 Sikkerhetsanvisninger



**ADVARSEL! Manglende overholdelse av disse advarslene kan resultere i alvorlige personskader, eventuelt med døden til følge.**

- **Elektriske apparater er ikke leketøy.** Apparatet må ikke brukes av personer (inkludert barn) med reduserte fysiske, sensoriske eller mentale evner, eller som mangler erfaring og kunnskap, så sant de ikke er under oppsyn eller har fått veiledning.
- Barn bør være under tilsyn for å sikre at de ikke leker med apparatet.
- Dette apparatet kan brukes av barn fra 8 år og oppover og personer med reduserte fysiske, sensoriske eller mentale evner eller som mangler erfaring og kunnskap, hvis de er under oppsyn eller har fått veiledning i hvordan apparatet brukes på en forsvarlig måte og forstår hvilke farer det innebærer.
- Rengjøring skal ikke utføres av barn uten at de er under oppsyn.
- Enhver person som er involvert i arbeid på eller å ta tilgang til et kjølekretsløp, bør ha et aktuelt gyldig sertifikat fra et bransjeakkreditert vurderingsmyndighet som godkjenner deres kompetanse til å håndtere kjølemedler på en sikker måte og i samsvar med en vurderingsspesifikasjon som er anerkjent av bransjen.
- Vedlikehold skal bare utføres som anbefalt av utstyrproduzenten. Vedlikehold og reparasjon som krever assistanse av annet kvalifisert personell, skal utføres under oppsyn av personen som er kompetent i bruken av lettantennelige kjølemedler.
- Reparasjon av apparatet må kun utføres av kvalifisert personell som er kjent med farene hhv. gjeldende forskrifter. Usakkyndige reparasjoner kan føre til alvorlige farer. Ved behov for reparasjon kontakter du servicestedene i ditt land (se [dometic.com/dealer](http://dometic.com/dealer)).
- Fjern alltid strømforsyningen før det utføres arbeid på apparatet.
- Enheten skal lagres i et rom uten kontinuerlig betjening av tenningskilder som f.eks. åpne flammer, et gående gassapparat eller et gående elektrisk oppvarmingsapparat.
- Ikke stikk hull på eller brenn apparatet.
- Vær oppmerksom på at kjølemedler ikke nødvendigvis avgir lukt.
- Plasser ikke apparatet i nærheten av lettantennelige væsker eller i lukkede rom.
- Påse at brennbare gjenstander ikke lagres eller monteres i nærheten av luftutløpene. Det må overholdes en avstand på minst 50 cm.
- Hold ventilasjonsåpningene fri for hindringer.
- Unngå å skade kuldekretsløpet.
- Ikke under noen omstendigheter skal potensielle tenningskilder brukes for å lete etter eller registrere kjølemiddellekkasjer. En halogenfakkel (eller enhver annen detektor som benytter åpen ild) skal ikke brukes.
- Takklimaanlegget skal installeres i et kjøretøy med en gulvplass på mer enn 4 m<sup>2</sup>.

**FORSIKTIG! Manglende overholdelse av disse forsiktighetsvarslene kan resultere i mindre til moderate personskader.**

- Ta ikke inn i luftutløpene, og før ikke fremmedlegemer inn i apparatet.
- Ikke åpne det øvre dekselet til apparatet i tilfelle brann. Bruk kun lovlige slukkemidler. Ikke bruk vann til slukking.
- Hvis forsyningskabelen er skadet må den byttes ut av produsenten, dennes kundeservice eller tilsvarende kvalifisert personell, for å unngå farer.
- Dersom apparatet inneholder et ioniseringsmiddel, må du rådføre deg med en lege hvis du har et helseproblem. Ioniseringsmiddelet kan produsere ozon (O<sub>3</sub>) i små mengder. Hvis du har en lungesykdom, astma, hjertesykdom, luftveissykdom, åndedrettsproblemer, eller har en sensibilitet overfor ozon, må du konsultere legen din for å bestemme om bruken av denne enheten er sikker for deg.

**PASS PÅ! Fare for skader**

- Ikke ty til andre midler enn de som er anbefalt av produsenten til opptuningsprosessen eller rengjøringen.
- Apparatet skal lagres slik at man unngår at det oppstår mekaniske skader.
- Ikke foreta endringer eller ombygging av apparatet!
- Kjør aldri gjennom et automatisk vaskeanlegg dersom enheten er påmontert.
- Hvis det oppstår feil på kjølekretsløpet, må enheten sjekkes og repareres av produsenten, dennes serviceverksted eller tilsvarende kvalifisert personell, for å unngå farer.

## 4 Forskriftsmessig bruk

Takklimaanlegget FreshJet FJX er kun konstruert for montering på taket av en campingvogn eller et fritidskjøretøy for å gi kjøling.

Takklimaanlegget er **ikke** egnet for tog, hus og leiligheter. Takklimaanlegget er **ikke** egnet for montering i anleggsmaskiner, jordbruksmaskiner eller lignende anleggssystemer.

Dette produktet er kun egnet for det tiltenkte formålet og bruksområdet i samsvar med disse instruksjonene.

Denne veiledningen gir informasjon som er nødvendig for korrekt installasjon og/eller bruk av produktet. Feilaktig installasjon og/eller ukorrekt bruk eller vedlikehold vil resultere i en utilfredsstillende ytelse og mulig svikt.

Produsenten fraskriver seg ethvert ansvar for personskader eller materielle skader på produktet som følge av:

- Ukorrekt montering eller tilkobling, inkludert for høy spenning
- Ukorrekt vedlikehold eller bruk av andre reservedeler enn originale reservedeler levert av produsenten
- Modifisering av produktet uten at det er gitt uttrykkelig godkjenning av produsenten
- Bruk til andre formål enn beskrevet i denne veiledningen

Dometic forbeholder seg rettigheten til å endre produktet ytre og produktspesifikasjoner.

## 5 Symbolforklaring på apparatet



Advarsel! Material med lav forbrenningshastighet.



Les bruksanvisningen.



Les servicehåndboken.

## 6 Tekniske begrensninger og betingelser

Takklimaanlegget er ment for kjøretøy med et tak med en tykkelse på 25 mm ... 60 mm. Funksjonen til takklimaanlegget er garantert for omgivelsestemperaturer mellom  $-2^{\circ}\text{C}$  ...  $52^{\circ}\text{C}$ . Takklimaanlegget er konstruert for montering innenfor  $\pm 10^{\circ}$  i forhold til horisontalt plan. Effekten til takklimaanlegget kan bli redusert hvis det utsettes for kraftige vibrasjoner, for eksempel forårsaket av dårlige veiforhold.

## 7 Teknisk beskrivelse

Takklimaanlegget FreshJet FJX4233M forsyner kupeen i kjøretøyet med kjølig luft som er fri for støv og smuss og kan avfuktes.

Takklimaanlegget FreshJet FJX4233EEH/FJX4333E(EH)/FJX7333IHP/FJX7337IHP/FJX7457IHP forsyner kupeen i kjøretøyet med kjølig luft som er fri for støv og smuss og kan avfuktes.

Takklimaanlegget kan senke temperaturen inne i kjøretøyet til en innstilt verdi som avhenger av kjøretøytypen, omgivelsestemperaturen og kjøleeffekten til takklimaanlegget. Under en utetemperatur på  $16^{\circ}\text{C}$  kjøler ikke takklimaanlegget lenger.

Takklimaanlegget kan betjenes med følgende betjeningsselementer:

- Betjeningspanel

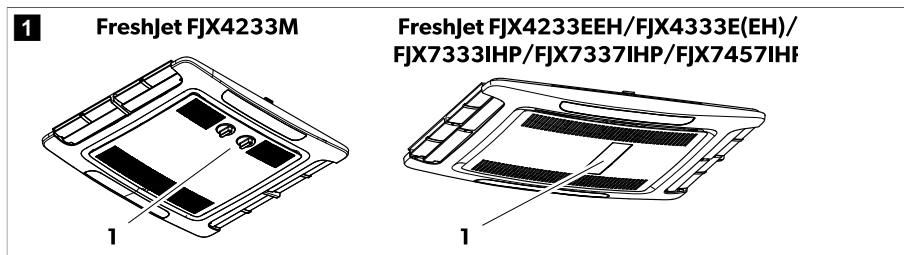

- Fjernkontroll (kun FJX4233EEH/FJX4333E(EH)/FJX7333IHP/FJX7337IHP/FJX7457IHP)

### 7.1 Liste over modeller

Den følgende tabellen viser hvilken funksjon som gjelder for en spesifikk modell:



- Egenskapen er tilgjengelig

○ Egenskapen kan oppgraderes

	FJX4233M	FJX4233EEH	FJX4333EEH	FJX4333E	FJX7333IHP	FJX7337IHP	FJX7457IHP
Automatisk		●	●	●	●	●	●
Kjøling	●	●	●	●	●	●	●
Oppvarming		●	●	○	●	●	●
Ventilasjon	●	●	●	●	●	●	●
Avfukting		●	●	●	●	●	●
Luftrenser	○	●	●	○	●	●	●
ADB-lampe		●	●	○	●	●	●
Eksternt lys					●	●	●
Timer		●	●	●	●	●	●
Sleep		●	●	●	●	●	●
Soft start			●	○	●	●	●

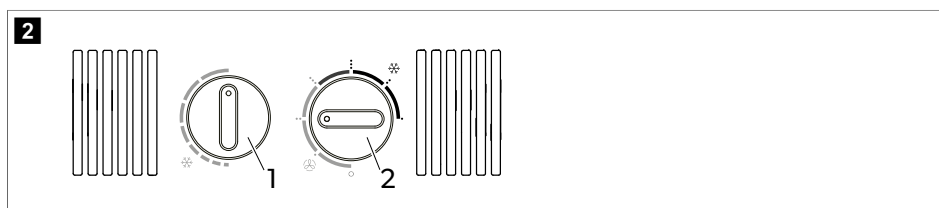
## 7.2 Betjeningspanel FreshJet FJX4233M



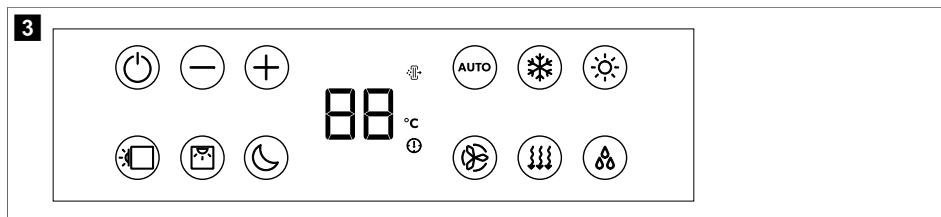

Knapp	Beskrivelse
	Stiller inn temperaturen. Drei med urviseren for mer kjøling.
	Slår takklimaenlegget på eller av, og velger intensiteten til luft sirkulasjonen i "Ventilasjon"-modus (🌀) eller kjøleintensitet i "Kjøling"-modus (❄️).

### 7.3 Betjeningspanel FreshJet FJX4233EEH/FJX4333E(EH)/FJX7333IHP/ FJX7337IHP/FJX7457IHP



















Symbol	Beskrivelse
	Slås på takklimaenlegget eller setter det i standbymodus.
	Øker den aktuelt viste verdien.
	Reduserer den aktuelt viste verdien.
	Forbinder med bluetooth/WLAN når begge knappene trykkes inn samtidig.
	Slår omgivelseslyset på hustakenheten på eller av.
	Slår omgivelseslyset på luftfordelingsboksen på eller av.
	Aktiverer Sleep-funksjonen (Tilleggsfunksjoner (kun FJX4233EEH/FJX4333E(EH)/FJX7333IHP/FJX7337IHP/ FJX7457IHP) på side 257).
	Viser den innstilte temperaturen og indikerer viftenivå når viften justeres.
	Indikerer at AirPurifier er aktiv.
	Indikerer at temperaturen er vist i grader Celsius.
	Indikerer at timeren er stilt inn.
	Aktiverer/deaktiverer automatisk drift (Klimaenleggsmoduser (kun FJX4233EEH/FJX4333E(EH)/FJX7333IHP/ FJX7337IHP/FJX7457IHP) på side 257).
	Aktiverer/deaktiverer kjøledrift (Klimaenleggsmoduser (kun FJX4233EEH/FJX4333E(EH)/FJX7333IHP/ FJX7337IHP/FJX7457IHP) på side 257).
	Aktiverer/deaktiverer varmedrift (Klimaenleggsmoduser (kun FJX4233EEH/FJX4333E(EH)/FJX7333IHP/ FJX7337IHP/FJX7457IHP) på side 257).
	Justerer viftehastigheten mellom Lav, Mid, Høy, Turbo eller Auto (vist som 1, 2, 3, 4 eller AA på displayet til luft- fordelingsboksen for en kort tid ved endring).

Symbol	Beskrivelse
	Aktiverer/deaktiverer ventilasjonsdrift (Klimaanleggsmoduser (kun FJX4233EEH/FJX4333E(EH)/FJX7333IHP/FJX7337IHP/FJX7457IHP) på side 257). Sirkulerer luft uten å varme eller kjøle.
	Aktiverer/deaktiverer avfuktingsdrift (Klimaanleggsmoduser (kun FJX4233EEH/FJX4333E(EH)/FJX7333IHP/FJX7337IHP/FJX7457IHP) på side 257).

## 7.4 Fjernkontroll FreshJet FJX4233EEH/FJX4333E(EH)/FJX7333IHP/FJX7337IHP/FJX7457IHP





Styre- og visningselementer fig. **4** på side 255

Knapp	Beskrivelse
—	<p><b>Display</b></p> <p>Viser følgende:</p> <ul style="list-style-type: none"> <li>• Klokkeslett</li> <li>• Valgt romtemperatur (innst. verdi) i °C</li> <li>• Faktisk romtemperatur</li> <li>• Klimamodus</li> <li>• Viftehastighet</li> <li>• Symboler for aktive tilleggsfunksjoner</li> <li>• Batteristatus</li> </ul>
	Slår takklimaenlegget på eller til standbymodus.
	Øker den aktuelt viste verdien.
	Reduserer den aktuelt viste verdien.
	Stiller inn viftehastigheten (Velg viftehastighet manuelt på side 261).
	Velger klimamodus (Klimaenleggsmoduser (kun FJX4233EEH/FJX4333E(EH)/FJX7333IHP/FJX7337IHP/FJX7457IHP) på side 257). Det korresponderende symbolet vises.
	Aktiverer Sleep-funksjonen (Tilleggsfunksjoner (kun FJX4233EEH/FJX4333E(EH)/FJX7333IHP/FJX7337IHP/FJX7457IHP) på side 257).  -symbolet vises.
	Bekrefter og lagrer innstillingene.
	Still inn timeren og klokken.
	Slår omgivelseslyset på luftfordelingsboksen på eller av.
	Trykk en gang for å vise den aktuelle innnetemperaturen.  -symbolet vises. Trykk to ganger for å vise den innstilte temperaturen.
	Aktiverer "I feel"-funksjonen.  -symbolet vises. Hvert 10 min justerer "I feel"-funksjonen innstilt temperatur til den faktiske temperaturen som fjernkontrollen måler.
	Slår omgivelseslyset på hustakenheten på eller av.
	Viser at fjernkontrollens batterier er tomme. Bytt batteriene (Bytte batterier i fjernkontrollen på side 264).
	Viser at fjernkontrollen sender verdier til takklimaenlegget.





## 7.5 Klimaanleggsmodus (kun FJX4233M)

Takklimaanlegget har følgende klimamoduser:

Klimamodus	Viste symboler	Beskrivelse
Kjøling		Du spesifiserer temperaturen og vifteinnstillingene, og takklimaanlegget avkjøler kupeen til denne temperaturen.
Ventilasjon		Du bestemmer vifteinnstillingene, takklimaanlegget sirkulerer luft uten å varme eller kjøle.

## 7.6 Klimaanleggsmoduser (kun FJX4233EEH/FJX4333E(EH)/FJX7333IHP/FJX7337IHP/FJX7457IHP)

Takklimaanlegget har følgende klimamoduser:

Klimamodus	Viste symboler	Beskrivelse
Automatisk	<b>A</b>	Du spesifiserer temperaturen og takklimaanlegget bringer kupeen til denne innetemperaturen ved oppvarming eller avkjøling, og ved å kontrollere den nødvendige viftehastigheten.
Kjøling		Du spesifiserer temperaturen og vifteinnstillingene, og takklimaanlegget avkjøler kupeen til denne temperaturen.
Oppvarming		<b>Ikke FJX4333E:</b> Du spesifiserer temperaturen og vifteinnstillingene, og takklimaanlegget varmer opp kupeen til denne temperaturen. Viften starter først etter 2 min (på lav hastighet) og går etter ca. 5 min til den innstilte viftehastigheten (etter at fordampener når temperaturen).
Ventilasjon		Du bestemmer vifteinnstillingene, takklimaanlegget sirkulerer luft uten å varme eller kjøle.
Luftavfuking		Takklimaanlegget fjerner fuktighet fra luften uten å varme eller kjøle kupeen, og reduserer dermed den relative luftfuktigheten.
Luftrensing		<b>Ikke FJX4333E:</b> Takklimaanlegget ioniserer luften og samler dermed støv og partikler, inkludert virus og bakterier, fra luften.

## 7.7 Tilleggsfunksjoner (kun FJX4233EEH/FJX4333E(EH)/FJX7333IHP/FJX7337IHP/FJX7457IHP)

Takklimaanlegget har følgende tilleggsfunksjoner:

Tilleggsfunksjon	Displaymelding	Beskrivelse
Timer		Takklimaanlegget slås på ved et innstilt tidspunkt.
		Takklimaanlegget slås av ved et innstilt tidspunkt.
		Takklimaanlegget slås på og av igjen til innstilte tidspunkter.
Sleep		Sleep-funksjonen reduserer viftehastigheten og kompressorhastigheten for å redusere støynivåene for å legge til rette for en komfortabel søvn.
I Feel		Fjernkontrollen måler romtemperaturen og overfører denne målingen til takklimaanlegget hvert 10 min. Takklimaanlegget tilpasser målverdien til denne målingen.
Soft start		<b>Ikke FJX4233EEH:</b> Spisstrømmen som kompressorstarten produserer, reduseres av Soft start-funksjonen. Hvisen generator benyttes som spenningsforsyning, vil ikke generatoren bli overbelastet.

## 8 Før første gangs bruk

### Kontroll før igangsetting

Før du slår på takklimaanlegget må du passe på følgende:

1. Sjekk om forsyningsspenningen og frekvensen korresponderer til verdiene spesifisert i Tekniske spesifikasjoner på side 271.
2. Forsikre deg om at både luftinntaksåpningene og luftedysene er åpne. Alle luftegitre må alltid holdes fri for å sikre at takklimaanlegget kan gå med maksimal effekt.

### Forberede fjernkontrollen (kun FreshJet FJX4233EEH/FJX4333E(EH)/FJX7333IHP/FJX7337IHP/FJX7457IHP)

3. Sett inn batteriene (Bytte batterier i fjernkontrollen på side 264).

### Stille inn klokkeslett (kun FreshJet FJX4233EEH/FJX4333E(EH)/FJX7333IHP/FJX7337IHP/FJX7457IHP)

4. Stille inn aktuelt klokkeslett (Stille inn aktuelt klokkeslett på side 261).

## 9 Betjening

### 9.1 Råd om bedre bruk

Følgende råd vil optimere ytelsen til takklimaanlegget:

- Forbedre varmeisolasjonen i kjøretøyet ved å tette åpninger og dekke til vinduene med reflekterende rullegardiner eller gardiner.
- Velg egnet temperatur og viftehastighet.
- Juster luftdysene på fornuftig vis.
- Pass på at luftdysene og luftinntaksåpningene ikke er tildekket av kluter, papir og andre gjenstander.

- **Kun FreshJet FJX4233EEH/FJX4333E(EH)/FJX7333IHP/FJX7337IHP/FJX7457IHP:** Hvis kjøretøyet har vært utsatt for direkte sollys over lengre tid: Betjen takklimaenlegget i "Ventilasjon"-modus (☁️) med vinduene åpne en stund før du bytter til "Kjøling"-modus (❄️).
- **Kun FreshJet FJX4233EEH/FJX4333E(EH)/FJX7333IHP/FJX7337IHP/FJX7457IHP:** Unngå å åpne dører og vinduer så godt det lar seg gjøre i "Kjøling"-modus (❄️).

## 9.2 Grunnleggende betjeningsanvisninger

Takklimaenlegget FreshJet FJX4233M har tre driftsmåter:

Driftsmåte	Beskrivelse
Av	Takklimaenlegget er slått av.
Kjøling	Takklimaenlegget kjøler ned inne.
Ventilasjon	Takklimaenlegget sirkulerer luften uten å kjøle.

Takklimaenlegg FreshJet FJX4233EEH/FJX4333E(EH)/FJX7333IHP/FJX7337IHP/FJX7457IHP har to driftsmåter:

Driftsmåte	Beskrivelse
Standby	Takklimaenlegget er klart til bruk og kan slås på med fjernkontrollen. Omgivelseslysene er tilgjengelige. Fjernkontrollen er også i standby, men du kan slå på fjernkontrollen uavhengig av takklimaenlegget.
På	Takklimaenlegget klimatiserer kjøretøyet innvendig.

## 9.3 Dometic FJX4233M

Informasjonen som er gitt i dette kapitlet, er kun gyldig for takklimaenlegg FreshJet FJX4233M.

### 9.3.1 Slå takklimaenlegget av og på

Takklimaenlegget har to klimamoduser:





- Ventilasjon-modus (☁️)
- Kjøling-modus (❄️)



**Merk** Før du bytter fra ventilasjonsdrift til kjøle-drift eller omvendt, må du vente i minst 30 s. Eller vil koplingsstrømmen eventuelt føre til at sikringen går.

Hver modus har tre innstillinger:

- ..: Lav
- ...: Middels
- ....: Høy

- > For å slå på dreier du -knappen til posisjonen Ventilasjon-modus () eller posisjonen Kjøling-modus () og velger ønsket innstilling.
- ✓ Takklimaanlegget er slått på og drives med verdiene som ble innstilt før avslåingen.
- > For å slå av dreier du -knappen til posisjon 0.

### 9.3.2 Temperaturinnstilling

- > Drei -knappen til ønsket posisjon. Det å dreie knappen med urviseren innebærer en kaldere temperatur.
- ✓ Temperaturen er stilt inn på takklimaanlegget.

## 9.4 FreshJet FJX4233EEH/FJX4333E(EH)/FJX7333IHP/FJX7337IHP/FJX7457IHP

Informasjonen som er gitt i dette kapitlet, er kun gyldig for takklimaanlegg FreshJet FJX4233EEH/FJX4333E(EH)/FJX7333IHP/FJX7337IHP/FJX7457IHP.



### 9.4.1 Med fjernkontrollen

Ta hensyn til følgende tips ved bruk av fjernkontrollen:

- Pek fjernkontrollen mot den infrarøde mottakeren på betjeningspanelet.
- De korresponderende innstillinger og verdier overføres direkte til takklimaanlegget når du trykker på en knapp.
- Takklimaanlegget bekrefter mottak av dataene med et pip.
- Verdiene øker eller synker raskere dersom du trykker på og holder inne + eller – knappene.
- I standbymodus er også fjernkontrollens display inaktivt. Du kan koble fjernkontrollen til standby uavhengig av takklimaanlegget.
- > For å koble bare fjernkontrollen til eller fra standbymodus, må du trykke på -knappen mens du ikke peker på IR-mottakeren til betjeningspanelet.

### 9.4.2 Slå takklimaanlegget av og sette det i standby

 **Merk** Hvis takklimaanlegget slås på, drives det med verdiene som ble innstilt før omkobling til standby. Takklimaanlegget kan bare slås av ved å kutte strømforsyningen.









- > Trykk på -knappen på fjernkontrollen eller -knappen på betjeningspanelet, for å slå takklimaanlegget på eller sette det i standby.



### 9.4.3 Velge klimamodus

- > Velg ønsket klimaanleggsmodus ved å bruke MODE-tasten (Klimaanleggsmoduser (kun FJX4233EEH/FJX4333E(EH)/FJX7333IHP/FJX7337IHP/FJX7457IHP) på side 257).
- ✓ Takklimaanlegget bekrefter mottak av verdiene med et pip. Takklimaanlegget kobles til valgt klimamodus.

### 9.4.4 Velge viftehastighet manuelt

I alle moduser, med unntak av automatisk modus ( **A** ) og avfuktingsmodus (  ), kan viftehastigheten velges manuelt.

Displaymelding	Beskrivelse
 	Lavt viftenivå
 	Middels viftenivå
 	Høyt viftetrinn.
 	Turboviftetrinn.
 <b>A</b>	Automatisk modus (viftehastigheten er justert basert på omgivelsestemperaturen).

- > Trykk på -knappen på fjernkontrollen eller -knappen på betjeningspanelet for å velge ønsket viftehastighet.
- ✓ Takklimaanlegget bekrefter mottak av verdiene med et pip.

Den nye viftehastigheten er stilt inn.

### 9.4.5 Temperaturinnstilling

I modusene Automatisk ( **A** ), Kjøle (  ), Varme (  ) og Avfukting (  ), kan du spesifisere en temperatur mellom 16 °C og 31 °C.

- > Bruk + eller –-knappen på fjernkontrollen for å stille inn ønsket temperatur.
- ✓ Takklimaanlegget bekrefter mottak av verdiene med et høyt pip. Temperaturen er stilt inn på takklimaanlegget.

### 9.4.6 Stille inn aktuelt klokkeslett

For å programmere timeren trenger fjernkontrollen riktig klokkeslett. Klokkeslettet vises i displayet på fjernkontrollen.

1. Trykk på -knappen og hold den inne for å komme til modusen for innstilling av klokkeslett.
- ✓ Klokkeslettet blinker i displayet på fjernkontrollen.
2. Still inn aktuelt klokkeslett med + eller -. Trykk på og hold inne knappene + eller – i mer enn 2 s for å øke eller redusere klokkeslettet raskere.
3. Trykk på SET for å bekrefte klokkeslettet.

### 9.4.7 Programmere timeren

Med timerfunksjonen kan du stille inn et ønsket tidsrom for klimatiseringen. Du kan angi enten innkoblingstidspunkt eller utkoblingstidspunkt, eller begge deler.

Timerfunksjonen stilles inn via fjernkontrollen.



**Merk** Hvis man ikke trykker på noen knapp på fjernkontrollen i løpet av 15 s under timerprogrammeringen, går fjernkontrollen tilbake til utgangsmodus.







- > Still inn **innkoblingstimeren** som følger:
  - a) Velg ønsket klimaanleggsmodus og alle nødvendige verdier (for eksempel temperaturen).
  - b) Sett om nødvendig takklimaenlegget i standbymodus.  
Innkoblingstimeren kan bare stilles inn hvis takklimaenlegget befinner seg i **standby**.
  - c) Trykk på knappen  én gang.
  - ✓  -symbolet blinker på fjernkontrollens display.
  - d) Bruk knappen + eller – for å stille inn klokkeslettet for når takklimaenlegget skal slå seg på.
  - e) Trykk på -knappen.  
Innkoblingstimeren er stilt inn. Takklimaenlegget blir slått på i valgt klimaanleggsmodus til spesifisert tid.
- > Still inn **utkoblingstimeren** som følger:
  - a) Slå om nødvendig på takklimaenlegget.  
Utkoblingstimeren kan bare stilles inn når takklimaenlegget er slått **på**.
  - b) Trykk to ganger på -knappen.
  - ✓  -symbolet blinker på fjernkontrollens display.
  - c) Bruk knappen + eller – for å stille inn klokkeslettet for når takklimaenlegget skal settes i standbymodus.
  - d) Trykk på -knappen.  
Utkoblingstimeren er stilt inn. Takklimaenlegget settes i standby ved det innstilte tidspunktet.
- > Still inn **innkoblingstimeren** og **utkoblingstimeren** som følger:
  - a) Velg ønsket klimaanleggsmodus og alle nødvendige verdier (for eksempel temperaturen).
  - b) Trykk tre ganger på -knappen.
  - ✓   -symbolet vises i displayet på fjernkontrollen. PÅ-symbolet blinker.
  - c) Bruk knappen + eller – for å stille inn klokkeslettet for når takklimaenlegget skal slå seg på.
  - d) Trykk på -knappen.
  - ✓ **OFF**-symbolet blinker.
  - e) Bruk knappen + eller – for å stille inn klokkeslettet for når takklimaenlegget skal settes i standbymodus.
  - f) Trykk på -knappen.  
✓ Innkoblings- og utkoblingstidspunktene er stilt inn. Takklimaenlegget blir slått på for det spesifiserte tidsrommet,
- > For å **slette** den forhåndsinnstilte timeren trykker du på -knappen én gang.
- ✓   -symbolene forsvinner. De forhåndsinnstilte verdiene forkastes.

#### 9.4.8 Stille inn Sleep-funksjonen

Sleep-funksjonen er bare tilgjengelig i modusene Kjøling (❄️) eller Oppvarming (🔥).

Sleep-funksjonen begrenser viftehastigheten til et lavere nivå for å redusere støyen og gjøre det lettere å sove.

**Kun FJX7333IHP/FJX7337IHP/FJX7457IHP:** Sleep-funksjonen begrenser i tillegg kompressorhastigheten.

- > Gå fram på følgende måte for å aktivere Sleep-funksjonen:
  - a) Still inn ønsket temperatur (Temperaturinnstilling på side 261).
  - b) Trykk på -knappen på fjernkontrollen eller -knappen på betjeningspanelet.
- ✓ Symbolet  vises i fjernkontrollens display. Sleep-funksjon er aktivert.
  - > For å deaktivere sleep-funksjonen trykker du på - eller -knappen på fjernkontrollen eller -knappen på betjeningspanelet.
- ✓ Symbolet  forsvinner fra fjernkontrollens display. Sleep-funksjon er deaktivert.

### 9.4.9 Aktivere "I feel"-funksjonen

I denne funksjonen måler fjernkontrollen romtemperaturen og overfører denne målingen til takklimaenlegget hvert 10. minutt. Takklimaenlegget tilpasser målverdien til denne målingen. Funksjonen "I feel" er bare aktiv når temperaturen ligger mellom +18 °C og +29 °C.

Fjernkontrollen må ikke være i et område i rommet som er betydelig varmere eller kaldere enn gjennomsnittlig romtemperatur. Den må f.eks. ikke ligge i solen eller foran takklimaenlegget.

Hvis temperaturen stiger over +29 °C eller synker under +18 °C, er "I feel"-funksjonen deaktivert. -symbolet blinker tre ganger i displayet og slås så av.

1. Trykk på knappen.
- ✓ Funksjonen "I feel" er aktivert.

-symbolet vises i displayet.

2. Plasser fjernkontrollen slik at den peker mot IR-mottakeren på betjeningspanelet. Ellers kan ikke verdien sendes til takklimaenlegget.







### 9.4.10 Betjene omgivelseslysene



**ADVARSEL! Fare for personskader** Loven forbyr å bruke eksternt lys under kjøring av kjøretøyet.

-knappen på fjernkontrollen er aktiv selv om fjernkontrollen er slått av.

#### Kun FreshJet FJX4233EEH/FJX4333E(EH)/FJX7333IHP/FJX7337IHP/FJX7457IHP:

- > For å slå interne lys på eller av, trykker du på -knappen på fjernkontrollen eller betjeningspanelet.
- ✓ -symbolet blinker en gang i displayet på fjernkontrollen dersom de interne lysene er slått på.
  - > Gå frem på følgende måte for å dimme de interne lysene:
    - a) Trykk på -knappen på fjernkontrollen eller på betjeningspanelet i 3 s.
    - b) Når du trykker på -knappen på fjernkontrollen: Trykk på -knappen for å dimme det interne lyset mellom 50 % og 100 %.
    - c) Når du trykker på -knappen på betjeningspanelet: Det interne lysets lysstyrke veksler mellom 50 % og 100 %. Slipp opp -knappen når den ønskede lysstyrken er nådd.

#### Kun FreshJet FJX7333IHP/FJX7337IHP/FJX7457IHP:

- > For å slå de eksterne lysene på eller av, trykker du på -knappen på betjeningspanelet.

### 9.4.11 Bytte batterier i fjernkontrollen



**Merk** Displayet på fjernkontrollen kan fortsatt være lyst selv om batteriene begynner å bli tomme. Bytt batteriene hvis fjernkontrollen indikerer lavt batterinivå.

> Bytt batteriene som vist.

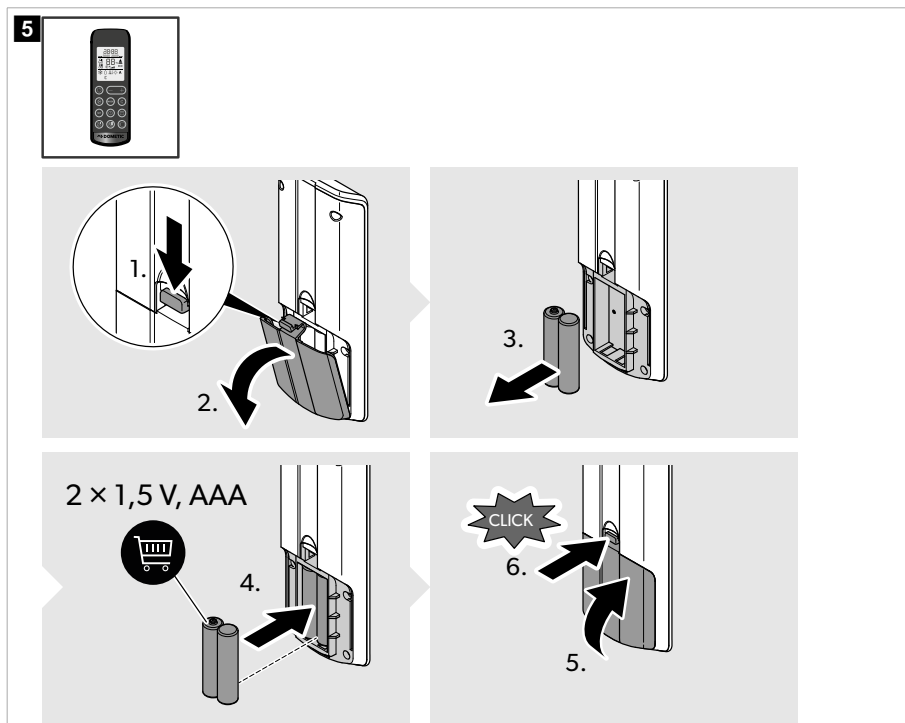

✓ Displayet viser alle symboler i 5 s.



Bevar miljøet! Batterier hører ikke hjemme i husholdningsavfallet. Lever defekte eller brukte batterier enten til forhandleren eller på en oppsamlingsstasjon.

### 9.5 Regulere lufttilførselen inne i kjøretøyet

Luftstrømmen kan justeres mot taket eller gulvet.



- > Drei lamellene i luftdysene uavhengig av hverandre i ønsket retning.

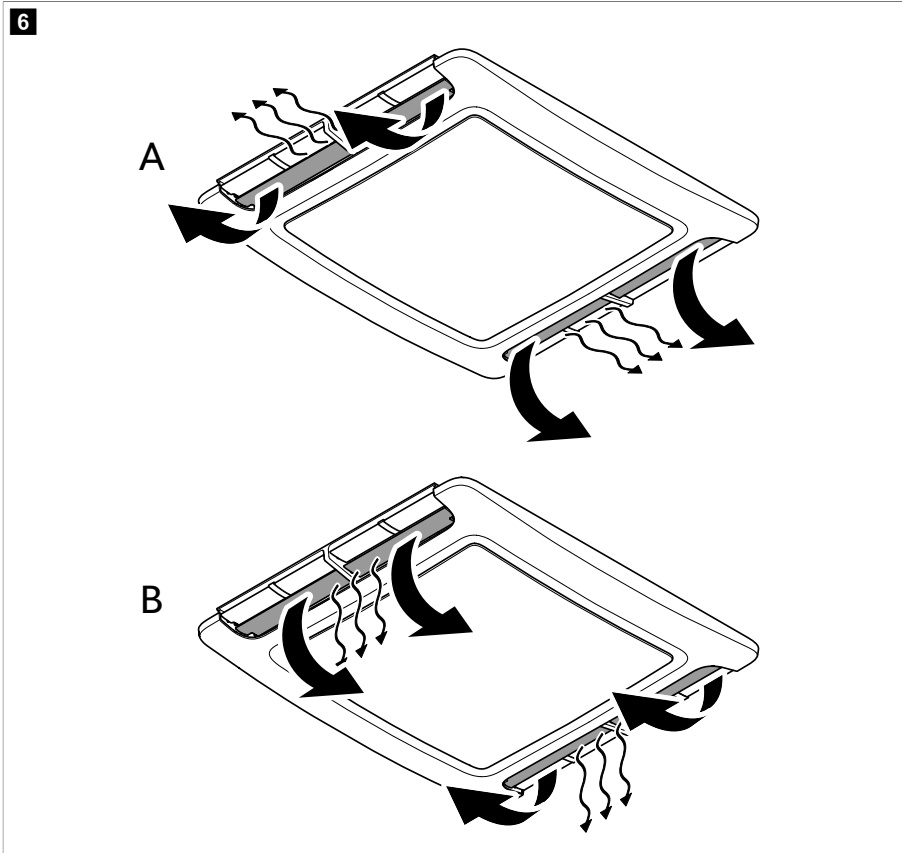

## 10 Rengjøring av takklimaenlegget



### PASS PÅ! Fare for skader

- Ikke ty til andre midler enn de som er anbefalt av produsenten til opptiningsprosessen eller rengjøringen.
- Ikke rengjør takklimaenlegget med høytrykksspyler. Takklimaenlegget kan ta skade av vann som trenger inn.
- Ikke bruk skarpe eller harde gjenstander eller rengjøringsmidler til rengjøring, da de kan skade takklimaenlegget.
- Ikke bruk bensin, diesel eller løsemidler.

1. Fjern regelmessig løv og annet smuss fra luftinntaket og luftlamellene på takklimaenlegget. Ikke ødelegg luftlamellene under dette arbeidet.

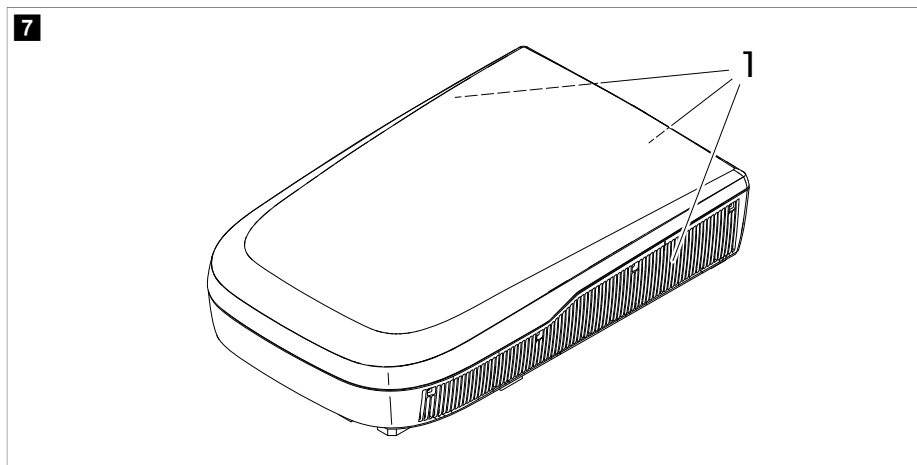

2. Rengjør kapslingene til takklimaenlegget og luftfordelingsboksen fra tid til annen med en fuktig klut. Bruk kun vann med et mildt rengjøringsmiddel.
3. **Kun FreshJet FJX4233EEH/FJX4333E(EH)/FJX7333IHP/FJX7337IHP/FJX7457IHP:** Rengjør fjernkontrollen fra tid til annen med en lett fuktig klut. Rengjør displayet med en rengjøringsklut for briller.
4. **Kun FreshJet FJX4233EEH/FJX4333E(EH)/FJX7333IHP/FJX7337IHP/FJX7457IHP** Rengjør luftfordelingsboksen fra tid til annen med en mild blanding av såpe og varmt vann. Displayet er av akryl og kan skades av enkelte vanlige husholdningskemikalier som kjemiske rengjøringsmidler, vinduspussmidler, alkohol, visse tensider, organiske løsemidler og mykningsmidler.

## 11 Vedlikehold

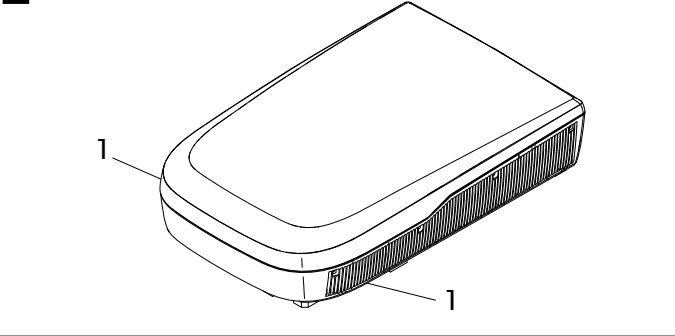
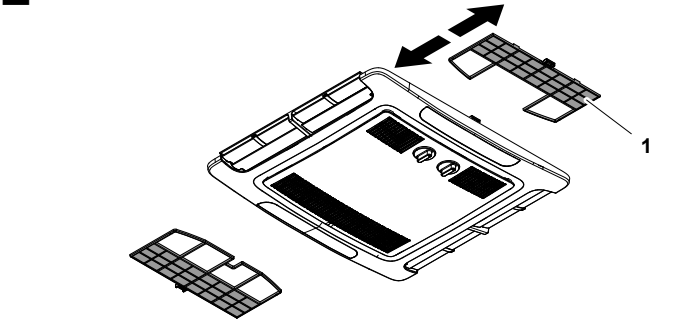

**ADVARSEL! Fare for personskader** Annet vedlikeholdsarbeid ut over de temaene som er beskrevet her, må kun utføres av fagfolk som kjenner til farene ved håndtering av kjølemidler og klimaenlegg, og som er kjent med gjeldende forskrifter.

Intervall	Kontroll/vedlikehold
Regelmessig	<p data-bbox="333 188 964 231">Sjekk om kondensvannutløpskanalene (1) på siden av takklimaenlegget er rene og kondensvannet kan slippe ut.</p> <div data-bbox="333 247 1016 616"><p data-bbox="341 252 367 284"><b>8</b></p></div>
Regelmessig (FreshJet FJX4233M)	<p data-bbox="333 643 594 663">Rengjør filteret til luftutløpsenheten.</p> <div data-bbox="333 679 1016 1046"><p data-bbox="341 684 367 716"><b>9</b></p></div> <ol data-bbox="348 1062 804 1126" style="list-style-type: none"><li>1. Ta ut filteret (1).</li><li>2. Rengjør filteret (1) med et rengjøringsmiddel og la det tørke.</li><li>3. Sett inn det tørre filteret (1) igjen.</li></ol>

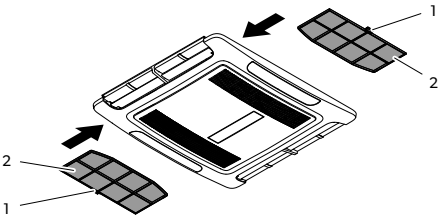
Intervall	Kontroll/vedlikehold
Regelmessig (Fresh-Jet FJX4233EEH/ FJX4333E(EH)/FJX7333IHP/ FJX7337IHP/FJX7457IHP)	<ul style="list-style-type: none"> <li>Rengjør filteret til luftutløpsenheten.</li> </ul> <div data-bbox="367 225 1016 528" style="border: 1px solid black; padding: 10px;"> <p><b>10</b></p>  </div> <ol style="list-style-type: none"> <li>Sett en flat skrutrekker eller kniv inn i håndtaket (1) for å trekke filterne (2) ut såvidt.</li> <li>Fjern filterne for hånd.</li> <li>Rengjør filterne med et rengjøringsmiddel og la dem tørke.</li> <li>Skyv de tørre filterne på plass igjen. fig. 10 på side 268</li> </ol> <ul style="list-style-type: none"> <li>Lever varmeveksleren i takklimaenlegget inn til et spesialistfirma for vedlikehold.</li> </ul>
En gang i året	<ul style="list-style-type: none"> <li>Sjekk tetningene mellom takklimaenlegget og taket på kjøretøyet med tanke på sprekker og andre skader.</li> <li>Sjekk om festeboltene er strammet til korrekt tiltrekingsmoment (2.5 Nm ± 0.3 Nm) og korriger ved behov.</li> </ul>

## 12 Feilretting

Problem	Mulig årsak	Løsningsforslag
Kjøler ikke bra	Takklimaenlegget er ikke stilt inn på kjøling.	Still inn takklimaenlegget på kjøling.
	Omgivelsestemperaturen er høyere enn 52 °C.	Takklimaenlegget er kun beregnet på en omgivelsestemperatur på opptil 52 °C.
	Innstilt temperatur er høyere enn romtemperaturen.	Velg en lavere temperatur.
	Omgivelsestemperaturen er lavere enn 16 °C.	Takklimaenlegget er konstruert for kjøling kun ved omgivelsestemperaturer over 16 °C.
	En av temperaturfølerne er defekt.	Kontakt et autorisert serviceverksted eller Dometic.
	Fordamperviften er skadd.	Kontakt et autorisert serviceverksted eller Dometic.
	Kondensatorviften er defekt.	Kontakt et autorisert serviceverksted eller Dometic.

Problem	Mulig årsak	Løsningsforslag
<b>Kun FreshJet FJX4233EEH/ FJX4333E(EH)/FJX7333IHP/ FJX7337IHP/FJX7457IHP:</b> Varmter ikke bra	Takklimaanlegget er ikke stilt inn på oppvarming.	Stil inn takklimaanlegget på oppvarming.
	Omgivelsestemperaturen er lavere enn $-2\text{ }^{\circ}\text{C}$ .	Takklimaanlegget er konstruert for omgivelsestemperaturer over $-2\text{ }^{\circ}\text{C}$ .
	Innstilt temperatur er lavere enn romtemperaturen.	Velg en høyere temperatur.
	En av temperaturfølerne er defekt.	Kontakt et autorisert serviceverksted eller Dometic.
	Fordamperviften er skadd.	Kontakt et autorisert serviceverksted eller Dometic.
Lavt luftutslipp	Luftinntaksåpningene er blokkerte eller sperret.	Fjern løv og annet smuss fra luftlanelene på takklimaanlegget.
	Viften er defekt.	Kontakt et autorisert serviceverksted eller Dometic.
Det kommer vann inn i kjøretøyet	Avløpsåpningene for kondensvann er tilstoppet.	Rengjør vannavløpsåpningen for kondensvann.
	Tetningene er defekte.	Kontakt et autorisert serviceverksted eller Dometic.
Takklimaanlegget slår seg ikke på.	Ingen strømforsyning tilkoblet.	Kontroller strømtilførselen.
	Spenningen er for lav ( $< 200\text{ V}$ ).	Kontakt et autorisert serviceverksted eller Dometic.
	Spenningsomformeren er defekt.	Kontakt et autorisert serviceverksted eller Dometic.
	En av temperaturfølerne er defekt.	Kontakt et autorisert serviceverksted eller Dometic.
	Den elektriske sikringen til strømforsyningen er for lav.	Kontakt et autorisert serviceverksted eller Dometic.
Takklimaanlegget slår seg ikke av.	En av temperaturfølerne er defekt.	Kontakt et autorisert serviceverksted eller Dometic.
	Den elektriske sikringen til strømforsyningen er for lav.	Kontakt et autorisert serviceverksted eller Dometic.
<b>Kun FreshJet FJX4233EEH/ FJX4333E(EH)/FJX7333IHP/ FJX7337IHP/FJX7457IHP:</b> Takklimaanlegget slår seg av hele tiden.	Isføleren er utløst.	Utetemperaturen er for lav eller alle luftdyser er lukket.
Displayet viser: P0	For høy temperatur eller strømstyrke på IPM-modul	Kontakt et autorisert serviceverksted eller Dometic.
Displayet viser: P1	Underspenningsvern	Kontakt et autorisert serviceverksted eller Dometic.

Problem	Mulig årsak	Løsningsforslag
Displayet viser: P2	Enhet vekselstrøm overstrømbeskyttelse	Kontakt et autorisert serviceverksted eller Dometic.
Displayet viser: P4	Utløpsrør overopphetingsbeskyttelse	Kontakt et autorisert serviceverksted eller Dometic.
Displayet viser: P5	Fordamperspolebeskyttelse ("kjøling"-modus)	Kontakt et autorisert serviceverksted eller Dometic.
Displayet viser: P6	Kondensatorspolebeskyttelse ("kjøling"-modus)	Kontakt et autorisert serviceverksted eller Dometic.
Displayet viser: P7	Fordamperspolebeskyttelse ("oppvarming"-modus)	Kontakt et autorisert serviceverksted eller Dometic.
Displayet viser: P9	Kompressordrev unormalt eller kompressor starter ikke	Kontakt et autorisert serviceverksted eller Dometic.
Displayet viser: E0	Kommunikasjonssvikt	Kontakt et autorisert serviceverksted eller Dometic.
Displayet viser: E1	Feil på romtemperatursensor	Kontakt et autorisert serviceverksted eller Dometic.
Displayet viser: E2	Fordamperspole temperatursensorfeil	Kontakt et autorisert serviceverksted eller Dometic.
Displayet viser: E3	Kondensatorspole temperatursensorfeil	Kontakt et autorisert serviceverksted eller Dometic.
Displayet viser: E7	Feil på sensor for utendørs temperatur	Kontakt et autorisert serviceverksted eller Dometic.
Displayet viser: E8	Feil på temperatursensor for utløpsrør	Kontakt et autorisert serviceverksted eller Dometic.
Displayet viser: E9	Feil på kompressordrev eller IPM-modul	Kontakt et autorisert serviceverksted eller Dometic.
Displayet viser: EA	Strømsensorfeil	Kontakt et autorisert serviceverksted eller Dometic.
Displayet viser: EE	Feil på utendørs EEPROM	Kontakt et autorisert serviceverksted eller Dometic.
Displayet viser: EL	LIN-buss/CI-buss kommunikasjonssvikt	Kontakt et autorisert serviceverksted eller Dometic.

## 13 Avfallshåndtering



Lever emballasje til resirkulering så langt det er mulig. For å kaste produktet endelig ta kontakt med det lokale resirkuleringscenteret eller faghandler om hvordan du kan gjøre dette i overensstemmelse med gjeldende avfallshåndteringsforskrifter.



Bevar miljøet! Batterier hører ikke hjemme i husholdningsavfallet. Lever defekte eller brukte batterier enten til forhandleren eller på en oppsamlingsstasjon.

## 14 Garanti

Lovmessig garantitid gjelder. Hvis produktet er defekt: Ta kontakt med produsentens filial (se [dometic.com/dealer](http://dometic.com/dealer)) eller forhandler i ditt land.

Ved henvendelser vedrørende reparasjon eller garanti, må du sende med følgende dokumentasjon:

- Kopi av kvitteringen med kjøpsdato
- Årsak til reklamasjonen eller beskrivelse av feilen

Vær oppmerksom på at reparasjoner som utføres selv, eller som ikke utføres på en profesjonell måte, kan gå ut over sikkerheten og føre til at garantien blir ugyldig.

## 15 Tekniske spesifikasjoner

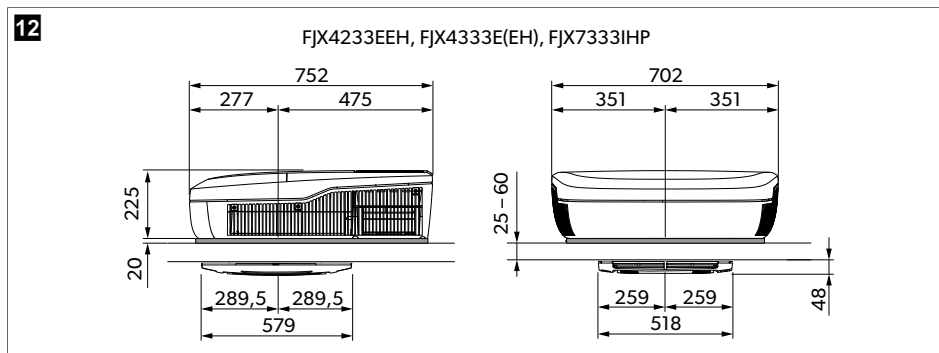
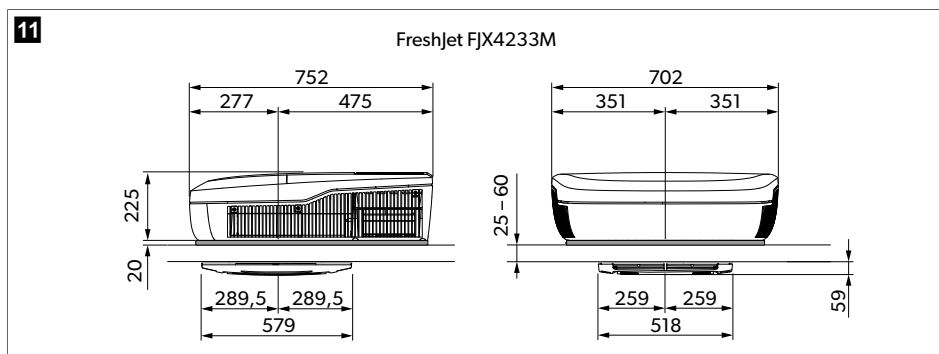

13

FreshJet FJX7337IHP

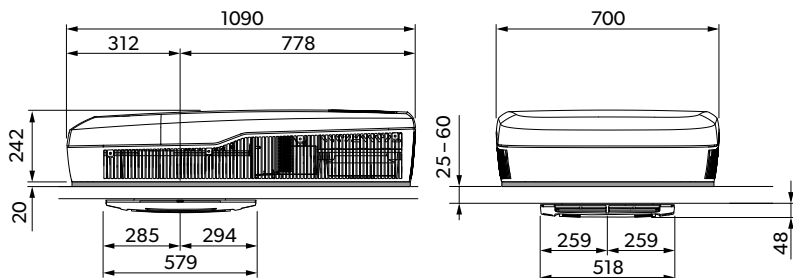

14

FreshJet FJX7457IHP

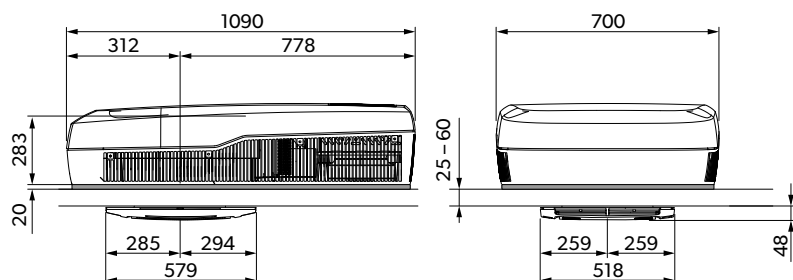



Inneholder fluoriserte drivhusgasser. Hermetisk tett utstyr.

	<b>FreshJet FJX4233M</b>
Kjøleeffekt iht. ISO 5151:	1500 W
Vekselinngangsspenning:	220 V ... 240 V / 50 Hz
Nominell strøm, kjøling:	< 3.3 A
Nødvendig sikringsstørrelse:	4 A
Driftstemperaturområde:	- 2 °C ... 52 °C
Kjølemiddel:	R410a
Kjølemiddelmengde:	380 g
CO <sub>2</sub> -ekvivalent:	0.793 t
GWP-verdi:	2088
Beskyttelsesklasse (hustakenhet):	IPX4



	<b>FreshJet FJX4233M</b>
Støynivå (øverste vifteinnstilling)	< 70 dB(A)
Foreslått maks. kjøretøylengde (med isolerte vegger):	< 5 m
Mål L x B x H:	fig. <b>11</b> på side 271
Vekt:	< 30 kg
Inspeksjon/sertifisering:	

	<b>FreshJet FJX4233EEH</b>	<b>FreshJet FJX4333EEH</b>	<b>FreshJet FJX4333E</b>
Kjøleeffekt iht. ISO 5151:	1700 W	2200 W	2200 W
Varmeeffekt iht. ISO 5151:	800 W	1000 W	-
Vekselningangsspenning:	220 V ... 240 V / 50 Hz		
Nominell strøm, kjøling:	3.6 A	4.8 A	4.8 A
Nominell strøm, oppvarming:	< 5.2 A	< 5.2 A	-
Nødvendig sikringsstørrelse:	4 A	5 A	6 A
Driftstemperaturområde:	- 2 °C ... 52 °C		
Kjølemiddel:	R32		
Kjølemiddelmengde:	320 g	360 g	360 g
CO <sub>2</sub> -ekvivalent:	0.216 t	0.243 t	0.243 t
GWP-verdi:	675		
Beskyttelsesklasse (hustakenhet):	IPX4		
Støynivå (øverste vifteinnstilling)	< 70 dB(A)		
Foreslått maks. kjøretøylengde (med isolerte vegger):	< 6 m	< 7 m	< 7 m
Mål L x B x H:	fig. <b>12</b> på side 271		
Vekt:	< 30 kg	< 30 kg	< 30 kg

	FreshJet FJX4233EEH	FreshJet FJX4333EEH	FreshJet FJX4333E
Inspeksjon/sertifisering:			
	FreshJet FJX7333IHP	FreshJet FJX7337IHP	FreshJet FJX7457IHP
Kjøleeffekt iht. ISO 5151:	2200 W	3000 W	3500 W
Varmeeffekt iht. ISO 5151:	2000 W	2500 W	3000 W
Vekselinngangsspenning:	220 V ... 240 V / 50 Hz ... 60 Hz	220 V ... 240 V / 50 Hz ... 60 Hz	220 V ... 240 V / 50 Hz ... 60 Hz
Nominell strøm, kjøling:	< 7,5 A	< 7,5 A	< 7,5 A
Nominell strøm, oppvarming:	< 6,1 A	< 6,1 A	< 6,1 A
Nødvendig sikringsstørrelse:	6 A	6 A	6 A
Driftstemperaturområde:	- 2 °C ... 52 °C	- 2 °C ... 52 °C	- 2 °C ... 52 °C
Kjølemiddel:	R32	R32	R32
Kjølemiddelmengde:	420 g	480 g	650 g
CO <sub>2</sub> -ekvivalent:	0.2835 t	0.3240 t	0.43875 t
GWP-verdi:	675		
Beskyttelsesklasse (hustakenhet):	IPX4		
Støynivå (øverste vifteinnstilling)	< 70 dB(A)		
Foreslått maks. kjøretøylengde (med isolerte vegger):	< 7 m	< 7 m	> 8 m
Mål L x B x H:	fig. 12 på side 271	fig. 13 på side 272	fig. 14 på side 272
Vekt:	< 30 kg	< 35 kg	< 40 kg
Inspeksjon/sertifisering:			

## Finnish

1	Important notes.....	275
2	Symbolien selitykset.....	275
3	Turvallisuusohjeet.....	276
4	Käyttötarkoitus.....	277
5	Laitteen symbolien selitykset.....	278
6	Tekniset rajoitukset ja vaatimukset.....	278
7	Tekninen kuvaus.....	278
8	Ennen ensikäyttöä.....	284
9	Käyttö.....	284
10	Kattoilmastointilaitteen puhdistus.....	292
11	Huolto.....	292
12	Vianetsintä.....	294
13	Hävittäminen.....	297
14	Takuu.....	297
15	Tekniset tiedot.....	297

## 1 Important notes

Lue nämä ohjeet huolellisesti ja noudata kaikkia tämän tuotteen käyttöohjeissa annettuja ohjeita, määräyksiä ja varoituksia. Näin varmistat, että tuotteen asennus, käyttö ja huolto sujuu aina oikein. Näiden ohjeiden TÄYTYY jäädä tuotteen yhteyteen.

Käyttämällä tuotetta vahvistat lukeneesi kaikki ohjeet, määräykset ja varoitukset huolellisesti ja että ymmärrät ja hyväksyt tässä annetut ehdot. Sitoudut käyttämään tuotetta ainoastaan sen käyttötarkoitukseen ja ilmoitetuissa käyttökohteissa ja noudattaen tässä tuotteen käyttöohjeessa annettuja ohjeita, määräyksiä ja varoituksia sekä voimassa olevia lakeja ja määräyksiä. Tässä annettujen ohjeiden ja varoitusten lukematta ja noudattamatta jättäminen voi johtaa omaan tai muiden loukkaantumiseen, tuotteen vaurioitumiseen tai muun ympärillä olevan omaisuuden vaurioitumiseen. Tähän tuotteen käyttöohjeeseen, ohjeisiin, määräyksiin ja varoituksiin sekä ohaisdokumenteihin voidaan tehdä muutoksia ja niitä voidaan päivittää. Katso ajantasaiset tuotetiedot osoitteesta [documents.dometic.com](http://documents.dometic.com).

## 2 Symbolien selitykset



**VAARA!** Viittaa vaaralliseen tilanteeseen, joka johtaa kuolemaan tai vakavaan loukkaantumiseen, jos sitä ei vältetä.



**VAROITUS!** Viittaa vaaralliseen tilanteeseen, joka johtaa kuolemaan tai vakavaan loukkaantumiseen, jos sitä ei vältetä.



**HUOMIO!** Viittaavat vaaralliseen tilanteeseen, joka voi johtaa lievään tai kohtalaiseen loukkaantumiseen, jos ohjeita ei noudateta.



**HUOMAUTUS!** Viittaavat vaaralliseen tilanteeseen, joka voi johtaa lievään tai kohtalaiseen loukkaantumiseen, jos ohjeita ei noudateta.



**Ohje** Tuotteen käyttöä koskevia lisätietoja.

### 3 Turvallisuusohjeet



**VAROITUS! Näiden varoitusten noudattamatta jättäminen voi johtaa kuolemaan tai vakavaan vammaan.**

- **Sähkölaitteet eivät ole leluja.** Laitetta eivät saa käyttää sellaiset henkilöt (mukaan lukien lapset) joiden fyysiset, sensoriset tai henkiset kyvyt ovat rajoittuneet tai joilla ei ole tarvittavaa kokemusta ja tietoutta paitsi, jos he ovat valvonnan alaisina tai saaneet opastuksen.
- Lapsia tulisi valvoa sen varmistamiseksi, etteivät he leiki laitteella.
- Tätä laitetta voivat käyttää valvonnan alaisuudessa myös vähintään 8-vuotiaat lapset samoin kuin henkilöt, joiden fyysiset, aistinvaraiset tai henkiset kyvyt ovat rajoittuneet tai joilta puuttuu laitteen käytön vaatima kokemus tai tietämys, mikäli he ovat valvonnan alla tai heitä on opastettu käyttämään laitetta turvallisesti ja ymmärtämään laitteen käyttöön liittyvät riskit.
- Lapset eivät saa ilman valvontaa puhdistaa laitetta.
- Jokaisella jäähdytyskierron parissa työskentelevällä tai siihen tunkeutuvalla täytyy olla voimassa oleva, alan akkreditoitun arviointilaitoksen myöntämä todistus, joka osoittaa hänen olevan pätevä käsittelemään kylmäaineita turvallisesti alan tunnustetun arviointieritelmän mukaisesti.
- Huoltotyöt saa tehdä vain laitevalmistajan suositusten mukaisesti. Huolto- ja korjaustyöt, joihin vaaditaan toisen pätevä henkilön apua, täytyy tehdä syttyvien kylmäaineiden käyttöön kykenevän henkilön valvonnassa.
- Laitetta saa korjata vain pätevä ammattilainen, joka tuntee töihin liittyvät vaarat ja oleelliset määräykset. Virheellisesti suoritetuista korjauksista saattaa aiheutua huomattavia vaaroja. Käännä oman maasi huoltokililiikkeen puoleen, jos laite tarvitsee korjausta (katso [dometic.com/dealer](http://dometic.com/dealer)).
- Katkaise virransyöttö aina tuotteen parissa tehtävien töiden ajaksi.
- Laitetta on säilytettävä huonetilassa, jossa ei ole jatkuvasti toimivia syttymislähteitä kuten avoliekkiä, käytössä olevaa kaasulaitetta tai sähkölämmittintä.
- Älä tee laitteeseen reikiä äläkä polta sitä.
- Huomaa, että kylmäaineissa ei saa olla hajusteita.
- Älä käytä laitetta syttyvien nesteiden lähellä äläkä suljetuissa tiloissa.
- Huolehdi siitä, että syttyviä esineitä ei säilytetä ilmavirran ulostuloaukon alueella eikä asenneta tälle alueelle. Etäisyyden täytyy olla vähintään 50 cm.
- Pidä tuuletusaukot esteettöminä.
- Älä vahingoita kylmäainekiertoa.
- Kylmäainevuotoja ei missään tapauksessa saa etsiä tai paikantaa mahdollisten syttymislähteiden avulla. Älä käytä vuotolamppua (tai muuta avoliekkiin perustuvaa ilmaisinta).
- Kattoilmastointilaitteen saa asentaa ajoneuvoon, jonka lattiapinta-ala on yli 4 m<sup>2</sup>.



### **HUOMIO! Näiden varoitusten noudattamatta jättäminen voi johtaa vähäiseen tai kohtalaiseen vammaan.**

- Älä työnnä kättä ilmavirran ulostuloaukkoihin äläkä pane laitteeseen vieraita esineitä.
- Älä irrota laitteen yläkantta tulipalon sattuessa. Käytä sen sijaan hyväksytyjä sammutusvälineitä. Älä käytä sammuttamiseen vettä.
- Jos syöttöjohto on vaurioitunut, se täytyy vaaran välttämiseksi vaihdattaa valmistajalla tai valtuutetulla huoltopalvelulla taikka ammattilaisella, jolla on vastaava pätevyys.
- Mikäli laitteessa on ionisaattori, keskustele lääkärisi kanssa, jos sinulla on jokin sairaus. Ionisaattori voi tuottaa pieniä määriä otsonia (O3). Jos sinulla on keuhkotauti, astma, sydäntauti, hengityselinsairaus tai hengitysvaikeuksia, tai jos olet yliherkkä otsonille, tiedustele lääkäritäsi, onko sinun turvallista käyttää tätä laitetta.



### **HUOMAUTUS! Vahingonvaara**

- Älä käytä sulattamisen nopeuttamiseen tai puhdistamiseen muita kuin valmistajan suosittelemia keinoja.
- Laite täytyy varastoida siten, että mekaanisia vaurioita ei pääse syntymään.
- Älä tee laitteeseen mitään muutoksia!
- Älä missään tapauksessa aja pesulinjaan, kun laite on asennettuna.
- Jos jäähdytyskierrossa ilmenee vikaa, laite täytyy vaaran välttämiseksi tarkastuttaa ja korjauttaa valmistajalla tai valtuutetulla huoltopalvelulla taikka ammattilaisella, jolla on vastaava pätevyys.

## **4 Käyttötarkoitus**

Kattoilmastointilaitte FreshJet FJX on suunniteltu asennettavaksi vain matkailuvaunun tai asuntoauton katolle viilentämään sisätilaa.

Kattoilmastointilaitte **ei** sovellu juniin, taloihin eikä asuntoihin. Kattoilmastointilaitte **ei** sovi asennettavaksi rakennuskoneisiin, maatalouskoneisiin tai muihin vastaaviin työkoneisiin.

Tämä tuote soveltuu ainoastaan näissä ohjeissa ilmoitettuun käyttötarkoitukseen ja käyttökohteeseen.

Näistä ohjeista saat tuotteen asianmukaiseen asennukseen ja/tai käyttöön tarvittavat tiedot. Väärin tehdyn asennuksen ja/tai väärin käytettävän tai vääränlaisen huollon seurauksena laite ei toimi tyydyttävästi, ja se saattaa mennä epäkuntoon.

Valmistaja ei ota vastuuta tapaturmista tai tuotevaurioista, jotka johtuvat seuraavista:

- Väärin tehty asennus tai liitännä, ylijännite mukaan lukien
- Väärin tehty huolto tai muiden kuin valmistajalta saatavien alkuperäisten varaosien käyttö
- Tuotteeseen ilman valmistajan nimenomaista lupaa tehdyt muutokset
- Käyttö muuhun kuin tässä ohjeessa ilmoitettuun tarkoitukseen

Dometic pidättää itsellään oikeuden muutoksiin tuotteen ulkonäössä ja spesifikaatioissa.

## 5 Laitteen symbolien selitykset



Varoitus! Matalan palamistason materiaali.



Lue käyttöohje.



Lue huoltokirja.

## 6 Tekniset rajoitukset ja vaatimukset

Kattoilmastointilaitte on tarkoitettu ajoneuvoihin, joiden katon paksuus on 25 mm ... 60 mm. Kattoilmastointilaitteen toiminta taataan ympäristön lämpötilan ollessa välillä  $-2^{\circ}\text{C}$  ...  $52^{\circ}\text{C}$ . Kattoilmastointilaitte on tarkoitettu asennettavaksi  $\pm 10^{\circ}$  kulmaan vaakatasoon nähden. Kattoilmastointilaitteen suorituskyky voi heiketä, jos siihen kohdistuu voimakasta tärinää, esimerkiksi huonokuntoisilla teillä.

## 7 Tekninen kuvaus

Kattoilmastointilaitte FreshJet FJX4233M tuottaa ajoneuvon sisätilaan viileää ilmaa, jossa ei ole pölyä tai epäpuhtauksia ja josta voidaan poistaa kosteus.

Kattoilmastointilaitte FreshJet FJX4233EEH/FJX4333E(EH)/FJX7333IHP/FJX7337IHP/FJX7457IHP tuottaa ajoneuvon sisätilaan viileää tai lämmintä ilmaa, jossa ei ole pölyä tai epäpuhtauksia ja josta voidaan poistaa kosteus.

Kattoilmastointilaitte pystyy laskemaan ajoneuvon sisälämpötilan tietylle tasolle, joka riippuu ajoneuvotyypistä, ympäristölämpötilasta ja kattoilmastointilaitteen jäähdytyskapasiteetista. Jos ulkolämpötila on alle  $16^{\circ}\text{C}$ , kattoilmastointilaitte ei enää jäähdytä.

Kattoilmastointilaitetta käytetään seuraavilla käyttölaiteilla:

- Ohjauspaneeli

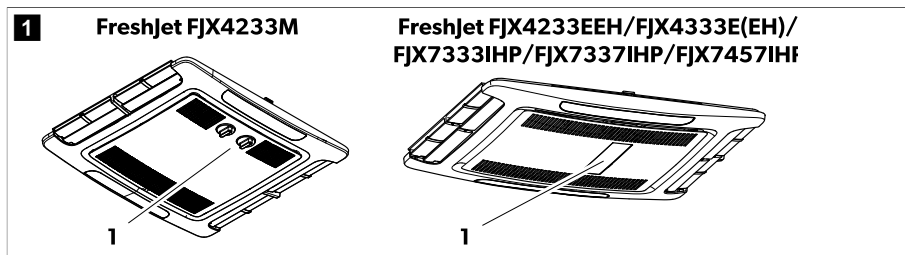

- Kaukosäädin (vain FJX4233EEH/FJX4333E(EH)/FJX7333IHP/FJX7337IHP/FJX7457IHP)

## 7.1 Malliluettelo

Seuraavasta taulukosta näet, mitä toimintoja missäkin mallissa on:

● Mallissa on kyseinen toiminto

○ Malliin voidaan lisätä kyseinen toiminto

	FJX4233M	FJX4233EEH	FJX4333EEH	FJX4333E	FJX7333IHP	FJX7337IHP	FJX7457IHP
Automaattinen		●	●	●	●	●	●
Jäähdytys	●	●	●	●	●	●	●
Lämmitys		●	●	○	●	●	●
Tuuletus	●	●	●	●	●	●	●
Kosteuden poisto		●	●	●	●	●	●
Ilmanpuhdistin	○	●	●	○	●	●	●
ADB-valo		●	●	○	●	●	●
Ulkoinen valo					●	●	●
Ajastin		●	●	●	●	●	●
Sleep-toiminto		●	●	●	●	●	●
Pehmeä käynnistys			●	○	●	●	●

## 7.2 Ohjauspaneeli FreshJet FJX4233M

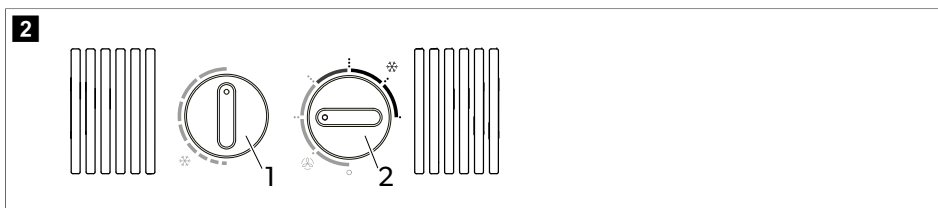

**Kier-  
tosäädin**

**Kuvaus**









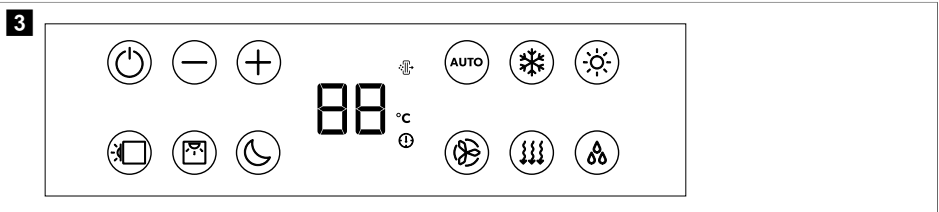



Valitsee lämpötilan. Kiertämällä myötäpäivään suurennat viilennysteho.





Kier- tosäädin	Kuvaus
	Kytkee kattoilmastointilaitteen päälle tai pois päältä ja valitsee ilman kierrätystehon Tuuletus-käyttötilassa (🌀) tai viilennystehon Jäähdytys-tilassa (❄️).

### 7.3 Ohjauspaneeli FreshJet FJX4233EEH/FJX4333E(EH)/FJX7333IHP/ FJX7337IHP/FJX7457IHP



Symboli	Kuvaus
	Kytkee kattoilmastointilaitteen päälle tai valmiustilaan.
	Suurentaa parhaillaan näkyvää arvoa.
	Pientää parhaillaan näkyvää arvoa.
	Suorittaa pariiliitännän bluetooth-/WLAN-yhteyden avulla, kun molempia painikkeita painetaan samanaikaisesti.
	Kytkee kattoyksikön ympäristövalot päälle ja pois päältä.
	Kytkee ilmanjakolaatikon ympäristövalot päälle ja pois päältä.
	Aktivoi sleep-toiminnon (Lisätoiminnot (vain FJX4233EEH/FJX4333E(EH)/FJX7333IHP/FJX7337IHP/ FJX7457IHP) sivulla 283).
	Näyttää säädetyn lämpötilan ja ilmaisee tuuletintason, kun tuuletinta säädetään.
	Ilmaisee, että ilmanpuhdistustila on aktivoituna.
<b>°C</b>	Ilmaisee, että lämpötila näytetään celsiusasteina.
	Ilmaisee, että ajastin on asetettu.
	Kytkee automaattikäytön päälle/pois (Ilmastointitilat (vain FJX4233EEH/FJX4333E(EH)/FJX7333IHP/ FJX7337IHP/FJX7457IHP) sivulla 283).



















Symboli	Kuvaus
	Kytkee jäähdytyskäytön päälle/pois (Ilmastointitilat (vain FJX4233EEH/FJX4333E(EH))/FJX7333IHP/FJX7337IHP/FJX7457IHP) sivulla 283).
	Kytkee lämmityskäytön päälle/pois (Ilmastointitilat (vain FJX4233EEH/FJX4333E(EH))/FJX7333IHP/FJX7337IHP/FJX7457IHP) sivulla 283).
	Säätää tuulettimen tehon asteikolla pieni, keskisuuri, suuri, turbo tai auto (näytetään ilmanjakolaatikon näytössä merkillä 1, 2, 3, 4 tai AA hetken aikaa vaihtamisen yhteydessä).
	Kytkee tuulettimien päälle/pois (Ilmastointitilat (vain FJX4233EEH/FJX4333E(EH))/FJX7333IHP/FJX7337IHP/FJX7457IHP) sivulla 283). Kierrättää ilmaa ilman lämmitystä tai jäähdytystä.
	Kytkee kosteudenpoistotilan päälle/pois (Ilmastointitilat (vain FJX4233EEH/FJX4333E(EH))/FJX7333IHP/FJX7337IHP/FJX7457IHP) sivulla 283).

## 7.4 Kaukosäädin FreshJet FJX4233EEH/FJX4333E(EH)/FJX7333IHP/FJX7337IHP/FJX7457IHP





Käyttö- ja näyttölaitteet kuva. **4** sivulla 281:

Painike	Kuvaus
—	<p><b>Näyttö</b></p> <p>Seuraavien näyttö:</p> <ul style="list-style-type: none"> <li>• Kellonaika</li> <li>• Valittu sisälämpötila (tavoitearvo), °C</li> <li>• Tilan todellinen lämpötila</li> <li>• Ilmastointitila</li> <li>• Tuuletinnopeus</li> <li>• Aktiivisten lisätoimintojen symbolit</li> <li>• Akun tila</li> </ul>
	Kytkee kattoilmastointilaitteen päälle tai standby-tilaan.
	Suurentaa parhaillaan näkyvää arvoa.
	Pientää parhaillaan näkyvää arvoa.
	Näyttää tuuletintehon (Tuuletintehon valitseminen manuaalisesti sivulla 287).
	Valitsee ilmastointitilan (Ilmastointitilat (vain FJX4233EEH/FJX4333E(EH)/FJX7333IHP/FJX7337IHP/FJX7457IHP) sivulla 283). Kyseinen symboli näkyy näytössä.
	Aktivoi sleep-toiminnon (Lisätoiminnot (vain FJX4233EEH/FJX4333E(EH)/FJX7333IHP/FJX7337IHP/FJX7457IHP) sivulla 283). Symboli  ilmestyy näyttöön.
	Vahvistaa ja tallentaa asetukset.
	Asettaa ajastimen ja kellonajan.
	Kytkee ilmanjakolaatikon ympäristövalot päälle ja pois päältä.
	Kertapainallus hakee näyttöön vallitsevan sisälämpötilan. Symboli  ilmestyy näyttöön. Tuplapainallus hakee näyttöön asetetun lämpötilan.
	Aktivoi I feel -toiminnon. Symboli  ilmestyy näyttöön. I feel -toiminnolla lämpötilan ohjearvoa sovitetaan 10 min välein kaukosäätimen mittaamaan todelliseen lämpötilaan.
	Kytkee kattoyksikön ympäristövalot päälle ja pois päältä.
	Näyttää, että kaukosäätimen paristot ovat tyhjä. Vaihda paristot (Kaukosäätimen paristojen vaihtaminen sivulla 290).
	Näyttää, että kaukosäädin lähettää arvoja kattoilmastointilaitteeseen.





## 7.5 Ilmastointitilat (vain FJX4233M)

Kattoilmastointilaitteessa on seuraavat ilmastointitilat:

Ilmastointitila	Näytettävät symbolit	Kuvaus
Jäähdytys		Kun olet asettanut lämpötilan ja tehnyt tuuletinasetukset, kattoilmastointilaite jäähdyyttää sisätilan tähän lämpötilaan.
Tuuletus		Kun olet tehnyt tuuletinasetukset, kattoilmastointilaite kierrättää ilmaa; lämmitystä tai jäähdyytystä ei käytetä.

## 7.6 Ilmastointitilat (vain FJX4233EEH/FJX4333E(EH)/FJX7333IHP/FJX7337IHP/FJX7457IHP)

Kattoilmastointilaitteessa on seuraavat ilmastointitilat:

Ilmastointitila	Näytettävät symbolit	Kuvaus
Automaattinen	<b>A</b>	Kun olet asettanut lämpötilan, kattoilmastointilaite tuottaa sisätilaan tämän lämpötilan lämmittämällä tai jäähdyttämällä ja sopivaa tuuletintehoa käyttämällä.
Jäähdytys		Kun olet asettanut lämpötilan ja tehnyt tuuletinasetukset, kattoilmastointilaite jäähdyyttää sisätilan tähän lämpötilaan.
Lämmitys		<b>Ei FJX4333E:</b> Kun olet asettanut lämpötilan ja tehnyt tuuletinasetukset, kattoilmastointilaite lämmittää sisätilan tähän lämpötilaan. Tuuletin käynnistyy vasta 2 min kuluttua (pienellä teholla) ja siirtyy asetettuun tehoon noin 5 min kuluttua (kun höyrystin on saavuttanut lämpötilan).
Tuuletus		Kun olet tehnyt tuuletinasetukset, kattoilmastointilaite kierrättää ilmaa; lämmitystä tai jäähdyytystä ei käytetä.
Ilmankosteuden poisto		Kattoilmastointilaite poistaa ilmankosteutta; sisätilaa ei lämmitetä eikä jäähdytetä, joten suhteellinen ilmankosteus vähenee.
Ilmanpuhdistin		<b>Ei FJX4333E:</b> Kattoilmastointilaite ionisoi ilmaa ja kerää siten ilmasta pölyä ja hiukkasia virukset ja bakteerit mukaan lukien.

## 7.7 Lisätoiminnot (vain FJX4233EEH/FJX4333E(EH)/FJX7333IHP/FJX7337IHP/FJX7457IHP)

Kattoilmastointilaitteessa on seuraavat lisätoiminnot:

Lisätoiminto	Näyttöilmoitus	Kuvaus
Ajastin		Kattoilmastointilaitte käynnistyy ennalta säädettyinä ajankohtana.
		Kattoilmastointilaitte kytkeytyy pois päältä ennalta säädettyinä ajankohtana.
		Kattoilmastointilaitte käynnistyy ja kytkeytyy pois päältä ennalta säädettyinä ajankohtana.
Sleep-toiminto		Sleep-toiminto pienentää tuulettimen ja kompressorin tehoa melutason pienentämiseksi ja nukkumisen mukavoittamiseksi.
I feel		Kaukosäädin mittaa tilan lämpötilaa ja välittää mittausravon 10 min välein kattoilmastointilaitteelle. Kattoilmastointilaitte sovitaa ohjearvoa tämän mittausravon mukaisesti.
Pehmeä käynnistys		<b>Ei FJX4233EEH:</b> Pehmeä käynnistys -toiminto pienentää kompressorin käynnistyksen aiheuttamaa virtapiikkiä. Jos virta otetaan generaattorista, generaattori ei ylikuormitu.

## 8 Ennen ensikäyttöä

### Tarkastukset ennen käyttöönottoa

Ennen kuin kytket kattoilmastointilaitteen päälle, huomaa seuraava:

1. Tarkista, vastaavatko syöttöjännitte ja taajuus kohdassa Tekniset tiedot sivulla 297 ilmoitettuja arvoja.
2. Varmista, että sekä ilman tuloaukko että ilmasuuttimet ovat esteettömiä. Kaikki tuuletusritilät täytyy aina pitää vapaina, jotta kattoilmastointilaitte voi toimia maksimitehollaan.

### Valmistele kaukosäädin (vain FreshJet FJX4233EEH/FJX4333E(EH)/FJX7333IHP/FJX7337IHP/FJX7457IHP)

3. Laita paristot paikoilleen (Kaukosäätimen paristojen vaihtaminen sivulla 290).

### Aseta aika (vain FreshJet FJX4233EEH/FJX4333E(EH)/FJX7333IHP/FJX7337IHP/FJX7457IHP)

4. Aseta nykyinen kellonaika (Nykyisen kellonajan asettaminen sivulla 287).

## 9 Käyttö

### 9.1 Vinkkejä käytön tehostamiseksi

Noudattamalla seuraavia vinkkejä voit parantaa kattoilmastointilaitteen suorituskykyä:

- Paranna ajoneuvosi lämpöeristystä tiivistämällä raot ja ripustamalla ikkunoihin heijastavat rullakaihtimet tai verhot.
- Valitse sopiva lämpötila ja puhallinteho.
- Suuntaa ilmasuuttimet järkevästi.
- Huolehdi siitä, että kangas, paperi tai muut esineet eivät peitä ilmasuuttimia ja ilman tuloaukkoja.

- **Vain FreshJet FJX4233EEH/FJX4333E(EH)/FJX7333IHP/FJX7337IHP/FJX7457IHP:** Jos ajoneuvo on alttiina suoralle auringonpaisteelle pitkän aikaa: Käytä kattoilmastointilaitetta Tuuletus-tilassa (🌀) ikkunat avattuina jonkin aikaa ennen kuin kytket Jäähdytys-tilan (❄️) päälle.
- **Vain FreshJet FJX4233EEH/FJX4333E(EH)/FJX7333IHP/FJX7337IHP/FJX7457IHP:** Vältä ovien ja ikkunoiden avaamista mahdollisuuksien mukaan, kun Jäähdytys-tila (❄️) on käytössä.

## 9.2 Perustietoa käytöstä

FreshJet FJX4233M -kattoilmastointilaitteessa on kolme toimintatilaa:

Toimintatila	Kuvaus
Pois	Kattoilmastointilaitte on kytketty pois päältä.
Jäähdytys	Kattoilmastointilaitte viilentää sisätilaa.
Tuuletus	Kattoilmastointilaitte kierrättää ilmaa, mutta ei viilennä.

FreshJet FJX4233EEH/FJX4333E(EH)/FJX7333IHP/FJX7337IHP/FJX7457IHP -kattoilmastointilaitteissa on kaksi toimintatilaa:

Toimintatila	Kuvaus
Valmiustila	Kattoilmastointilaitte on toimintavalmis, ja se voidaan kytkeä päälle kaukosäätimellä. Valaistus on käytettävissä. Kattoilmastointilaitte on jälleen valmiustilassa, mutta voit kytkeä kaukosäätimen päälle kattoilmastointilaitteesta riippumatta.
palaa	Kattoilmastointilaitte ilmastoi sisätilaa.

## 9.3 Dometic FJX4233M

Tämän luvun tiedot koskevat vain FJX4233M-kattoilmastointilaitteita.

### 9.3.1 Kattoilmastointilaitteen kytkeminen päälle ja pois päältä

Kattoilmastointilaitteessa on kaksi ilmastointitilaa:

- Tuuletus-tila (🌀)
- Jäähdytys-tila (❄️)



**Ohje** Odota vähintään 30 s, ennen kuin vaihdat Tuuletus-tilasta Jäähdytys-tilaan tai päinvastoin. Muussa tapauksessa kytkentävirta voi laukaista sulakkeeseen.

Kummassakin käyttötilassa on kolme tehoa:

- ..: Matala
- ...: Keskitaso
- ...: Korkea

- > Käyttötilat kytketään päälle kiertämällä kiertosäädin  asentoon Tuuletus () tai Jäähdytys () , minkä jälkeen valitaan haluttu teho.

✓ Kattoilmastointilaitteet kytkeytyy päälle ja toimii asetuksilla, jotka oli tehty ennen pois kytkemistä.

- > Käyttötilat kytketään pois päältä kiertämällä kiertosäädin  asentoon 0.

### 9.3.2 Lämpötilan säätö

- > Kierrä kiertosäädin  haluamaasi asentoon. Kiertämällä kiertosäädintä myötäpäivään säädät lämpötilaa viileämmäksi.

✓ Kattoilmastointilaitteen lämpötila on säädetty.

## 9.4 FreshJet FJX4233EEH/FJX4333E(EH)/FJX7333IHP/FJX7337IHP/FJX7457IHP

Tämän luvun tiedot koskevat vain FreshJet FJX4233EEH/FJX4333E(EH)/FJX7333IHP/FJX7337IHP/FJX7457IHP -kattoilmastointilaitteita.

### 9.4.1 Kaukosäätimen avulla



Huomaa seuraavat vinkit, kun käytät kaukosäädintä:

- Suuntaa kaukosäädin kohti ohjauspaneelin infrapunavastaanotinta.
- Asetukset ja arvot siirtyvät suoraan kattoilmastointilaitteeseen, kun painat jotakin painiketta.
- Kattoilmastointilaitteet vahvistaa tietojen vastaanoton äänimerkillä.
- Arvot suurenevät ja pienenevät nopeammin, jos pidät painikkeita + ja – painettuina pitkään.
- Valmiustilassa myös kaukosäätimen näyttö on pimeänä. Voit kytkeä kaukosäätimen päälle tai valmiustilaan kattoilmastointilaitteesta riippumatta.
- > Pelkkä kaukosäädin kytketään valmiustilaan tai siitä pois painamalla  -painiketta niin, että kaukosäätimellä ei osoiteta kohti ohjauspaneelin infrapunavastaanotinta.

### 9.4.2 Kattoilmastointilaitteen kytkeminen päälle ja valmiustilaan



**Ohje** Kun kattoilmastointilaitteet kytkeytyy päälle, se toimii asetuksilla, jotka oli tehty ennen valmiustilaan kytkemistä. Kattoilmastointilaitteita voidaan kytkeä pois päältä vain katkaisemalla virta.

- > Kytke kattoilmastointilaitteet päälle tai valmiustilaan painamalla kaukosäätimen  -painiketta tai ohjauspaneelin  -painiketta.



### 9.4.3 Ilmastointitilan valinta

- > Valitse haluamasi ilmastointitila MODE-painikkeella (Ilmastointitilat (vain FJX4233EEH/FJX4333E(EH)/FJX7333IHP/FJX7337IHP/FJX7457IHP) sivulla 283).
- ✓ Kattoilmastointilaitteet vahvistaa arvojen vastaanoton äänimerkillä. Kattoilmastointilaitteet kytketään valittuun ilmastointitilaan.

### 9.4.4 Tuuletintehon valitseminen manuaalisesti

Tuuletinteho voidaan valita manuaalisesti kaikissa muissa tiloissa paitsi Automaatti-tilassa (A) ja Kosteuden poisto-tilassa (U).

Näyttöilmoitus	Kuvaus
	Pieni tuuletinteho
	Keskinkertainen tuuletinteho
	Suuri tuuletinteho.
	Turbo-tuuletinteho.
	Automaatti-tila (tuuletinteho säätyy ympäristölämpötilan mukaan).

- > Valitse haluamasi tuuletinteho painamalla kaukosäätimen -painiketta tai ohjauspaneelin -painiketta.
- ✓ Kattoilmastointilaite vahvistaa arvojen vastaanoton äänimerkillä.

Uusi tuuletinteho on asetettu.

### 9.4.5 Lämpötilan säätö

Tiloissa Automaatti (A), Jäähdytys (❄️), Lämmitys (☀️) ja Kosteudenpoisto (U) voit määrittää lämpötilan alueella 16 °C – 31 °C.

- > Aseta haluamasi lämpötila kaukosäätimen painikkeilla + ja –.
- ✓ Kattoilmastointilaite vahvistaa arvojen vastaanoton korkealla äänellä. Kattoilmastointilaitteen lämpötila on säädetty.

### 9.4.6 Nykyisen kellonajan asettaminen

Kaukosäädin tarvitsee ajastinohjelmointia varten nykyisen kellonajan. Kellonaika näkyy kaukosäätimen näytössä.

1. Siirry Ajan asetus -tilaan painamalla -painiketta pitkään.
- ✓ Kellonaika vilkkuu kaukosäätimen näytössä.
2. Aseta aika painikkeilla + ja –. Ajan asettaminen nopeutuu, kun pidät painiketta + tai – painettuna pitempään kuin 2 s.
3. Vahvista kellonajan asetus painamalla painiketta SET.

### 9.4.7 Ajastimen ohjelmointi

Ajastintoiminnon avulla voit säätää ilmastoinnin halutulle aikavälille. Voit määrittää joko pelkän päällekytkemisajan tai pelkän poiskytkemisajan tai molemmat.

Ajastintoiminto asetetaan kaukosäätimellä.



**Ohje** Jos mitään kaukosäätimen painiketta ei paineta ajastimen ohjelmoinnin aikana 15 s kuluessa, kaukosäädin palaa alkuperäiseen tilaansa.

- > Aseta **päällekytkeytymisajastin** seuraavasti:
  - a) Valitse haluamasi ilmastointitila ja kaikki tarvittavat arvot (kuten lämpötila).
  - b) Jos kattoilmastointilaite ei ole valmiustilassa, kytke se valmiustilaan.  
Päällekytkeytymisajastimen voi asettaa vain, kun kattoilmastointilaite on **valmiustilassa**.
  - c) Paina painiketta  kerran.
  - ✓ Symboli  vilkkuu kaukosäätimen näytössä.
  - d) Aseta kellonaika, jona haluat kattoilmastointilaitteen kytkeytyvän päälle, painikkeilla + ja –.
  - e) Paina painiketta .

Päällekytkeytymisajastin on asetettu. Kattoilmastointilaite kytkeytyy päälle valitussa ilmastointitilassa ja asetettuna ajankohtana.
- > Aseta **valmiustilaan siirtymisen ajastin** seuraavasti:
  - a) Jos kattoilmastointilaite ei ole päällä, kytke se päälle.  
Valmiustilaan siirtymisen ajastin voidaan asettaa vain, jos kattoilmastointilaite on **päällä**.
  - b) Paina painiketta  kaksi kertaa.
  - ✓ Symboli  vilkkuu kaukosäätimen näytössä.
  - c) Aseta kellonaika, jona haluat kattoilmastointilaitteen siirtyvän valmiustilaan, painikkeilla + ja –.
  - d) Paina painiketta .

Valmiustilaan siirtymisen ajastin on asetettu. Kattoilmastointilaite kytkeytyy valmiustilaan ennalta säädettyinä ajankohtana.
- > Aseta **päällekytkeytymisajastin** ja **valmiustilaan siirtymisen ajastin** seuraavasti:
  - a) Valitse haluamasi ilmastointitila ja kaikki tarvittavat arvot (kuten lämpötila).
  - b) Paina painiketta  kolme kertaa.
  - ✓ Symboli  näkyy kaukosäätimen näytössä. Symboli ON vilkkuu.
  - c) Aseta kellonaika, jona haluat kattoilmastointilaitteen kytkeytyvän päälle, painikkeilla + ja –.
  - d) Paina painiketta .
  - ✓ Symboli **OFF** vilkkuu.
  - e) Aseta kellonaika, jona haluat kattoilmastointilaitteen siirtyvän valmiustilaan, painikkeilla + ja –.
  - f) Paina painiketta .

✓ Päällekytkeytymisajastin ja valmiustilaan siirtymisen ajastin on asetettu. Kattoilmastointilaite kytkeytyy päälle asetuksen mukaiseksi ajaksi.
- > Ajastinasetuksen voi **perua** painamalla -painiketta kerran.
- ✓ Symbolit   katoavat. Asetetut arvot hylätään.







## 9.4.8 Sleep-toiminnon asettaminen

Sleep-toiminto on käytettävissä vain tiloissa Jäähdytys (❄️) ja Lämmitys (🔥).

Sleep-toiminto rajoittaa tuulettimen tehon alemmalle tasolle melun vähentämiseksi ja nukkumisen helpottamiseksi.

**Vain FJX7333IHP/FJX7337IHP/FJX7457IHP:** Sleep-toiminto rajoittaa lisäksi kompressorin tehoa.



- > Aktivoi sleep-toiminto seuraavasti:
  - a) Aseta haluamasi lämpötila (Lämpötilan säätö sivulla 287).
  - b) Paina kaukosäätimen -painiketta tai ohjauspaneelin -painiketta.
- ✓ Kaukosäätimen näyttöön ilmestyy -symboli. Sleep-toiminto on aktivoitu.
  - > Deaktivoi sleep-toiminto painamalla kaukosäätimen painiketta  tai  taikka ohjauspaneelin painiketta .
- ✓ Symboli  katoaa kaukosäätimen näytöltä. Sleep-toiminto on deaktivoitu.

### 9.4.9 I feel -toiminnon aktivointi

Kun tämä toiminto on aktivoituna, kaukosäädin mittaa sisälämpötilaa ja välittää mittausarvon kattoilmastointilaitteelle 10 minuutin välein. Kattoilmastointilaitte sovitaa ohjearvoa tämän mittausarvon mukaisesti. I feel-toiminto on aktivoituna vain, kun lämpötila on +18 °C:n ja +29 °C:n välillä.

Kaukosäätimen ei tulisi olla tilan sellaisessa osassa, joka on oleellisesti lämpimämpi tai kylmempi kuin tila keskimäärin. Sitä ei esimerkiksi saa jättää auringonpaisteeseen tai kattoilmastointilaitteen eteen.

Jos lämpötila nousee yli +29 °C:een tai laskee +18 °C:n alapuolelle, I feel -toiminto kytkeytyy pois. Symboli  vilkkaa näytössä kolme kertaa ja sammuu sitten.

1. Paina painiketta.
- ✓ I feel-toiminto on aktivoitu.

Symboli  ilmestyy näyttöön.

2. Aseta kaukosäädin siten, että se osoittaa kohti ohjauspaneelin IR-vastaanotinta. Muuten arvoja ei voida lähettää kattoilmastointilaitteeseen.







### 9.4.10 Valaistuksen käyttö



**VAROITUS! Loukkaantumisvaara** Laki kieltää laitteen ulkovalojen käytön ajoneuvolla ajamisen aikana.

Kaukosäätimen -painike toimii, vaikka kaukosäädin olisikin kytketty pois päältä.

#### Vain FreshJet FJX4233EEH/FJX4333E(EH)/FJX7333IHP/FJX7337IHP/FJX7457IHP:

- > Sisätilan valot kytketään päälle ja pois painamalla kaukosäätimen tai ohjauspaneelin -painiketta.
- ✓ Symboli  vilkkaa kaukosäätimen näytössä kerran, kun sisävalot kytketään **päälle**.
  - > Sisävaloja himmennetään seuraavasti:
    - a) Paina kaukosäätimen tai ohjauspaneelin -painiketta 3 s ajan.
    - b) Jos painat kaukosäätimen -painiketta: Painamalla -painiketta sisävaloja himmennetään alueella 50 % – 100 %.
    - c) Jos painat ohjauspaneelin -painiketta: Sisävalojen kirkkaus kiertää alueella 50 % – 100 %. Päästä -painike, kun kirkkaus on haluamallasi tasolla.

#### Vain FreshJet FJX7333IHP/FJX7337IHP/FJX7457IHP:

- > Ulkovalot kytketään päälle ja pois painamalla ohjauspaneelin -painiketta.

## 9.4.11 Kaukosäätimen paristojen vaihtaminen



**Ohje** Kaukosäätimen näyttö voi olla vielä kirkas, vaikka paristojen teho on vähissä. Vaihda paristot, kun kaukosäädin ilmaisee paristojen tehon olevan vähissä.

- > Vaihda paristot kuvan osoittamalla tavalla.

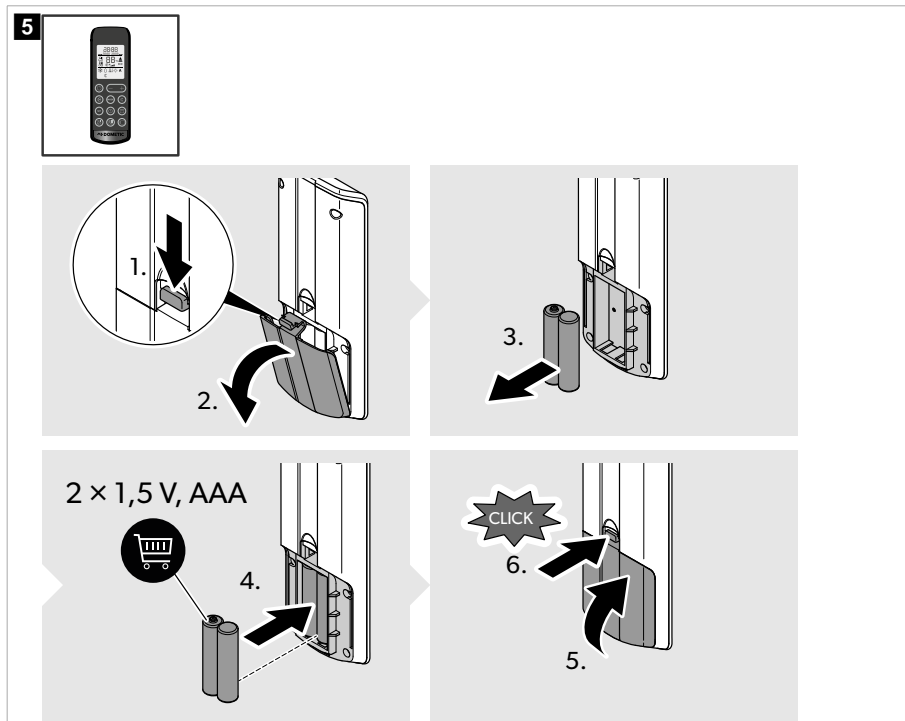

- ✓ Kaikki symbolit näkyvät näytössä 5 s ajan.



Muista ympäristönsuojelu! Akut ja paristot eivät kuulu kotitalousjätteen sekaan. Toimita vialliset akut tai käytetyt paristot kauppiaille tai keräyspisteeseen.

## 9.5 Ilmavirtauksen säätö ajoneuvossa

Ilmavirtaus voidaan säätää sisäkattoon tai lattiaan päin.

- > Käännä kunkin ilmasuuttimen säleet haluamaasi suuntaan.

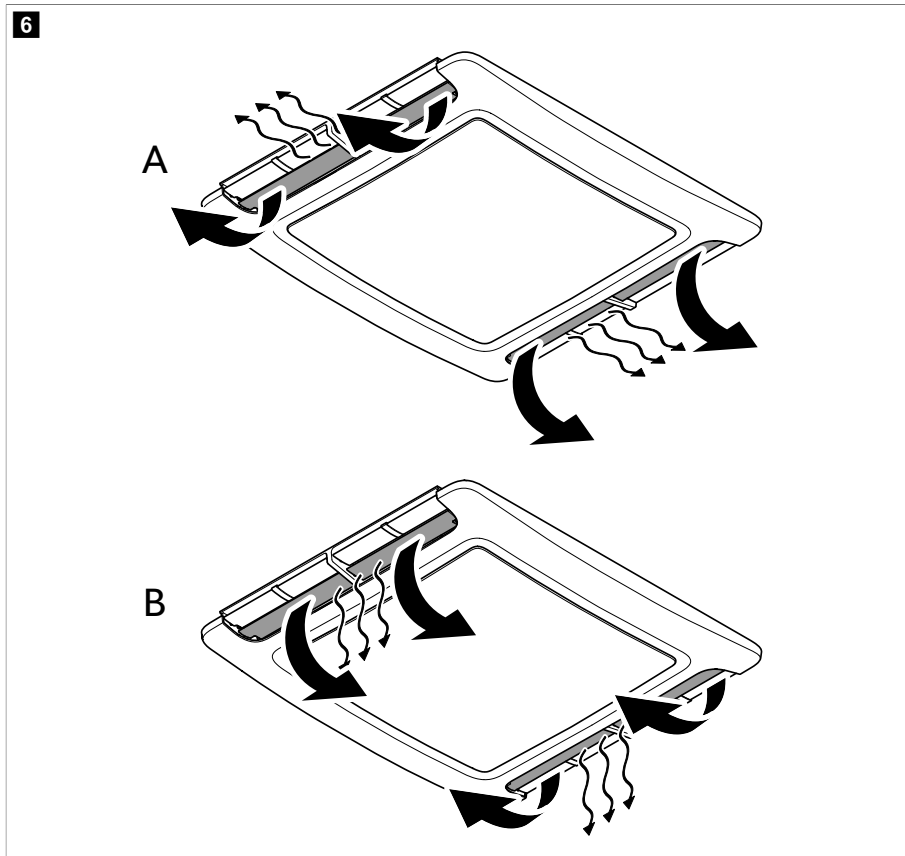

## 10 Kattoilmastointilaitteen puhdistus



### HUOMAUTUS! Vahingonvaara

- Älä käytä sulattamisen nopeuttamiseen tai puhdistamiseen muita kuin valmistajan suosittelemia keinoja.
- Älä puhdista kattoilmastointilaitetta korkeapainepesurilla. Sisään tunkeutuva vesi voi vahingoittaa kattoilmastointilaitetta.
- Puhdistukseen ei saa käyttää teräviä tai kovia välineitä tai voimakkaita puhdistusaineita, koska tämä voi johtaa kattoilmastointilaitteen vahingoittumiseen.
- Älä käytä bensiiniä, dieseliä tai liuottimia.

1. Poista lehdet ja muut roskat ja lika kattoilmastointilaitteen ilman tuloaukosta ja tuuletusritilöistä säännöllisesti. Varo tätä tehdessäsi vaurioittamasta tuuletusritilöitä.

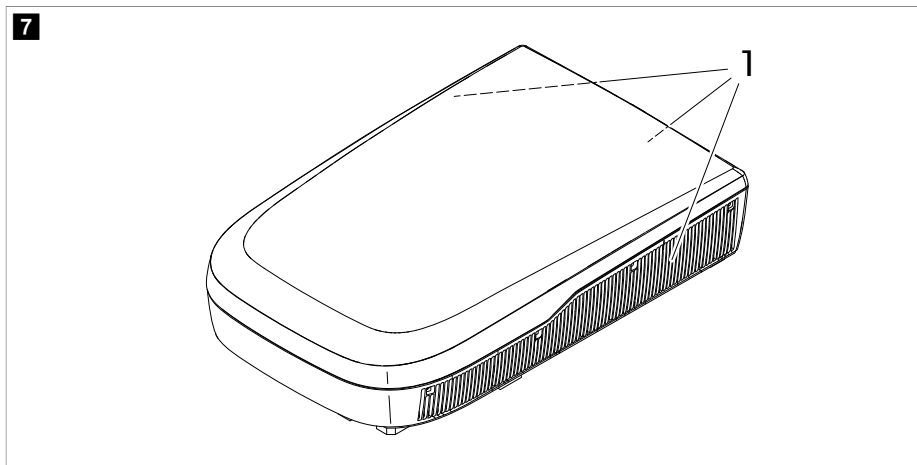

2. Puhdista kattoyksikön ja ilmanjakolaatikon kotelo ajoittain kostealla liinalla. Käytä vain vettä ja mietoja puhdistusaineita.
3. **Vain FreshJet FJX4233EEH/FJX4333E(EH)/FJX7333IHP/FJX7337IHP/FJX7457IHP:** Puhdista kaukosäädin ajoittain hieman kostutetulla liinalla. Puhdista näyttö silmälasiinpuhdistusliinalla.
4. **Vain FreshJet FJX4233EEH/FJX4333E(EH)/FJX7333IHP/FJX7337IHP/FJX7457IHP** Puhdista ilmanjakolaatikon näyttö ajoittain miedolla, lämpimällä saippuavesiliuoksella. Näyttörautu on akryylia ja voi vaurioitua tietyistä tavallisista kotitalouskemikaaleista kuten kemiallisista puhdistusaineista, ikkunanpesuaineista, alkoholista, tietyistä tensideistä, orgaanisista liuottimista ja pehmittäjäaineista.

## 11 Huolto



**VAROITUS! Loukkaantumisvaara** Muita kuin tässä kuvattuina huoltotoimia saavat suorittaa vain pätevät ammattilaiset, jotka tuntevat kylmäaineiden ja ilmastointilaitteiden käsittelyyn liittyvät vaarat sekä oleelliset määräykset.

## Väli

## Tarkastus/huolto

Säännöllisesti

Tarkasta, ovatko kattoilmastointilaitteen sivuilla olevat kondenssiveden poistokanavat (1) puhtaat ja pääseekö kondenssivesi valumaan pois.

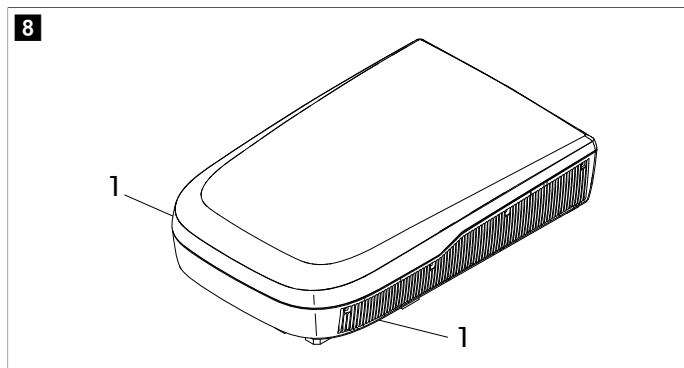

Säännöllisesti (Freshjet FJX4233M)

Puhdista poistoyksikön ilmansuodatin.

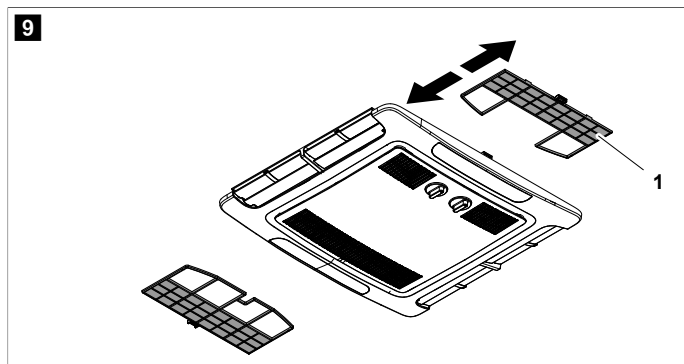

1. Ota suodatin pois (1).
2. Puhdista suodatin (1) puhdistusaineliuksella ja anna kuivua.
3. Aseta kuiva suodatin (1) takaisin paikalleen.

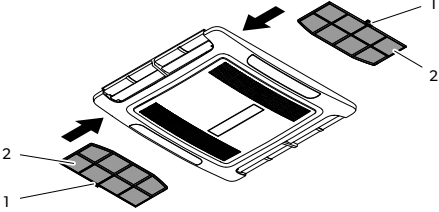
Väli	Tarkastus/huolto
Säännöllisesti (Fresh-Jet FJX4233EEH/ FJX4333E(EH)/FJX7333IHP/ FJX7337IHP/FJX7457IHP)	<ul style="list-style-type: none"> <li>Puhdista poistoyskikön ilmansuodatin.</li> </ul> <div data-bbox="368 228 1019 528" style="border: 1px solid black; padding: 10px;"> <p><b>10</b></p>  </div> <ol style="list-style-type: none"> <li>Työnnä kahvaan (1) talttapääruuvimeisseli tai veitsi, jotta saat vedettyä suodattimia (2) hieman ulos.</li> <li>Poista suodattimet käsin.</li> <li>Puhdista suodattimet puhdistusaineliuksella ja anna kuivua.</li> <li>Liu'uta kuivat suodattimet takaisin paikoilleen. kuva. 10 sivulla 294</li> </ol> <ul style="list-style-type: none"> <li>Teetä kattoilmastointilaitteen lämmönvaihtimen huolto alan yrityksessä.</li> </ul>
Kerran vuodessa	<ul style="list-style-type: none"> <li>Tarkasta kattoilmastointilaitteen ja ajoneuvon katon väliset tiivisteet murtumien ja muiden vaurioiden varalta.</li> <li>Tarkasta, että kiinnityspultit on kiristetty oikealla momentilla (2.5 Nm ± 0.3 Nm) ja säädä tarvittaessa.</li> </ul>

## 12 Vianetsintä

Häiriö	Mahdollinen syy	Ratkaisuehdotus
Jäähdytys ei toimi hyvin	Kattoilmastointilaitetta ei ole asetettu jäähdytykselle.	Aseta kattoilmastointilaitte jähdytykselle.
	Ympäristölämpötila on yli 52 °C.	Kattoilmastointilaitte on suunniteltu käytettäväksi maks.-ympäristölämpötilassa 52 °C.
	Säädetty lämpötila on korkeampi kuin sisätilan lämpötila.	Valitse matalampi lämpötila.
	Ympäristölämpötila on alle 16 °C.	Kattoilmastointilaitte on suunniteltu jäähdyttämään vain, kun ympäristön lämpötila on yli 16 °C.
	Jokin lämpötila-anturi on rikki.	Ota yhteyttä valtuutettuun huoltopalveluun tai Dometiciin.
	Höyrystintuuletin on vioittunut.	Ota yhteyttä valtuutettuun huoltopalveluun tai Dometiciin.

Häiriö	Mahdollinen syy	Ratkaisuehdotus
	Lauhdutinpuhallin on vioittunut.	Ota yhteyttä valtuutettuun huoltopalveluun tai Dometiciin.
<b>Vain FreshJet FJX4233EEH/ FJX4333E(EH)/FJX7333IHP/ FJX7337IHP/FJX7457IHP:</b> Lämmitys ei toimi hyvin	Kattoilmastointilaitetta ei ole asetettu lämmitykselle.	Aseta kattoilmastointilaitte lämmitykselle.
	Ympäristölämpötila on alle $-2^{\circ}\text{C}$ .	Kattoilmastointilaitte on suunniteltu käytettäväksi ympäristölämpötilassa, joka on yli $-2^{\circ}\text{C}$ .
	Säädetty lämpötila on matalampi kuin sisätilan lämpötila.	Valitse korkeampi lämpötila.
	Jokin lämpötila-anturi on rikki.	Ota yhteyttä valtuutettuun huoltopalveluun tai Dometiciin.
	Höyrystintuuletin on vioittunut.	Ota yhteyttä valtuutettuun huoltopalveluun tai Dometiciin.
Vähäinen ilmantuotto	Ilman tuloaukot ovat tukossa tai peittyneet.	Poista kaikki lehdet ja muu liika kattoilmastointilaitteen tuuletusritilöistä.
	Puhallin on rikki.	Ota yhteyttä valtuutettuun huoltopalveluun tai Dometiciin.
Ajoneuvoon tulee vettä.	Kondenssiveden valuma-aukot ovat tukossa.	Puhdista kondenssiveden valuma-aukot.
	Tiivisteet ovat rikki.	Ota yhteyttä valtuutettuun huoltopalveluun tai Dometiciin.
Kattoilmastointilaitte ei kytkeydy päälle.	Virtajohtoa ei ole liitetty.	Tarkasta virransyöttö.
	Jännite on liian alhainen ( $< 200\text{ V}$ ).	Ota yhteyttä valtuutettuun huoltopalveluun tai Dometiciin.
	Jännitteenmuunnin on rikki.	Ota yhteyttä valtuutettuun huoltopalveluun tai Dometiciin.
	Jokin lämpötila-anturi on rikki.	Ota yhteyttä valtuutettuun huoltopalveluun tai Dometiciin.
	Virransyötön sähkösulake on liian pieni.	Ota yhteyttä valtuutettuun huoltopalveluun tai Dometiciin.
Kattoilmastointilaitte ei kytkeydy pois päältä.	Jokin lämpötila-anturi on rikki.	Ota yhteyttä valtuutettuun huoltopalveluun tai Dometiciin.
	Virransyötön sähkösulake on liian pieni.	Ota yhteyttä valtuutettuun huoltopalveluun tai Dometiciin.
<b>Vain FreshJet FJX4233EEH/ FJX4333E(EH)/FJX7333IHP/ FJX7337IHP/FJX7457IHP:</b> Kattoilmastointilaitte kytkeytyy jatkuvasti pois päältä.	Jäätymisanturi on liiapaissut.	Ulkolämpötila on liian alhainen tai kaikki ilmasuuttimet ovat kiinni.

Häiriö	Mahdollinen syy	Ratkaisuehdotus
Näytössä näky: P0	IPM-moduulin ylikuumentuminen tai ylivirta	Ota yhteyttä valtuutettuun huoltopalveluun tai Dometiciin.
Näytössä näky: P1	Alijännitesuojaus	Ota yhteyttä valtuutettuun huoltopalveluun tai Dometiciin.
Näytössä näky: P2	Vaihtovirtayksikön ylivirtasuoja	Ota yhteyttä valtuutettuun huoltopalveluun tai Dometiciin.
Näytössä näky: P4	Poistoputken ylikuumentumissuoja	Ota yhteyttä valtuutettuun huoltopalveluun tai Dometiciin.
Näytössä näky: P5	Höyrystimen käämisuoja (jäähdytystila)	Ota yhteyttä valtuutettuun huoltopalveluun tai Dometiciin.
Näytössä näky: P6	Lauhduttimen käämisuoja (jäähdytystila)	Ota yhteyttä valtuutettuun huoltopalveluun tai Dometiciin.
Näytössä näky: P7	Höyrystimen käämisuoja (lämmitystila)	Ota yhteyttä valtuutettuun huoltopalveluun tai Dometiciin.
Näytössä näky: P9	Kompressorin käyttöyksikkö poikkeaa normaalista tai kompressori ei käynnisty	Ota yhteyttä valtuutettuun huoltopalveluun tai Dometiciin.
Näytössä näky: E0	Kommunikaatiovirhe	Ota yhteyttä valtuutettuun huoltopalveluun tai Dometiciin.
Näytössä näky: E1	Sisälämpötila-anturin virhe	Ota yhteyttä valtuutettuun huoltopalveluun tai Dometiciin.
Näytössä näky: E2	Höyrystimen käämin lämpötila-anturin virhe	Ota yhteyttä valtuutettuun huoltopalveluun tai Dometiciin.
Näytössä näky: E3	Lauhduttimen käämin lämpötila-anturin virhe	Ota yhteyttä valtuutettuun huoltopalveluun tai Dometiciin.
Näytössä näky: E7	Ulkolämpötila-anturin vika	Ota yhteyttä valtuutettuun huoltopalveluun tai Dometiciin.
Näytössä näky: E8	Poistoputken lämpötila-anturin vika	Ota yhteyttä valtuutettuun huoltopalveluun tai Dometiciin.
Näytössä näky: E9	Kompressorin käyttöyksikön tai IPM-moduulin virhe	Ota yhteyttä valtuutettuun huoltopalveluun tai Dometiciin.
Näytössä näky: EA	Virta-anturin virhe	Ota yhteyttä valtuutettuun huoltopalveluun tai Dometiciin.
Näytössä näky: EE	Ulko-EEPROMin virhe	Ota yhteyttä valtuutettuun huoltopalveluun tai Dometiciin.
Näytössä näky: EL	LIN-väylän/CI-väylän kommunikaatiovirhe	Ota yhteyttä valtuutettuun huoltopalveluun tai Dometiciin.



## 13 Hävittäminen



Vie pakkausmateriaali mahdollisuuksien mukaan niille tarkoitettuihin kierrätysjäteastioihin. Tiedustele lähimmästä kierrätyskeskuksesta tai erikoisliikkeestä tuotetta koskevia yksityiskohtaisia hävittämistä koskevia ohjeita.



Muista ympäristönsuojelua! Akut ja paristot eivät kuulu kotitalousjätteen sekaan. Toimita vialliset akut tai käytetyt paristot kauppiaille tai keräyspisteeseen.

## 14 Takuu

Tuotetta koskee lakisääteinen tuotevastuu-aika. Jos tuote on viallinen, ota yhteyttä valmistajan toimipisteeseen omissa maassasi (ks. [dometic.com/dealer](http://dometic.com/dealer)) tai jälleenmyyjään.

Jos lähetät tuotteen korjattavaksi, liitä korjaus- ja takuukäsittelyä varten mukaan seuraavat asiakirjat:

- Kopio kuitista, jossa näkyy ostopäivä
- Valitusperuste tai vikakuvaus

Huomaa, että itse tai väärin tehty korjaus voi vaarantaa turvallisuuden ja johtaa takuun raukeamiseen.

## 15 Tekniset tiedot

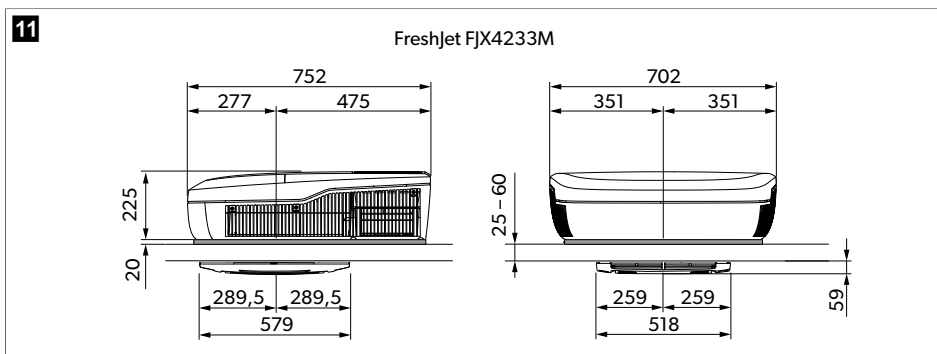

12

FJX4233EEH, FJX4333E(EH), FJX7333IHP

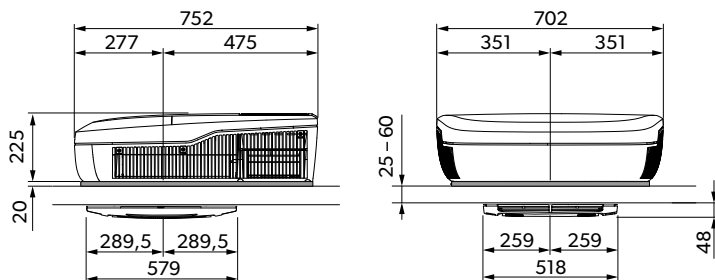

13

FreshJet FJX7337IHP

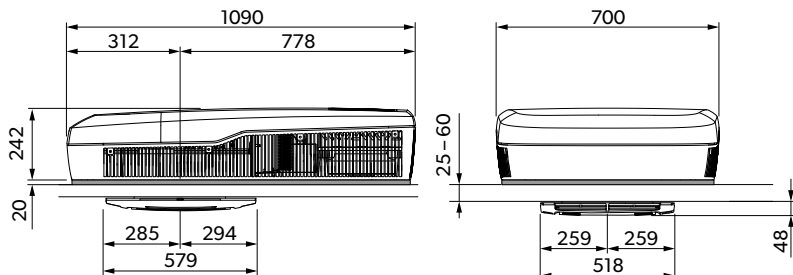

14

FreshJet FJX7457IHP

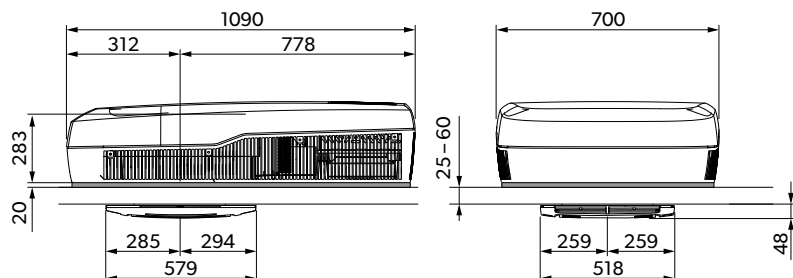

Sisältää fluorattuja kasvihuonekaasuja. Hermeettisesti suljettu laite.

	<b>FreshJet FJX4233M</b>
Jäähdytysteho ISO-5151:n mukaan:	1500 W
Vaihtovirtajännite:	220 V ... 240 V / 50 Hz

	<b>FreshJet FJX4233M</b>
Nimellisvirta, jäädytys:	< 3.3 A
Tarvittava sulake:	4 A
Käyttölämpötila-alue:	- 2 °C ... 52 °C
Kylmäaine:	R410a
Kylmäaineen määrä:	380 g
CO <sub>2</sub> -ekvivalentti:	0.793 t
Vaikutus ilmaston lämpenemiseen (GWP):	2088
Kotelointiluokka (kattoyksikkö):	IPX4
Melutaso (suurimmalla tuuletusteholla)	< 70 dB(A)
Suosittelun maks. ajoneuvopituus (ml. eristetyt seinät):	< 5 m
Mitat P x L x K:	kuva. <b>11</b> sivulla 297
Paino:	< 30 kg
Tarkastus/sertifikaatti:	

	<b>FreshJet FJX4233EEH</b>	<b>FreshJet FJX4333EEH</b>	<b>FreshJet FJX4333E</b>
Jäädytysteho ISO-5151:n mukaan:	1700 W	2200 W	2200 W
Lämmitysteho ISO 5151:n mukaan:	800 W	1000 W	-
Vaihtovirtajännite:	220 V ... 240 V / 50 Hz		
Nimellisvirta, jäädytys:	3.6 A	4.8 A	4.8 A
Nimellisvirta, lämmitys:	< 5.2 A	< 5.2 A	-
Tarvittava sulake:	4 A	5 A	6 A
Käyttölämpötila-alue:	- 2 °C ... 52 °C		
Kylmäaine:	R32		
Kylmäaineen määrä:	320 g	360 g	360 g

	<b>FreshJet FJX4233EEH</b>	<b>FreshJet FJX4333EEH</b>	<b>FreshJet FJX4333E</b>
CO <sub>2</sub> -ekvivalentti:	0.216 t	0.243 t	0.243 t
Vaikutus ilmaston lämpenemiseen (GWP):	675		
Kotelointiluokka (kattoyksikkö):	IPX4		
Melutaso (suurimmalla tuulesteholla)	< 70 dB(A)		
Suositeltu maks. ajoneuvopituus (ml. eristetyt seinät):	< 6 m	< 7 m	< 7 m
Mitat P x L x K:	kuva. <b>12</b> sivulla 298		
Paino:	< 30 kg	< 30 kg	< 30 kg
Tarkastus/sertifikaatti:			

	<b>FreshJet FJX7333IHP</b>	<b>FreshJet FJX7337IHP</b>	<b>FreshJet FJX7457IHP</b>
Jäähdytysteho ISO-5151:n mukaan:	2200 W	3000 W	3500 W
Lämmitysteho ISO 5151:n mukaan:	2000 W	2500 W	3000 W
Vaihtovirtajännite:	220 V ... 240 V / 50 Hz ... 60 Hz	220 V ... 240 V / 50 Hz ... 60 Hz	220 V ... 240 V / 50 Hz ... 60 Hz
Nimellisvirta, jäähdytys:	< 7.5 A	< 7.5 A	< 7.5 A
Nimellisvirta, lämmitys:	< 6.1 A	< 6.1 A	< 6.1 A
Tarvittava sulake:	6 A	6 A	6 A
Käyttölämpötila-alue:	- 2 °C ... 52 °C	- 2 °C ... 52 °C	- 2 °C ... 52 °C
Kylmäaine:	R32	R32	R32
Kylmäaineen määrä:	420 g	480 g	650 g
CO <sub>2</sub> -ekvivalentti:	0.2835 t	0.3240 t	0.43875 t
Vaikutus ilmaston lämpenemiseen (GWP):	675		
Kotelointiluokka (kattoyksikkö):	IPX4		
Melutaso (suurimmalla tuulesteholla)	< 70 dB(A)		

	<b>FreshJet FJX7333IHP</b>	<b>FreshJet FJX7337IHP</b>	<b>FreshJet FJX7457IHP</b>
Suositteltu maks. ajoneuvopituus (ml. eristetyt seinät):	< 7 m	< 7 m	> 8 m
Mitat P x L x K:	kuva. <b>12</b> sivulla 298	kuva. <b>13</b> sivulla 298	kuva. <b>14</b> sivulla 298
Paino:	< 30 kg	< 35 kg	< 40 kg
Tarkastus/sertifikaatti:			

## Russian

1	Important notes.....	302
2	Пояснение к символам.....	302
3	Указания по технике безопасности.....	304
4	Использование по назначению.....	305
5	Пояснения к символам на устройстве.....	306
6	Технические пределы и условия.....	306
7	Техническое описание.....	306
8	Перед первым использованием.....	313
9	Эксплуатация.....	313
10	Очистка накрывного кондиционера.....	321
11	Уход и обслуживание.....	322
12	Устранение неисправностей.....	323
13	Утилизация.....	326
14	Гарантия.....	326
15	Технические характеристики.....	327

## 1 Important notes

Пожалуйста, внимательно прочтите и соблюдайте все указания, рекомендации и предупреждения, содержащиеся в этом руководстве по использованию изделия, чтобы гарантировать правильную установку, использование и обслуживание изделия. Эта инструкция ДОПЖНА оставаться вместе с этим изделием.

Используя изделие, вы тем самым подтверждаете, что внимательно прочитали все указания, рекомендации и предупреждения, а также, что вы понимаете и соглашаетесь соблюдать положения и условия, изложенные в настоящем документе. Вы соглашаетесь использовать это изделие только по прямому назначению и в соответствии с указаниями, рекомендациями и предупреждениями, изложенными в данном руководстве по использованию изделия, а также в соответствии со всеми применимыми законами и правилами. Несоблюдение указаний и предупреждений, изложенных в данном документе может привести к травмам вас и других лиц, повреждению вашего изделия или повреждению другого имущества, находящегося поблизости. Данное руководство по использованию изделия, включая указания, рекомендации и предупреждения, а также сопутствующую документацию, может подвергаться изменениям и обновлениям. Актуальную информацию о продукте можно найти на сайте [documents.dometic.com](http://documents.dometic.com).

## 2 Пояснение к символам



**ОПАСНОСТЬ!** Указывает на опасную ситуацию, которая, если ее не избежать, приведет к смерти или серьезным травмам.



**ПРЕДУПРЕЖДЕНИЕ!** Указывает на опасную ситуацию, которая, если ее не избежать, приведет к смерти или серьезным травмам.



**ОСТОРОЖНО!** Указывает на опасную ситуацию, которая, если ее не избежать, может привести к травмам легкой или средней степени тяжести.



**ВНИМАНИЕ!** Указывает на опасную ситуацию, которая, если ее не избежать, может привести к травмам легкой или средней степени тяжести.



**Указание** Дополнительная информация по управлению продуктом.

### 3 Указания по технике безопасности



**ПРЕДУПРЕЖДЕНИЕ! Несоблюдение этих предупреждений может привести к смерти или серьезной травме.**

- **Электроприборы не являются детскими игрушками.** Изделие не должно использоваться лицами (включая детей) с ограниченными физическими, сенсорными или умственными возможностями или недостатком опыта и знаний, если они не находятся под наблюдением или не получили указаний.
- Необходимо постоянно следить за детьми и не допускать игр с изделием.
- Это изделие может использоваться детьми с 8-ми лет и старше, а также лицами с ограниченными физическими, сенсорными и умственными возможностями или при недостатке необходимого опыта и знаний только под присмотром или после прохождения инструктажа по безопасному использованию изделия, если они понимают опасности, которые при этом могут возникнуть.
- Запрещается выполнять очистку детям без присмотра.
- Любое лицо, участвующее в работе или вскрытии холодильного контура, должно иметь действующий сертификат от аккредитованного в отрасли органа проверки знаний, который подтверждает их компетентность в области безопасного обращения с хладагентами в соответствии с признанными в отрасли техническими условиями оценки.
- Техническое обслуживание должно выполняться только в соответствии с рекомендациями изготовителя оборудования. Техническое обслуживание и ремонт, требующие помощи другого квалифицированного персонала, должны выполняться под наблюдением лица, компетентного в области использовании легковоспламеняющихся хладагентов.
- Ремонт устройства разрешается выполнять только специалистам, знакомым с возможными опасностями и с соответствующими стандартами и предписаниями. Если ремонт выполнен неправильно, эксплуатация устройства может представлять опасность. При необходимости ремонта обратитесь в сервисный центр в вашей стране (см. [dometic.com/dealer](http://dometic.com/dealer)).
- Перед выполнением работ на устройстве всегда отсоединяйте устройство от источника питания.
- Устройство должно храниться в помещении без постоянно работающих источников возгорания открытой открытого огня, например, работающего газового прибора или работающего электрического обогревателя.
- Не прокалывайте и не сжигайте устройство.
- Помните, что хладагенты не могут иметь запах.
- Не эксплуатируйте устройство вблизи легковоспламеняющихся жидкостей или в закрытых помещениях.
- Следите за тем, чтобы горючие предметы не складировались и не устанавливались в зоне выхода воздуха. Расстояние должно составлять не менее 50 см.
- Следите за тем, чтобы вентиляционные отверстия не были засорены.
- Не допускайте повреждений холодильного контура.
- Ни при каких обстоятельствах потенциальные источники воспламенения не должны использоваться при поиске или обнаружении утечек хладагента. Запрещается использовать галоидный течееискатель (или любой другой детектор, использующий открытое пламя).
- Накрышный кондиционер должен устанавливаться в транспортном средстве с площадью пола, превышающей 4 м<sup>2</sup>.



**ОСТОРОЖНО! Несоблюдение этих предостережений может привести к травме легкой или средней степени тяжести.**

- Не вводить руки в выходные вентиляционные отверстия и не вводить инородные предметы в устройство.
- В случае пожара не снимайте верхнюю крышку устройства. Используйте допущенные средства пожаротушения. Не используйте воду для тушения пожара.
- Чтобы не допустить возникновения опасных ситуаций, замена поврежденного кабеля питания должна производиться изготовителем, сервисным центром или имеющим аналогичную квалификацию персоналом.
- В случае, если устройство содержит ионизатор, проконсультируйтесь со своим врачом, если у вас есть какие-либо заболевания. Ионизатор может генерировать озон (ОЗ) в небольших количествах. Если вы страдаете заболеваниями легких, астмой, заболеваниями сердца, респираторными заболеваниями, проблемами с дыханием или чувствительны к озону, проконсультируйтесь со своим врачом, чтобы определить, безопасно ли для вас использование этого устройства.

**ВНИМАНИЕ! Риск повреждения**

- Не используйте средства для ускорения процесса размораживания или очистки, кроме тех, которые рекомендованы изготовителем.
- Устройство должно храниться таким образом, чтобы предотвратить возникновение механических повреждений.
- Не выполняйте никаких изменений и переделок на приборе.
- При установленном устройстве запрещается въезд в автоматическую автомобильную мойку.
- Чтобы не допустить возникновения опасных ситуаций, при возникновении неисправностей в холодильном контуре устройство должно быть проверено и отремонтировано изготовителем, сервисным центром или имеющим аналогичную квалификацию персоналом.

## 4 Использование по назначению

Накрышный кондиционер FreshJet FJX предназначен только для установки на крыше автофургона или жилого прицепа в целях обеспечения охлаждения.

Накрышный кондиционер **не** предназначен для поездов, домов и квартир. Накрышный кондиционер **не** пригоден для монтажа на строительных и сельскохозяйственных машинах или аналогичном рабочем оборудовании.

Это изделие подходит только для использования по назначению и применения в соответствии с данной инструкцией.

В данной инструкции содержится информация, необходимая для правильного монтажа и/или эксплуатации изделия. Неправильный монтаж и/или ненадлежащая эксплуатация или техническое обслуживание приводят к неудовлетворительной работе и возможному отказу.

Изготовитель не несет ответственности за какие-либо травмы или повреждение продукта в результате следующих причин:

- Неправильная сборка или подключение, включая повышенное напряжение
- Неправильное техническое обслуживание или использование запасных частей, отличных от оригинальных запасных частей, предоставленных изготовителем
- Изменения в продукте, выполненные без однозначного разрешения изготовителя

- Использование в цепях, отличных от указанных в данной инструкции

Компания Dometic оставляет за собой право изменять внешний вид и технические характеристики продукта.

## 5 Пояснения к символам на устройстве



Предупреждение! Материал с низкой скоростью горения.



Прочтите инструкцию по эксплуатации.



Прочтите инструкции по техническому обслуживанию.

## 6 Технические пределы и условия

Накрышный кондиционер предназначен для транспортных средств с крышами толщиной 25 м ... 60 м.

Накрышный кондиционер эффективно функционирует при температурах окружающего воздуха между  $-2^{\circ}\text{C}$  ...  $52^{\circ}\text{C}$ . Накрышный кондиционер предназначен для установки в пределах  $\pm 10^{\circ}$  от горизонтальной плоскости. Производительность накрышного кондиционера может снизиться, если он подвергается сильным вибрациям, например, вызванным плохими дорожными условиями.

## 7 Техническое описание

Накрышный кондиционер FreshJet FJX4233M снабжает салон автомобиля холодным воздухом, который не содержит пыли и грязи и может быть осушен.

Накрышный кондиционер FreshJet FJX4233EEN/FJX4333E(EH)/FJX7333IHP/FJX7337IHP/FJX7457IHP снабжает салон автомобиля холодным или теплым воздухом, который не содержит пыли и грязи и может быть осушен.

Кондиционер в состоянии опустить температуру во внутреннем помещении автомобиля до определенного значения, которое зависит от типа транспортного средства, температуры окружающей среды и холодопроизводительности кондиционера. При температуре ниже  $16^{\circ}\text{C}$  накрышный кондиционер больше не охлаждает.

Кондиционер управляется следующими элементами управления:

- Панель управления

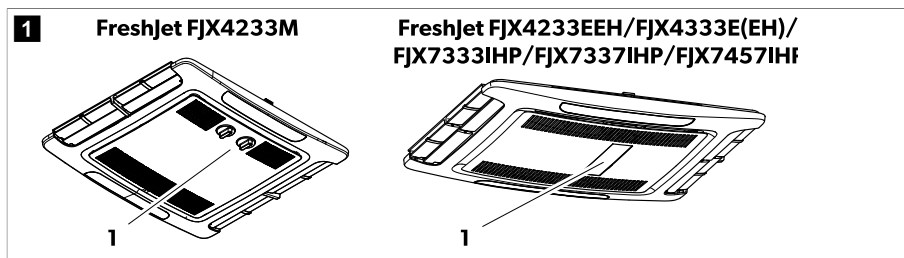

- Пульт дистанционного управления (только FJX4233EEH/FJX4333E(EH)/FJX7333IHP/FJX7337IHP/FJX7457IHP)

## 7.1 Список моделей

В следующей таблице показано, какая функция применяется к конкретной модели:





● функция доступна

○ имеется возможность дооснащения функцией

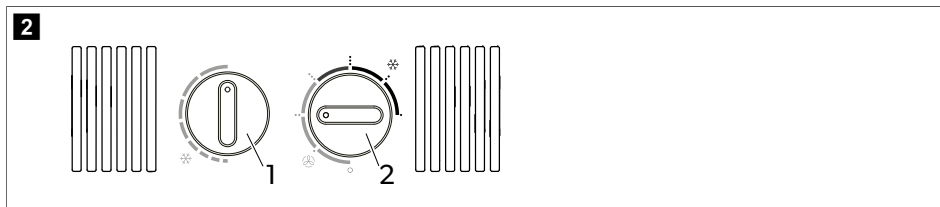
	FJX4233M	FJX4233EEH	FJX4333EEH	FJX4333E	FJX7333IHP	FJX7337IHP	FJX7457IHP
Автоматический		●	●	●	●	●	●
Охлаждение	●	●	●	●	●	●	●
Нагрев		●	●	○	●	●	●
Вентиляция	●	●	●	●	●	●	●
Удаление влаги из воздуха		●	●	●	●	●	●
Воздухоочиститель	○	●	●	○	●	●	●
Лампа ADB		●	●	○	●	●	●
Внешнее освещение					●	●	●
Таймер		●	●	●	●	●	●
Сон		●	●	●	●	●	●
Soft Start			●	○	●	●	●







## 7.2 Панель управления FreshJet FJX4233M

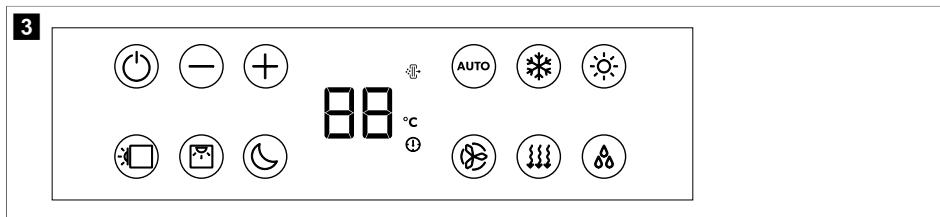











Ручка	Наименование
	Выбирает температуру. Поверните по часовой стрелке для более сильного охлаждения.
	Включает или выключает кондиционер на крыше и выбирает интенсивность циркуляции воздуха в режиме вентиляции (  ) или интенсивность охлаждения в режиме охлаждения (  )

## 7.3 Панель управления FreshJet FJX4233EEN/FJX4333E(EN)/FJX7333IHP/FJX7337IHP/FJX7457IHP



Символ	Наименование
	Включает кондиционер или переключает его в режим ожидания.
	Увеличивает текущее отображаемое значение.
	Уменьшает текущее отображаемое значение.
	Сопряжение с Bluetooth/Wi-Fi при одновременном нажатии обеих кнопок.
	Включает или выключает окружающее освещение в кондиционере.
	Включает или выключает окружающее освещение в воздухораспределителе.
	Активирует функцию «сон» (Дополнительные функции (только FJX4233EEN/FJX4333E(EN)/FJX7333IHP/FJX7337IHP/FJX7457IHP) стр. 312).

Символ	Наименование
	Отображает настроенную температуру и указывает уровень мощности вентилятора при настройке вентилятора.
	Указывает на активный режим очистки воздуха AirPurifier.
	Указывает, что температура отображается в градусах Цельсия.
	Указывает, что таймер настроен.
	Активирует/деактивирует автоматический режим (Режимы кондиционирования воздуха (только FJX4233EEN/FJX4333E(EN)/FJX7333IHP/FJX7337IHP/FJX7457IHP) стр. 312).
	Активирует/деактивирует режим охлаждения (Режимы кондиционирования воздуха (только FJX4233EEN/FJX4333E(EN)/FJX7333IHP/FJX7337IHP/FJX7457IHP) стр. 312).
	Активирует/деактивирует режим нагрева (Режимы кондиционирования воздуха (только FJX4233EEN/FJX4333E(EN)/FJX7333IHP/FJX7337IHP/FJX7457IHP) стр. 312).
	Регулирует скорость вентилятора между положениями Low, Med, High, Turbo или Auto (отображается при изменении как 1, 2, 3, 4 или AA на дисплее воздухораспределителя в течение короткого времени).
	Активирует/деактивирует режим вентиляции (Режимы кондиционирования воздуха (только FJX4233EEN/FJX4333E(EN)/FJX7333IHP/FJX7337IHP/FJX7457IHP) стр. 312). Циркуляция воздуха без нагрева и охлаждения.
	Активирует/деактивирует режим осушения (Режимы кондиционирования воздуха (только FJX4233EEN/FJX4333E(EN)/FJX7333IHP/FJX7337IHP/FJX7457IHP) стр. 312).





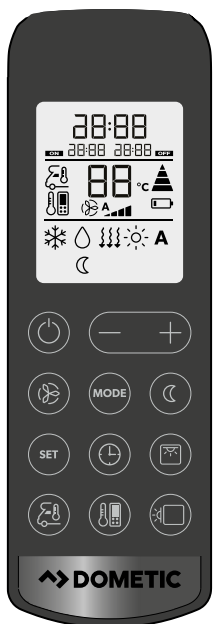









## 7.4 Пульт дистанционного управления FreshJet FJX4233EEN/FJX4333E(EH)/FJX7333INP/FJX7337INP/FJX7457INP

4





Элементы управления и индикации рис. 4 стр. 310:

Кнопка	Наименование
—	<p><b>Дисплей</b></p> <p>Индикация следующих параметров:</p> <ul style="list-style-type: none"> <li>• Время</li> <li>• Выбранная температура салона (целевое значение) в °C</li> <li>• Действительная температура в помещении</li> <li>• Режим кондиционирования воздуха</li> <li>• Частота вращения вентилятора</li> <li>• Символы активных дополнительных функций</li> <li>• Статус батареи</li> </ul>
⏻	Включает кондиционер или переключает его в режим ожидания.
⊕	Увеличивает текущее отображаемое значение.
⊖	Уменьшает текущее отображаемое значение.

Кнопка	Наименование
	Выбирает скорость вентилятора (Выбор скорости вентилятора вручную стр. 316).
	Выбирает режим кондиционирования (Режимы кондиционирования воздуха (только FJX4233EEN/ FJX4333E(EN)/FJX7333INP/FJX7337INP/FJX7457INP) стр. 312). Отображается соответствующий символ.
	Активирует функцию «сон» (Дополнительные функции (только FJX4233EEN/FJX4333E(EN)/FJX7333INP/ FJX7337INP/FJX7457INP) стр. 312). Отображается символ 
	Подтверждает и сохраняет настройки.
	Настраивает таймер и часы.
	Включает или выключает окружающее освещение в воздухораспределителе.
	Нажмите один раз, чтобы отобразить текущую температуру в салоне. Отображается символ  . Нажмите дважды, чтобы отобразить заданную температуру.
	Активирует функцию «I feel». Отображается символ  . Каждые 10 мин функция «I feel» настраивает целевую температуру в соответствии с фактической температурой, измеренной с помощью пульта дистанционного управления.
	Включает или выключает окружающее освещение в кондиционере.
	Показывает, что батарейки пульта дистанционного управления разряжены. Замените батарейки (Замена батареек в пульте дистанционного управления стр. 319).
	Показывает, что пульт дистанционного управления передает значения на кондиционер.





## 7.5 Режим кондиционирования воздуха (только FJX4233M)

Накрышный кондиционер имеет следующие режимы кондиционирования:

Режим кондиционирования воздуха	Символ на дисплее	Наименование
Охлаждение		Вы устанавливаете температуру и настройки вентилятора, а кондиционер охлаждает салон до этой температуры.
Вентиляция		Вы задаете настройки вентилятора, а кондиционер обеспечивает циркуляцию воздуха без нагрева или охлаждения.

## 7.6 Режимы кондиционирования воздуха (только FJX4233EEN/FJX4333E(EH)/FJX7333INP/FJX7337INP/FJX7457INP)

Накрышный кондиционер имеет следующие режимы кондиционирования:

Режим кондиционирования воздуха	Символ на дисплее	Наименование
Автоматический	<b>A</b>	Вы устанавливаете температуру, и кондиционер доводит салон до этой температуры путем нагрева или охлаждения и путем управления необходимой скоростью вентилятора.
Охлаждение		Вы устанавливаете температуру и настройки вентилятора, а кондиционер охлаждает салон до этой температуры.
Нагрев		<b>Не для FJX4333E:</b> Вы устанавливаете температуру и настройки вентилятора, а кондиционер нагревает салон до этой температуры. Вентилятор запускается только через 2 мин (на низкой скорости (Low), а затем примерно через 5 мин переходит на установленную скорость (после того, как испаритель достигнет нужной температуры).
Вентиляция		Вы задаете настройки вентилятора, а кондиционер обеспечивает циркуляцию воздуха без нагрева или охлаждения.
Удаление влаги		Кондиционер удаляет влагу из воздуха, не нагревая и не охлаждая салон, тем самым снижая относительную влажность воздуха.
Воздухоочиститель		<b>Не для FJX4333E:</b> Кондиционер ионизирует воздух, тем самым собирая из воздуха пыль и частицы, в том числе вирусы и бактерии.

## 7.7 Дополнительные функции (только FJX4233EEN/FJX4333E(EH)/FJX7333INP/FJX7337INP/FJX7457INP)

Накрышный кондиционер имеет следующие дополнительные функции:

Дополнительная функция	Сообщение на дисплее	Наименование
Таймер		Кондиционер включается в установленный момент времени.
		Кондиционер выключается в установленный момент времени.
		Кондиционер включается и снова выключается в установленные моменты времени.
Сон		Функция сна снижает скорость вращения вентилятора и компрессора, чтобы уменьшить уровень шума для комфортного сна.



Дополнительная функция	Сообщение на дисплее	Наименование
I Feel		Пульт дистанционного управления измеряет температуру в помещении и передает результат этого измерения в накрывной кондиционер каждые 10 мин. Накрывной кондиционер регулирует целевое значение в зависимости от этого результата измерения.
Soft Start		<b>Не для FJX4233EEN:</b> Пиковый ток, возникающий при пуске компрессора, уменьшается с помощью функции плавного пуска. Если в качестве источника питания используется генератор, он не перегружается.

## 8 Перед первым использованием

### Контроль перед вводом в эксплуатацию

Перед включением кондиционера учитывайте следующее:

1. Проверьте, соответствуют ли напряжение и частота питания значениям, указанным в Технические характеристики стр. 327.
2. Убедитесь в том, что не перекрыты ни воздухозаборные отверстия, ни воздушные сопла. Все вентиляционные решетки должны всегда оставаться свободными, чтобы кондиционер мог работать с максимальной производительностью.

### Подготовка пульта дистанционного управления (только FreshJet FJX4233EEN/FJX4333E(E-N)/FJX7333IHP/FJX7337IHP/FJX7457IHP)

3. Вставьте батарейки (Замена батареек в пульт дистанционного управления стр. 319).

### Установка времени (только FreshJet FJX4233EEN/FJX4333E(EH)/FJX7333IHP/FJX7337IHP/FJX7457IHP)

4. Установите текущее время (Установка текущего времени стр. 316).

## 9 Эксплуатация

### 9.1 Советы по наиболее эффективному использованию

Следующие советы помогут оптимизировать работу вашего накрывного кондиционера:

- Улучшите теплоизоляцию автомобиля, уплотнив зазоры и завесив окна отражающими шторками или занавесами.
- Выбирайте соразмерную температуру и режим работы вентилятора.
- Направьте воздушные сопла целесообразным образом.
- Следите за тем, чтобы воздушные сопла и воздухозаборные отверстия не перекрывались салфетками, бумагой или другими предметами.
- **Только FreshJet FJX4233EEN/FJX4333E(EH)/FJX7333IHP/FJX7337IHP/FJX7457IHP:** Если автомобиль долгое время подвергался воздействию прямых солнечных лучей: Включите накрывной кондиционер в режиме «Вентиляция» (☼☼☼) с открытыми окнами на некоторое время, прежде чем включить режим «Охлаждение» (❄️).

- **Только FreshJet FJX4233EEN/FJX4333E(EH)/FJX7333IHP/FJX7337IHP/FJX7457IHP:** Не открывайте двери и окна как можно дальше в режиме «Охлаждение» (❄️).

## 9.2 Общие указания по управлению

Накрышный кондиционер FreshJet FJX4233M имеет три режима работы:

Режим работы	Наименование
Выключено	Кондиционер выключен.
Охлаждение	Накрышный кондиционер охлаждает салон.
Вентиляция	Накрышный кондиционер обеспечивает циркуляцию воздуха без охлаждения.

Накрышный кондиционер FreshJet FJX4233EEN/FJX4333E(EH)/FJX7333IHP/FJX7337IHP/FJX7457IHP имеет два режима работы:

Режим работы	Наименование
Режим ожидания	Кондиционер готов к работе и может быть включен пультом дистанционного управления. Окружающее освещение доступно. Пульт дистанционного управления также находится в режиме ожидания, но вы можете включить его независимо от кондиционера.
Включен	Накрышный кондиционер кондиционирует воздух в салоне.

## 9.3 Dometic FJX4233M

Приведенная в этой главе информация относится только к накрышным кондиционерам FJX4233M.

### 9.3.1 Включение и выключение кондиционера

Накрышный кондиционер имеет два режима кондиционирования:





- Режим «Вентиляция» (🌀)
- Режим «Охлаждение» (❄️)



**Указание** Прежде чем переключаться из режима вентиляции в режим охлаждения или наоборот, подождите не менее 30 с. В противном случае ток переключения может привести к перегоранию предохранителя.

Каждый режим имеет три настройки:

- ..: Низкая
- ...: Средняя
- ....: Высокая

- > Чтобы включить, поверните ручку  в положение режима «Вентиляция»  или в положение режима «Охлаждение»  и выберите нужную настройку.
- ✓ Кондиционер включается и работает со значениями, которые были установлены перед выключением.
- > Для выключения поверните ручку  в положение 0.

### 9.3.2 Настройка температуры

- > Поверните ручку  в требуемое положение. Поворот ручки по часовой стрелке означает более низкую температуру.
- ✓ Температура в кондиционере настроена.

## 9.4 FreshJet FJX4233EEH/FJX4333E(EH)/FJX7333IHP/FJX7337IHP/FJX7457IHP

Приведенная в этой главе информация относится только к накрывным кондиционерам FreshJet FJX4233EEH/FJX4333E(EH)/FJX7333IHP/FJX7337IHP/FJX7457IHP.



### 9.4.1 С пульта дистанционного управления

При использовании пульта дистанционного управления учитывайте следующие советы:

- Направьте пульт дистанционного управления на ИК-приемник панели управления.
- При нажатии кнопки соответствующие настройки и значения передаются непосредственно на кондиционер.
- Накрывной кондиционер подтверждает получение данных звуковым сигналом.
- Значения увеличиваются или уменьшаются быстрее, если вы нажимаете и удерживаете кнопку + или -.
- В режиме ожидания дисплей пульта дистанционного управления также неактивен. Вы можете перевести пульт дистанционного управления в режим ожидания независимо от кондиционера.
- > Чтобы переключить только пульт дистанционного управления в режим ожидания или из режима ожидания, нажмите кнопку , не направляя пульт на ИК-приемник панели управления.

### 9.4.2 Включение кондиционера и переключение в режим ожидания

 **Указание** Когда кондиционер включается, он работает со значениями, которые были установлены перед переключением в режим ожидания. Накрывной кондиционер можно выключить только путем отключения электропитания.

- > Нажмите кнопку  на пульте дистанционного управления или кнопку  на панели управления, чтобы включить кондиционер или переключить его в режим ожидания.

### 9.4.3 Выбор режима кондиционирования

- > Выберите нужный режим кондиционирования, используя кнопку MODE (Режимы кондиционирования воздуха (только FJX4233EEH/FJX4333E(EH)/FJX7333IHP/FJX7337IHP/FJX7457IHP) стр. 312).
- ✓ Накрывной кондиционер подтверждает получение значений звуковым сигналом. Кондиционер включается в выбранный режим кондиционирования.

### 9.4.4 Выбор скорости вентилятора вручную

Во всех режимах, кроме режимов «Автоматический» (A) и «Удаление влаги» (☉), скорость вентилятора можно выбрать вручную.

Сообщение на дисплее	Наименование
	Низкий уровень мощности вентилятора
	Средний уровень мощности вентилятора
	Высокий уровень мощности вентилятора.
	Турбо-уровень мощности вентилятора.
	Автоматический режим (скорость вентилятора регулируется в зависимости от температуры окружающей среды).

- > Нажмите кнопку (⊗) пульта дистанционного управления или кнопку (⊗) панели управления, чтобы выбрать требуемую частоту вращения вентилятора.
- ✓ Накрышный кондиционер подтверждает получение значений звуковым сигналом.

Скорость работы вентилятора настроена заново.

### 9.4.5 Настройка температуры

В режимах «Автоматический» (A), «Охлаждение» (❄), «Обогрев» (☀) и «Удаление влаги» (☉) вы можете настроить температуру в диапазоне от 16 °C до 31 °C.

- > Используйте кнопку + или – на пульте дистанционного управления, чтобы установить требуемую температуру.
- ✓ Накрышный кондиционер подтверждает получение значений звуковым сигналом. Температура в кондиционере настроена.

### 9.4.6 Установка текущего времени

Для программирования таймера пульта дистанционного управления требуется точное время. Значение времени отображается на дисплее пульта дистанционного управления.

1. Нажмите и удерживайте кнопку (⌚), чтобы перейти в режим установки времени.
- ✓ Значение времени начнет мигать на дисплее пульта.
2. Чтобы изменить текущее время, нажмите кнопки + или –. Нажмите и удерживайте кнопку + или – дольше 2 с, чтобы быстрее увеличить или уменьшить время.
3. Чтобы подтвердить значение времени, нажмите кнопку SET.





### 9.4.7 Программирование таймера





Используя функцию таймера, вы можете настроить требуемый период времени кондиционирования. Вы можете задать момент включения, момент выключения, либо оба значения.







Функция таймера устанавливается с пульта дистанционного управления.







**Указание** Если при программировании таймера в течении 15 с не нажимать ни одну из кнопок на пульте дистанционного управления, то пульт автоматически возвращается в исходный режим.

- > Установите **таймер включения** следующим образом:
  - a) Выберите требуемый режим кондиционирования и все необходимые значения (например, температуру).
  - b) При необходимости, переключите кондиционер в режим ожидания.  
Таймер включения можно установить только тогда, когда кондиционер находится в **режиме ожидания**.
  - c) Нажмите кнопку  один раз.
  - ✓ Символ   начнет мигать на дисплее пульта.
  - d) Используйте кнопку + или -, чтобы установить время включения кондиционера.
  - e) Нажмите кнопку .

Таймер включения установлен. Кондиционер включается с выбранным режимом кондиционирования в указанное время.
- > Установите **таймер переключения в режим ожидания** следующим образом:
  - a) При необходимости, включите кондиционер.  
Таймер переключения в режим ожидания можно установить только тогда, когда кондиционер **включен**.
  - b) Нажмите кнопку  два раза.
  - ✓ Символ   начнет мигать на дисплее пульта.
  - c) Используйте кнопку + или -, чтобы установить время переключения кондиционера в режим ожидания.
  - d) Нажмите кнопку .

Таймер переключения в режим ожидания установлен. Кондиционер переключается в режим ожидания в указанное время.
- > Установите **таймер включения и таймер переключения в режим ожидания** следующим образом:
  - a) Выберите требуемый режим кондиционирования и все необходимые значения (например, температуру).
  - b) Нажмите кнопку  три раза.
  - ✓ На дисплее пульта дистанционного управления отображается символ    . Символ ON мигает.
  - c) Используйте кнопку + или -, чтобы установить время включения кондиционера.
  - d) Нажмите кнопку .
  - ✓ Символ **OFF** мигает.
  - e) Используйте кнопку + или -, чтобы установить время переключения кондиционера в режим ожидания.
  - f) Нажмите кнопку .

✓ Значения времени включения и времени переключения в режим ожидания установлены. Кондиционер включается на определенный период времени.
- > Чтобы **отменить** предустановленный таймер, нажмите кнопку  один раз.
- ✓ Символы     исчезают. Предустановленные значения отменяются.

### 9.4.8 Настройка функции сна

Функция сна доступна только в режимах «Охлаждение» (❄️) или «Обогрев» (☀️).

функция сна ограничивает скорость вентилятора более низким уровнем, чтобы снизить уровень шума в целях облегчения сна.

**Только FJX7333INP/FJX7337INP/FJX7457INP:** Функция сна дополнительно ограничивает скорость компрессора.

- > Для активирования функции сна соблюдайте следующий порядок действий:
  - a) Установите необходимую температуру (Настройка температуры стр. 316).
  - b) Нажмите кнопку (⌚) на пульте дистанционного управления или кнопку (⌚) на панели управления.
- ✓ На дисплее пульта дистанционного управления появляется символ (☾). Функция сна активирована.
  - > Чтобы деактивировать функцию сна, нажмите кнопку (⌚) или (⌚) на пульте дистанционного управления или кнопку (☾) на панели управления.
- ✓ На дисплее пульта дистанционного управления исчезает символ (☾). Функция сна деактивирована.

### 9.4.9 Активация функции «I feel»

Если эта функция активна, пульт дистанционного управления измеряет температуру в помещении и передает результат этого измерения в накрывший кондиционер каждые 10 минут. Накрывший кондиционер регулирует целевое значение в зависимости от этого результата измерения. Функция «I feel» активна только в диапазоне температур от +18 °C до +29 °C.

Не класть пульт дистанционного управления в части помещения, где температура значительно отличается от средней. Его нельзя, например, оставлять на солнце или перед накрывшим кондиционером.

Когда температура поднимается выше +29 °C или опускается ниже +18 °C, функция «I feel» деактивируется.

Символ (📶) трижды мигает на дисплее, а затем гаснет.

1. Нажмите кнопку.
- ✓ Функция «I feel» активирована.

На дисплее появляется символ (📶).

2. Расположите пульт дистанционного управления так, чтобы он был направлен на ИК-приемник на панели управления. В противном случае значения не могут быть переданы в накрывший кондиционер.

### 9.4.10 Управление окружающим освещением







**ПРЕДУПРЕЖДЕНИЕ! Опасность получения травм** По закону запрещается использовать внешние огни при управлении транспортным средством.

Кнопка (📶) на пульте дистанционного управления активна, даже если пульт дистанционного управления выключен.

**Только FreshJet FJX4233EEN/FJX4333E(EN)/FJX7333INP/FJX7337INP/FJX7457INP:**

- > Чтобы включить или выключить внутреннее освещение, нажмите кнопку (📶) на пульте дистанционного управления или на панели управления.
- ✓ Символ (📶) мигает один раз на дисплее пульта дистанционного управления, когда внутреннее освещение **включено**.

- > Чтобы приглушить внутреннее освещение, выполните следующие действия:
  - a) Нажмите кнопку  на пульте дистанционного управления или на панели управления на 3 с.
  - b) При нажатии кнопки  на пульте дистанционного управления: Нажмите кнопку , чтобы приглушить внутренний свет между 50 % и 100 %.
  - c) При нажатии кнопки  на панели управления: Яркость внутреннего освещения меняется между 50 % и 100 %. Отпустите кнопку , когда будет достигнута требуемая яркость.

#### Только FreshJet FJX7333INP/FJX7337INP/FJX7457INP:

- > Чтобы включить или выключить внешнее освещение, нажмите кнопку  на панели управления.

### 9.4.11 Замена батареек в пульте дистанционного управления



**Указание** Дисплей пульта дистанционного управления остается по-прежнему ярким, даже если батарейки разряжены. Замените батарейки, когда пульт дистанционного управления покажет, что батарейки разряжены.

- > Замените батарейки, как показано на рисунке.

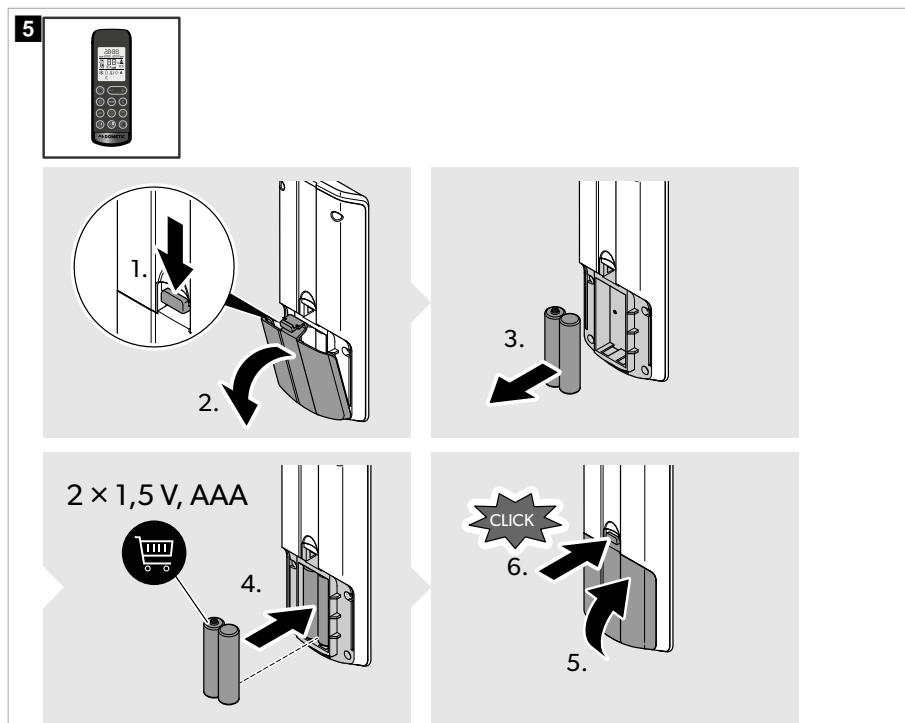

- ✓ На дисплее отображаются все символы в течение 5 с.



Защищайте окружающую среду! Аккумуляторы и батареи запрещается выбрасывать в бытовой мусор. Неисправные аккумуляторы и разряженные батареи сдавайте в торговую организацию или в специальные сборные пункты.

## 9.5 Регулирование подачи воздуха внутри транспортного средства

Поток воздуха можно настроить вдоль потолка или по направлению к полу.

- > Поверните ламели в воздушных соплах независимо друг от друга в нужных направлениях.

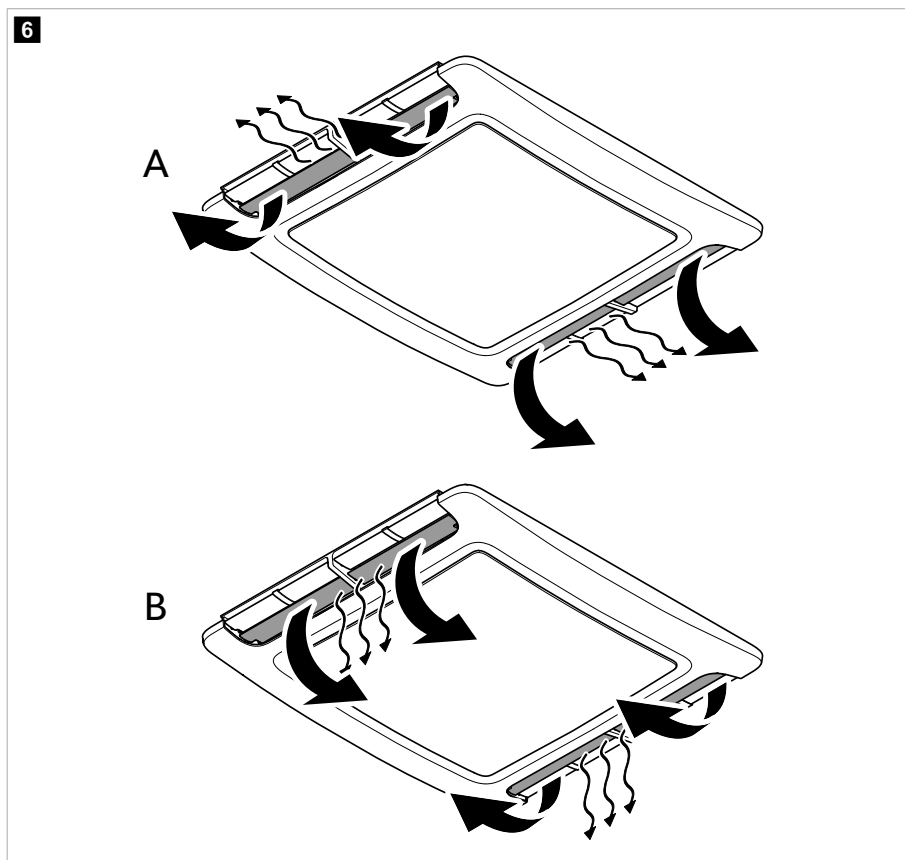



## 10 Очистка накрывного кондиционера



### ВНИМАНИЕ! Риск повреждения

- Не используйте средства для ускорения процесса размораживания или очистки, кроме тех, которые рекомендованы изготовителем.
- Категорически запрещается очищать кондиционер очистителем высокого давления. Попавшая вода может привести к повреждениям кондиционера.
- Не используйте для очистки острые или твердые предметы или чистящие средства, которые могут повредить кондиционер.
- Категорически запрещается использовать бензин, дизельное топливо или растворители.

1. Регулярно удаляйте листья и другие загрязнения с воздухозаборника и вентиляционных решеток накрывного кондиционера. Не допускайте повреждений вентиляционных решеток.

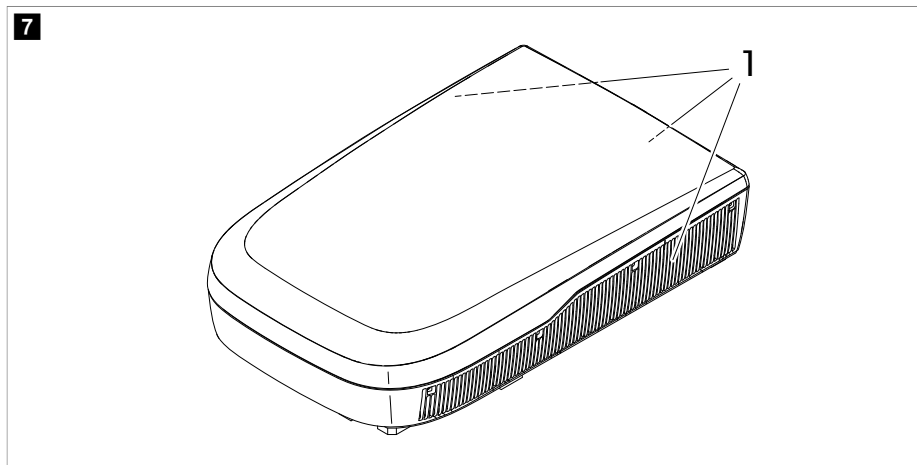

2. Периодически очищайте корпуса кондиционера и воздухораспределителя влажной тряпкой. Используйте только воду с мягким моющим средством.
3. **Только FreshJet FJX4233EEN/FJX4333E(EN)/FJX73331NP/FJX73371NP/FJX74571NP:** Периодически очищайте пульт дистанционного управления слегка влажной тряпкой. Очищайте дисплей салфеткой для очистки очков.
4. **Только FreshJet FJX4233EEN/FJX4333E(EN)/FJX73331NP/FJX73371NP/FJX74571NP** Периодически очищайте дисплей воздухораспределителя мягким раствором теплой мыльной воды. Экран дисплея изготовлен из акрила и может быть поврежден некоторыми обычными бытовыми химикатами, такими как химические чистящие средства, средства для мытья окон, спирт, некоторые поверхностно-активные вещества, органические растворители и смягчители.

## 11 Уход и обслуживание

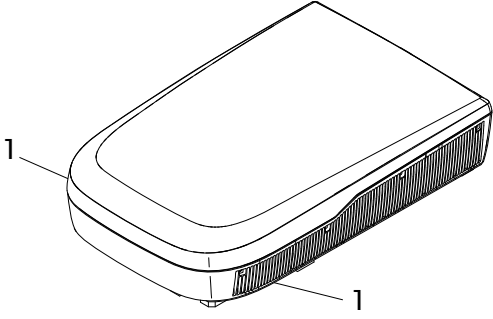
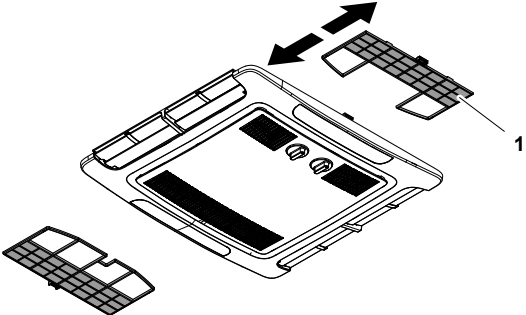

**ПРЕДУПРЕЖДЕНИЕ! Опасность получения травм** Другие работы по техническому обслуживанию, не описанные здесь, разрешается выполнять только специалистам, знакомым с опасностями при обращении с хладагентами и кондиционерами, а также с соответствующими стандартами и предписаниями.

Интервал	Проверка/техническое обслуживание
Регулярно	<p>Проверьте, свободны ли каналы для слива конденсата (1) по бокам кондиционера и возможен ли слив конденсата.</p> <div data-bbox="333 437 1016 804" style="border: 1px solid black; padding: 10px;"> <p><b>8</b></p>  </div>
Regularly (FreshJet FJX4233M)	<p>Очистка фильтра модуля выхода воздуха:</p> <div data-bbox="333 871 1016 1235" style="border: 1px solid black; padding: 10px;"> <p><b>9</b></p>  </div> <ol style="list-style-type: none"> <li>1. Снимите фильтр (1).</li> <li>2. Очистите фильтр (1) раствором моющего средства и дайте ему высохнуть.</li> <li>3. Вставьте сухой фильтр (1) на место.</li> </ol>

Интервал	Проверка/техническое обслуживание
<p>Регулярно (FreshJet FJX4233EEN/FJX4333E(E-N)/FJX73331HP/FJX73371HP/FJX74571HP)</p>	<ul style="list-style-type: none"> <li>Очистка фильтра модуля выхода воздуха:           <div data-bbox="367 225 1016 528" style="border: 1px solid black; padding: 5px; margin: 10px 0;"> <p><b>10</b></p>  </div> <ol style="list-style-type: none"> <li>Вставьте плоскую отвертку или нож в ручку (1), чтобы вытянуть фильтры (2)</li> <li>Снимите фильтры вручную.</li> <li>Очистите фильтры раствором моющего средства и дайте им высохнуть.</li> <li>Вставьте сухие фильтры обратно рис. 10 стр. 323</li> </ol> </li> <li>Доверьте выполнение технического обслуживания теплообменника специализированной компании.</li> </ul>
<p>Один раз в год</p>	<ul style="list-style-type: none"> <li>Проверьте уплотнения между кондиционером и крышей автомобиля на наличие трещин и других повреждений.</li> <li>Убедитесь, что крепежные болты затянуты с правильным моментом затяжки (2.5 нм ± 0.3 нм) и, при необходимости, отрегулируйте.</li> </ul>

## 12 Устранение неисправностей

Неисправность	Возможные причины	Вариант устранения
<p>Плохое охлаждение</p>	<p>Кондиционер не настроен на охлаждение.</p>	<p>Настройте кондиционер на охлаждение.</p>
	<p>Окружающая температура превышает 52 °С.</p>	<p>Накрышный кондиционер рассчитан только на окружающие температуры до 52 °С.</p>
	<p>Настроенная температура выше температуры в помещении.</p>	<p>Выберите более низкую температуру.</p>
	<p>Окружающая температура ниже 16 °С.</p>	<p>Накрышный кондиционер предназначен для охлаждения только при температуре окружающей среды выше 16 °С.</p>
	<p>Неисправен один из датчиков температуры.</p>	<p>Свяжитесь с уполномоченным сервисным центром или компанией Dometic.</p>

Неисправность	Возможные причины	Вариант устранения
	Неисправен вентилятор испарителя.	Свяжитесь с уполномоченным сервисным центром или компанией Dometic.
	Неисправен вентилятор конденсатора.	Свяжитесь с уполномоченным сервисным центром или компанией Dometic.
<b>Только FreshJet FJX4233EEN/ FJX4333E(EN)/FJX7333INP/ FJX73337INP/FJX7457INP:</b> Плохой обогрев	Кондиционер не настроен на обогрев.	Настройте кондиционер на обогрев.
	Окружающая температура ниже $-2^{\circ}\text{C}$ .	Накрышный кондиционер предназначен только для работы при температуре окружающей среды выше $-2^{\circ}\text{C}$ .
	Настроенная температура ниже температуры в помещении.	Выберите более высокую температуру.
	Неисправен один из датчиков температуры.	Свяжитесь с уполномоченным сервисным центром или компанией Dometic.
	Неисправен вентилятор испарителя.	Свяжитесь с уполномоченным сервисным центром или компанией Dometic.
Низкий выход воздуха	Воздухозаборные отверстия заблокированы или перекрыты.	Удалите листья и другие загрязнения с вентиляционных отверстий на кондиционере.
	Неисправен вентилятор.	Свяжитесь с уполномоченным сервисным центром или компанией Dometic.
Попадание воды в автомобиль	Засорены отверстия для отвода конденсата.	Очистите отверстия для отвода конденсата.
	Повреждены уплотнения.	Свяжитесь с уполномоченным сервисным центром или компанией Dometic.
Кондиционер не включается.	Не подключен источник питания.	Проверьте электропитание.
	Слишком низкое напряжение ( $< 200\text{ В}$ ).	Свяжитесь с уполномоченным сервисным центром или компанией Dometic.
	Неисправен трансформатор напряжения.	Свяжитесь с уполномоченным сервисным центром или компанией Dometic.
	Неисправен один из датчиков температуры.	Свяжитесь с уполномоченным сервисным центром или компанией Dometic.

Неисправность	Возможные причины	Вариант устранения
	Электрический предохранитель источника питания слишком слабый.	Свяжитесь с уполномоченным сервисным центром или компанией Dometic.
Кондиционер не выключается.	Неисправен один из датчиков температуры.	Свяжитесь с уполномоченным сервисным центром или компанией Dometic.
	Электрический предохранитель источника питания слишком слабый.	Свяжитесь с уполномоченным сервисным центром или компанией Dometic.
<b>Только FreshJet FJX4233EEN/ FJX4333E(EH)/FJX7333INP/ FJX7337INP/FJX7457INP:</b> Кондиционер постоянно отключается.	Сработал сигнализатор обледенения.	Наружная температура слишком низкая или все воздушные сопла закрыты.
На дисплее появляется: P0	Перегрев или перегрузка по току на модуле IPM	Свяжитесь с уполномоченным сервисным центром или компанией Dometic.
На дисплее появляется: P1	Защита от пониженного напряжения	Свяжитесь с уполномоченным сервисным центром или компанией Dometic.
На дисплее появляется: P2	Защита от перегрузки по току блока кондиционера	Свяжитесь с уполномоченным сервисным центром или компанией Dometic.
На дисплее появляется: P4	Защита от перегрева выпускной трубы	Свяжитесь с уполномоченным сервисным центром или компанией Dometic.
На дисплее появляется: P5	Защита змеевика испарителя (режим охлаждения)	Свяжитесь с уполномоченным сервисным центром или компанией Dometic.
На дисплее появляется: P6	Защита змеевика конденсатора (режим охлаждения)	Свяжитесь с уполномоченным сервисным центром или компанией Dometic.
На дисплее появляется: P7	Защита змеевика испарителя (режим нагрева)	Свяжитесь с уполномоченным сервисным центром или компанией Dometic.
На дисплее появляется: P9	Неисправный привод компрессора или компрессор не запускается	Свяжитесь с уполномоченным сервисным центром или компанией Dometic.
На дисплее появляется: E0	Сбой связи	Свяжитесь с уполномоченным сервисным центром или компанией Dometic.
На дисплее появляется: E1	Неисправность датчика температуры помещения	Свяжитесь с уполномоченным сервисным центром или компанией Dometic.

Неисправность	Возможные причины	Вариант устранения
На дисплее появляется: E2	Неисправность датчика температуры змеевика испарителя	Свяжитесь с уполномоченным сервисным центром или компанией Dometic.
На дисплее появляется: E3	Неисправность датчика температуры змеевика конденсатора	Свяжитесь с уполномоченным сервисным центром или компанией Dometic.
На дисплее появляется: E7	Неисправность датчика температуры наружного воздуха	Свяжитесь с уполномоченным сервисным центром или компанией Dometic.
На дисплее появляется: E8	Неисправность датчика температуры выпускной трубы	Свяжитесь с уполномоченным сервисным центром или компанией Dometic.
На дисплее появляется: E9	Неисправность привода компрессора или модуля IPM	Свяжитесь с уполномоченным сервисным центром или компанией Dometic.
На дисплее появляется: EA	Неисправность датчика тока	Свяжитесь с уполномоченным сервисным центром или компанией Dometic.
На дисплее появляется: EE	Неисправность внешнего ЭСППЗУ	Свяжитесь с уполномоченным сервисным центром или компанией Dometic.
На дисплее появляется: EL	Сбой связи LIN-BUS/CI-BUS	Свяжитесь с уполномоченным сервисным центром или компанией Dometic.

## 13 Утилизация



По возможности, выкидывайте упаковочный материал в мусор, подлежащий вторичной переработке. Выясните в ближайшем центре по вторичной переработке или в торговой сети о соответствующих предписаниях по утилизации изделия.



Защищайте окружающую среду! Аккумуляторы и батареи запрещается выбрасывать в бытовой мусор. Неисправные аккумуляторы и разряженные батареи сдавайте в торговую организацию или в специальные сборные пункты.

## 14 Гарантия

Действителен установленный законом срок гарантии. Если продукт неисправен, обратитесь в представительство изготовителя в вашей стране (см. [dometic.com/dealer](http://dometic.com/dealer)) или в торговую организацию.

При обращении по вопросу ремонта или гарантийного обслуживания необходимо также предоставить следующую информацию:

- копию счета с датой покупки

- причину претензии или описание неисправности

Учтите, что самостоятельно выполненный или непрофессиональный ремонт могут иметь последствия для безопасности и привести к аннулированию гарантии.

## 15 Технические характеристики

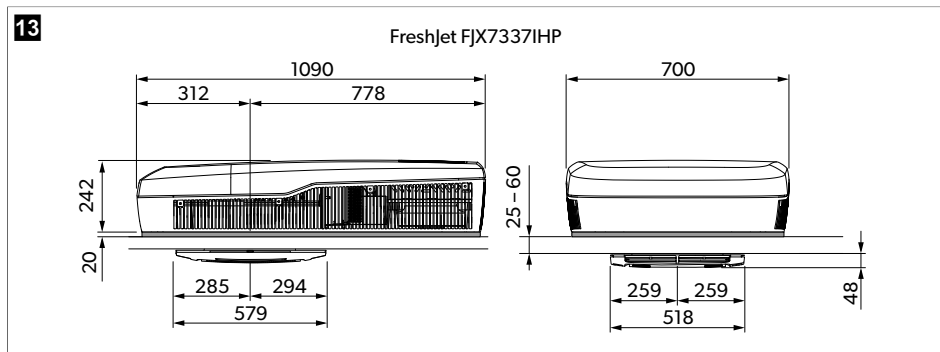
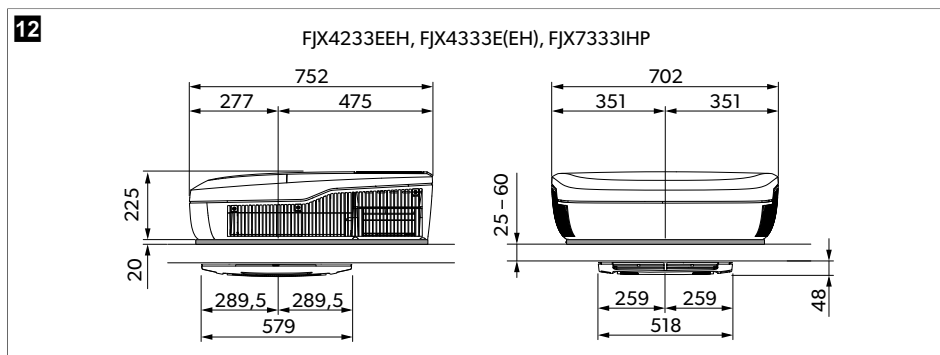
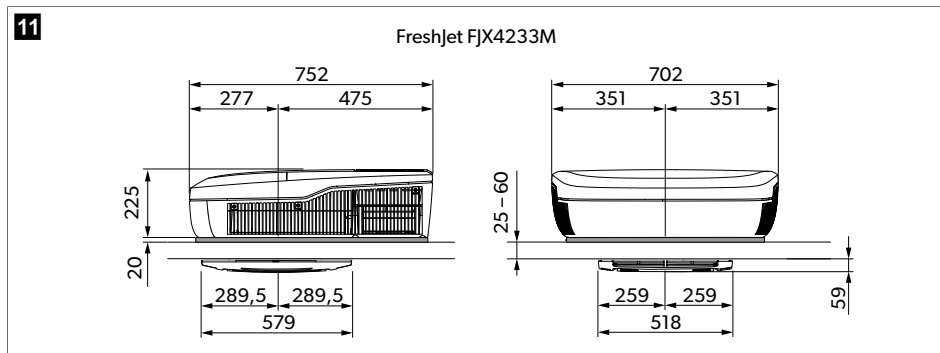

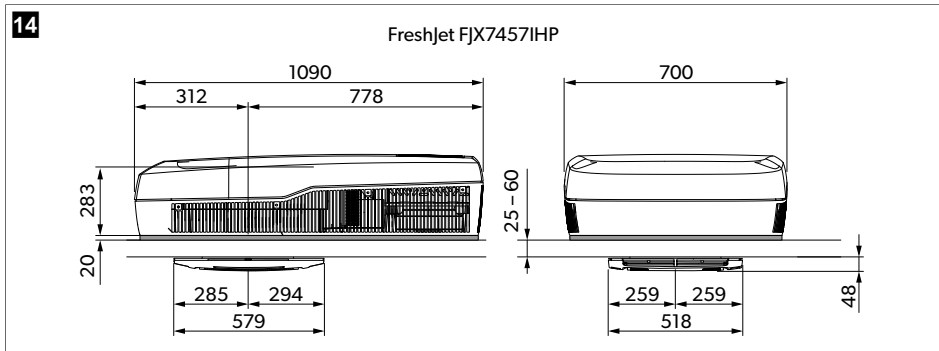



Содержит фторированные парниковые газы. Герметичное оборудование.

	<b>FreshJet FJX4233M</b>
Холодопроизводительность согласно ISO 5151:	1500 Вт
Входное напряжение переменного тока:	220 В ... 240 В / 50 Гц
Номинальный ток при охлаждении:	< 3.3 А
Требуемый предохранитель:	4 А
Диапазон рабочих температур:	- 2 °С ... 52 °С
Хладагент:	R410a
Количество хладагента:	380 г
CO <sub>2</sub> -эквивалент:	0.793 т
Потенциал глобального потепления (GWP):	2088
Класс защиты (накрышный блок):	IPX4
Уровень шума (максимальная настройка вентилятора)	< 70 дБ(А)
Рекомендуемая макс. длина автомобиля (с изолированными стенами):	< 5 м
Размеры (Д x Ш x В):	рис. <b>11</b> стр. 327
Вес:	< 30 кг



	FreshJet FJX4233M		
Испытания/сертификат:			
	FreshJet FJX4233EEH	FreshJet FJX4333EEH	FreshJet FJX4333E
Холодопроизводительность согласно ISO 5151:	1700 Вт	2200 Вт	2200 Вт
Теплопроизводительность согласно ISO 5151:	800 Вт	1000 Вт	–
Входное напряжение переменного тока:	220 В ... 240 В / 50 Гц		
Номинальный ток при охлаждении:	3.6 А	4.8 А	4.8 А
Номинальный ток при обогреве:	< 5.2 А	< 5.2 А	–
Требуемый предохранитель:	4 А	5 А	6 А
Диапазон рабочих температур:	– 2 °С ... 52 °С		
Хладагент:	R32		
Количество хладагента:	320 г	360 г	360 г
СО <sub>2</sub> -эквивалент:	0.216 т	0.243 т	0.243 т
Потенциал глобального потепления (GWP):	675		
Класс защиты (накрышный блок):	IPX4		
Уровень шума (максимальная настройка вентилятора)	< 70 дБ(А)		
Рекомендуемая макс. длина автомобиля (с изолированными стенами):	< 6 м	< 7 м	< 7 м
Размеры (Д x Ш x В):	рис. 12 стр. 327		
Вес:	< 30 кг	< 30 кг	< 30 кг
Испытания/сертификат:			

	Freshjet FJX7333IHP	Freshjet FJX7337IHP	Freshjet FJX7457IHP
Холодопроизводительность согласно ISO 5151:	2200 Вт	3000 Вт	3500 Вт
Теплопроизводительность согласно ISO 5151:	2000 Вт	2500 Вт	3000 Вт
Входное напряжение переменного тока:	220 В ... 240 В / 50 Гц ... 60 Гц	220 В ... 240 В / 50 Гц ... 60 Гц	220 В ... 240 В / 50 Гц ... 60 Гц
Номинальный ток при охлаждении:	< 7.5 А	< 7.5 А	< 7.5 А
Номинальный ток при обогреве:	< 6.1 А	< 6.1 А	< 6.1 А
Требуемый предохранитель:	6 А	6 А	6 А
Диапазон рабочих температур:	- 2 °С ... 52 °С	- 2 °С ... 52 °С	- 2 °С ... 52 °С
Хладагент:	R32	R32	R32
Количество хладагента:	420 г	480 г	650 г
СО <sub>2</sub> -эквивалент:	0.2835 т	0.3240 т	0.43875 т
Потенциал глобального потепления (GWP):		675	
Класс защиты (накрышный блок):		IPX4	
Уровень шума (максимальная настройка вентилятора)		< 70 дБ(А)	
Рекомендуемая макс. длина автомобиля (с изолированными стенами):	< 7 м	< 7 м	> 8 м
Размеры (Д x Ш x В):	рис. 12 стр. 327	рис. 13 стр. 327	рис. 14 стр. 328
Вес:	< 30 кг	< 35 кг	< 40 кг
Испытания/сертификат:			

## Polish

1	Important notes.....	331
2	Objaśnienie symboli.....	331
3	Wskazówki bezpieczeństwa.....	332
4	Użytkowanie zgodne z przeznaczeniem.....	333
5	Objaśnienie symboli na urządzeniu.....	334
6	Ograniczenia techniczne i warunki zastosowania.....	334
7	Opis techniczny.....	334
8	Przed pierwszym użyciem.....	340
9	Eksplatacja.....	340
10	Czyszczenie klimatyzatora dachowego.....	348
11	Konserwacja.....	348
12	Usuwanie usterek.....	350
13	Utylizacja.....	353
14	Gwarancja.....	353
15	Dane techniczne.....	354

## 1 Important notes

Prosimy o uważne przeczytanie niniejszej instrukcji i przestrzeganie wszystkich instrukcji, wskazówek i ostrzeżeń zawartych w niniejszej instrukcji produktu. Pozwoli to przez cały czas zapewnić prawidłową instalację, zastosowanie oraz konserwację produktu. Niniejsza instrukcja MUSI przez cały czas pozostawać przy produkcie.

Korzystając z produktu, użytkownik potwierdza uważne przeczytanie wszelkich instrukcji, wskazówek i ostrzeżeń, ich zrozumienie oraz zobowiązuje się przestrzegać zawartych w nich warunków. Użytkownik zobowiązuje się wykorzystywać niniejszy produkt wyłącznie zgodnie z jego przeznaczeniem i zamierzonym zastosowaniem oraz z instrukcjami, wskazówkami i ostrzeżeniami wyszczególnionymi w niniejszej instrukcji produktu, jak również ze wszystkimi mającymi zastosowanie przepisami i regulacjami prawnymi. Nieprzestrzeganie zawartych tu instrukcji i ostrzeżeń może skutkować obrażeniami u użytkownika oraz osób trzecich, uszkodzeniem produktu lub też uszkodzeniem mienia w sąsiedztwie produktu. Zastrzega się możliwość wprowadzania zmian i aktualizacji niniejszej instrukcji produktu, wraz z instrukcjami, wskazówkami i ostrzeżeniami oraz powiązaną dokumentacją. Aktualne informacje dotyczące produktu można zawsze znaleźć na stronie [documents.dometic.com](http://documents.dometic.com).

## 2 Objąśnienie symboli



**NIEBEZPIECZEŃSTWO!** Wskazuje niebezpieczną sytuację, która – jeśli się jej nie uniknie – prowadzi do śmierci lub poważnych obrażeń.



**OSTRZEŻENIE!** Wskazuje niebezpieczną sytuację, która – jeśli się jej nie uniknie – prowadzi do śmierci lub poważnych obrażeń.



**OSTROŻNIE!** Wskazuje niebezpieczną sytuację, która – jeśli się jej nie uniknie – może prowadzić do lekkich lub umiarkowanych obrażeń.



**UWAGA!** Wskazuje niebezpieczną sytuację, która – jeśli się jej nie uniknie – może prowadzić do lekkich lub umiarkowanych obrażeń.



**Wskazówka** Dodatkowe informacje dotyczące obsługi produktu.

### 3 Wskazówki bezpieczeństwa



**OSTRZEŻENIE! Nieprzestrzeganie tych ostrzeżeń może prowadzić do śmierci lub ciężkich obrażeń.**

- **Urządzenia elektryczne nie są zabawkami dla dzieci.** Urządzenie nie może być używane przez osoby (w tym dzieci) o ograniczonych możliwościach fizycznych, sensorycznych lub umysłowych, lub niedysponujące doświadczeniem i wiedzą, chyba że są one pod nadzorem lub zostały poinstruowane.
- Należy dopilnować, aby dzieci nie bawiły się urządzeniem.
- Dzieci od 8 lat i osoby o ograniczonych możliwościach fizycznych, sensorycznych lub intelektualnych oraz osoby niedysponujące stosowną wiedzą i doświadczeniem mogą używać tego urządzenia jedynie pod nadzorem innej osoby bądź pod warunkiem uzyskania informacji dotyczących bezpiecznego użytkowania urządzenia i zrozumienia wynikających z tego zagrożeń.
- Dzieci nie mogą czyścić urządzenia bez nadzoru.
- Każda osoba pracująca przy obiegu czynnika chłodniczego lub otwierająca go powinna posiadać aktualny, ważny certyfikat wydany przez akredytowaną w branży instytucję oceniającą kwalifikacje, który potwierdza jej kompetencje w zakresie bezpiecznego obchodzenia się z czynnikami chłodniczymi zgodnie z uznaną w branży specyfikacją oceny.
- Konserwacja powinna być wykonywana wyłącznie zgodnie z zaleceniami producenta urządzenia. Prace konserwacyjne i naprawy wymagające pomocy dodatkowego wykwalifikowanego personelu powinny być przeprowadzane pod nadzorem osoby kompetentnej w zakresie stosowania łatwopalnych czynników chłodniczych.
- Napraw urządzenia może dokonywać tylko odpowiednio wykwalifikowany personel, który jest świadomy potencjalnych zagrożeń i zna odpowiednie przepisy. Nieodpowiednio wykonane naprawy mogą być przyczyną poważnych zagrożeń. W celu naprawy należy zwrócić się do centrum serwisowego w danym kraju (patrz [dometic.com/dealer](http://dometic.com/dealer)).
- Przed przystąpieniem do prac przy urządzeniu należy zawsze odłączyć je od zasilania elektrycznego.
- Urządzenie należy przechowywać w pomieszczeniach bez stale aktywnych źródeł zapłonu, takich jak otwarte płomienie, pracujące urządzenia gazowe lub pracujące grzejniki elektryczne.
- Nie przedziurawiać ani nie podpalać urządzenia.
- Należy mieć świadomość faktu, że czynniki chłodnicze mogą być pozbawione zapachu.
- Nie umieszczać urządzenia w pobliżu łatwopalnych cieczy ani w zamkniętych pomieszczeniach.
- W pobliżu wylotu powietrza nie mogą składowane ani zamontowane być żadne łatwopalne przedmioty. Należy zachować od nich odstęp co najmniej 50 cm.
- Nie zastaniać otworów wentylacyjnych.
- Nie uszkodzić obiegu chłodniczego.
- Pod żadnym pozorem nie stosować potencjalnych źródeł zapłonu do lokalizacji lub wykrywania wycieków czynnika chłodniczego. Nie stosować palników do wykrywania czynników chłodniczych (ani żadnych innych detektorów wykorzystujących nieosłonięty płomień).
- Klimatyzator dachowy należy zamontować w pojeździe o powierzchni podłogi większej niż 4 m<sup>2</sup>.

**OSTROŻNIE! Nieprzestrzeganie tych uwag może prowadzić do lekkich lub umiarkowanych obrażeń.**

- Nie sięgać do wylotów powietrza i nie wkładać żadnych przedmiotów do urządzenia.
- W przypadku pożaru nie zdejmować górnej pokrywy urządzenia, tylko użyć atestowanych środków gaśniczych. Do gaszenia nie należy używać wody.
- Jeśli przewód zasilający ulegnie uszkodzeniu, aby uniknąć zagrożenia, należy zlecić jego wymianę przez producenta, centrum serwisowe lub odpowiednio wykwalifikowany personel.
- Jeżeli urządzenie wyposażone jest w jonizator, osoby ze schorzeniami powinny skonsultować możliwość jego wykorzystywania z lekarzem. Jonizator może wytwarzać małe ilości ozonu (O<sub>3</sub>). Osoby cierpiące na choroby płuc, astmę, choroby serca, choroby układu oddechowego, problemy z oddychaniem oraz osoby wrażliwe na ozon powinny skonsultować się z lekarzem i dowiedzieć się, czy mogą one bezpiecznie korzystać z urządzenia.

**UWAGA! Ryzyko uszkodzenia**

- Do przyspieszania procesu odszraniania i czyszczenia nie należy używać żadnych innych środków oprócz tych, które zaleca producent.
- Urządzenie należy przechowywać w taki sposób, aby nie dopuścić do powstania uszkodzeń mechanicznych.
- Nie należy dokonywać żadnych modyfikacji ani przebrojeń urządzenia.
- Nigdy nie wjeżdżać pojazdem z zamontowanym urządzeniem do automatycznych myjni samochodowych.
- W przypadku uszkodzenia obiegu czynnika chłodniczego, aby uniknąć zagrożenia, urządzenie musi zostać sprawdzone i naprawione przez producenta, jego centrum serwisowe lub odpowiednio wykwalifikowany personel.

## 4 Użytkowanie zgodne z przeznaczeniem

Klimatyzator dachowy FreshJet FJX jest przeznaczony wyłącznie do montażu na dachu przyczepy kempingowej lub pojazdu rekreacyjnego w celu zapewnienia chłodzenia.

Klimatyzator dachowy **nie** jest przeznaczony do stosowania w pociągach, domach ani mieszkaniach. Klimatyzator dachowy **nie** jest przeznaczony do instalacji w maszynach budowlanych, rolniczych itp.

Niniejszy produkt jest przystosowany wyłącznie do wykorzystywania zgodnie z jego przeznaczeniem oraz zamierzonym zastosowaniem według niniejszej instrukcji.

Niniejsza instrukcja zawiera informacje, które są niezbędne do prawidłowego montażu i/lub obsługi produktu. Nieprawidłowy montaż i/ lub niewłaściwa obsługa lub konserwacja powodują niezadowolające działanie i mogą prowadzić do uszkodzeń.

Producent nie ponosi żadnej odpowiedzialności za ewentualne obrażenia lub uszkodzenia produktu wynikłe z następujących przyczyn:

- Nieprawidłowy montaż lub podłączenie, w tym zbyt wysokie napięcie
- Niewłaściwa konserwacja lub użycie innych części zamiennych niż oryginalne części zamienne dostarczone przez producenta
- Wprowadzanie zmian w produkcie bez wyraźnej zgody producenta
- Użytkowanie w celach innych niż opisane w niniejszej instrukcji obsługi

Firma Dometic zastrzega sobie prawo do zmiany wyglądu i specyfikacji produktu.

## 5 Objaśnienie symboli na urządzeniu



Ostrzeżenie! Materiał o niskiej prędkości spalania.



Przeczytać instrukcję obsługi.



Przeczytać instrukcję serwisową.

## 6 Ograniczenia techniczne i warunki zastosowania

Klimatyzator dachowy przeznaczony jest do pojazdów z dachem o grubości w zakresie 25 mm ... 60 mm. Działanie klimatyzatora dachowego jest gwarantowane w temperaturach w zakresie - 2 °C ... 52 °C. Klimatyzator dachowy przeznaczony jest do montażu pod kątem maks. ± 10 ° w stosunku do płaszczyzny poziomej. Wydajność klimatyzatora dachowego może ulec pogorszeniu, jeśli jest on narażony na silne drgania, na przykład spowodowane złymi warunkami na drodze.

## 7 Opis techniczny

Klimatyzator dachowy FJX4233M dostarcza do wnętrza pojazdu pozbawione kurzu i zanieczyszczeń chłodne powietrze, które może być też osuszane.

Klimatyzator dachowy FreshJet FJX4233EEH/FJX4333E(EH)/FJX7333IHP/FJX7337IHP/FJX7457IHP dostarcza do wnętrza pojazdu pozbawione kurzu i zanieczyszczeń chłodne lub ciepłe powietrze, które może być też osuszane.

Klimatyzator dachowy może obniżyć temperaturę wewnątrz pojazdu do określonego poziomu, który zależy od typu pojazdu, temperatury otoczenia i wydajności chłodniczej klimatyzatora dachowego. Jeżeli temperatura powietrza na zewnątrz wynosi mniej niż 16 °C, klimatyzator dachowy nie umożliwia jego dalszego chłodzenia.

Do obsługi klimatyzatora dachowego służą następujące elementy:

- Panel sterowania

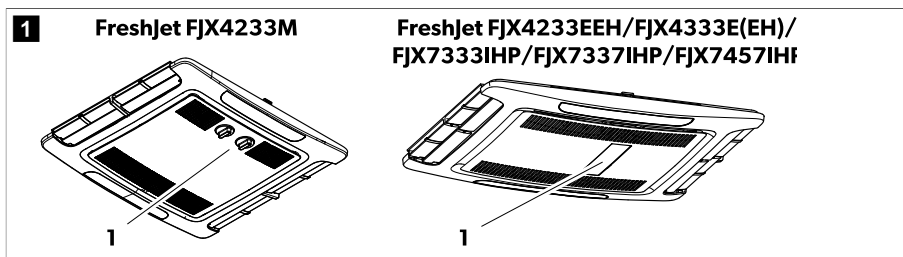

- Pilot (tylko FJX4233EEH/FJX4333E(EH)/FJX7333IHP/FJX7337IHP/FJX7457IHP)

## 7.1 Lista modeli

W poniższej tabeli zestawiono funkcje poszczególnych modeli:

● Funkcja dostępna

○ Możliwość rozszerzenia o funkcję

	FJX4233M	FJX4233EEH	FJX4333EEH	FJX4333E	FJX7333IHP	FJX7337IHP	FJX7457IHP
automatyczne		●	●	●	●	●	●
Chłodzenie	●	●	●	●	●	●	●
Ogrzewanie		●	●	○	●	●	●
Wentylacja	●	●	●	●	●	●	●
Osuszanie		●	●	●	●	●	●
Oczyszczacz powietrza	○	●	●	○	●	●	●
Lampa ADB		●	●	○	●	●	●
Zewnętrzne oświetlenie					●	●	●
Timer		●	●	●	●	●	●
Sen		●	●	●	●	●	●
Soft Start			●	○	●	●	●

## 7.2 Panel sterowania FreshJet FJX4233M

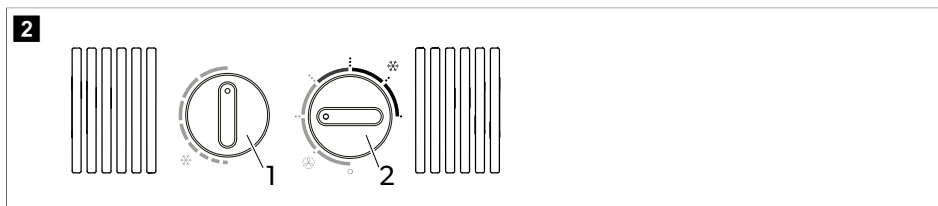

Pokrętko	Opis
	Pozwala wybrać temperaturę. Obrócenie w kierunku ruchu wskazówek zegara powoduje ustawienie intensywniejszego chłodzenia.
	Umożliwia włączenie lub wyłączenie klimatyzatora dachowego oraz wybór intensywności obiegu powietrza w trybie wentylacji (🌀) lub intensywności chłodzenia w trybie chłodzenia (❄️).

### 7.3 Panel sterowania FreshJet FJX4233EEH/FJX4333E(EH)/FJX7333IHP/ FJX7337IHP/FJX7457IHP

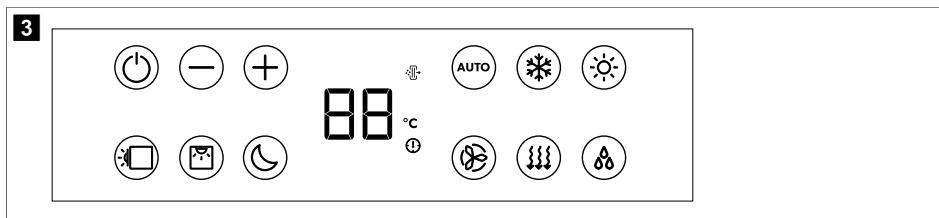

Symbol	Opis
	Przełącza klimatyzator dachowy w tryb czuwania.
	Zwiększa aktualnie wyświetlaną wartość.
	Zmniejsza aktualnie wyświetlaną wartość.
	Jednoczesne naciśnięcie obydwu przycisków powoduje sparowanie z urządzeniem Bluetooth/WLAN.
	Włącza lub wyłącza oświetlenie w jednostce dachowej.
	Włącza lub wyłącza oświetlenie w skrzynce rozdzielczej powietrza.
	Aktywacja funkcji uśpienia (Dodatkowe funkcje (tylko FJX4233EEH/FJX4333E(EH)/FJX7333IHP/FJX7337IHP/FJX7457IHP) na stronie 339).
	Wyświetla ustawioną temperaturę i wskazuje poziom wentylatora podczas regulacji wentylatora.
	Informuje, że tryb oczyszczania powietrza jest włączony.
	Informuje, że temperatura wyświetlana jest w stopniach Celsjusza.
	Wskazuje ustawienie regulatora czasowego.
	Włącza/wyłącza tryb automatyczny (Tryby klimatyzacji (tylko FJX4233EEH/FJX4333E(EH)/FJX7333IHP/FJX7337IHP/FJX7457IHP) na stronie 339).
	Włącza/wyłącza tryb chłodzenia (Tryby klimatyzacji (tylko FJX4233EEH/FJX4333E(EH)/FJX7333IHP/FJX7337IHP/FJX7457IHP) na stronie 339).
	Włącza/wyłącza tryb ogrzewania (Tryby klimatyzacji (tylko FJX4233EEH/FJX4333E(EH)/FJX7333IHP/FJX7337IHP/FJX7457IHP) na stronie 339).
	Ustawia prędkość wentylatora na niską, średnią, wysoką, turbo lub automatyczną (ustawienia te widoczne są na wyświetlaczu skrzynki rozdzielczej powietrza przez chwilę po ich zmianie – odpowiednio jako 1, 2, 3, 4 lub AA).



















Symbol	Opis
	Włącza/wyłącza tryb wentylacji (Tryby klimatyzacji (tylko FJX4233EEH/FJX4333E(EH)/FJX7333IHP/FJX7337IHP/FJX7457IHP) na stronie 339). Zapewnia cyrkulację powietrza bez ogrzewania ani chłodzenia.
	Włącza/wyłącza tryb osuszania (Tryby klimatyzacji (tylko FJX4233EEH/FJX4333E(EH)/FJX7333IHP/FJX7337IHP/FJX7457IHP) na stronie 339).

## 7.4 Pilot do FreshJet FJX4233EEH/FJX4333E(EH)/FJX7333IHP/FJX7337IHP/FJX7457IHP





Elementy obsługowe i wskaźniki rys. **4** na stronie 337:

Przycisk	Opis
—	<p><b>Wyświetlacz</b></p> <p>Wyświetla następującą wartość:</p> <ul style="list-style-type: none"> <li>• Godzina</li> <li>• Wybrana temperatura wewnętrzna (wartość docelowa) w °C</li> <li>• Rzeczywista temperatura pomieszczenia</li> <li>• Tryb klimatyzacyjny</li> <li>• Prędkość wentylatora</li> <li>• Symbole aktywnych funkcji dodatkowych</li> <li>• Status baterii</li> </ul>
	Przełącza klimatyzator dachowy do trybu czuwania.
	Zwiększa aktualnie wyświetlaną wartość.
	Zmniejsza aktualnie wyświetlaną wartość.
	Wybiera prędkość wentylatora (Ręczne wybieranie prędkości wentylatora na stronie 343).
	Wybiera tryb klimatyzacji (Tryby klimatyzacji (tylko FjX4233EEH/FjX4333E(EH)/FjX7333IHP/FjX7337IHP/FjX7457IHP) na stronie 339). Wyświetlony zostaje odpowiedni symbol.
	Aktywacja funkcji uśpienia (Dodatkowe funkcje (tylko FjX4233EEH/FjX4333E(EH)/FjX7333IHP/FjX7337IHP/FjX7457IHP) na stronie 339). Wyświetlony zostaje symbol  .
	Potwierdza i zapisuje ustawienia.
	Ustawia timer i zegar.
	Włącza lub wyłącza oświetlenie w skrzynce rozdzielczej powietrza.
	<p>Jednokrotne naciśnięcie powoduje wyświetlenie aktualnej temperatury wewnętrznej. Wyświetlony zostaje symbol .</p> <p>Dwukrotne naciśnięcie powoduje wyświetlenie ustawionej temperatury.</p>
	<p>Aktywacja funkcji I feel. Wyświetlony zostaje symbol .</p> <p>Funkcja I feel co 10 min dostosowuje temperaturę docelową do rzeczywistej temperatury zmierzonej przez pilota.</p>
	Włącza lub wyłącza oświetlenie w jednostce dachowej.
	Informuje, że baterie pilota są wyczerpane. Należy wówczas wymienić baterie (Wymiana baterii w pilocie na stronie 346).
	Informuje, że pilot przesyła obecnie ustawienia do klimatyzatora dachowego.

## 7.5 Tryby klimatyzacji (tylko FJX4233M)

W klimatyzatorze dachowym dostępne są następujące tryby klimatyzacji:

Tryb klimatyzacyjny	Wyświetlany symbol	Opis
Chłodzenie		Użytkownik ustawia temperaturę i prędkość wentylatora, a klimatyzator dachowy chłodzi wnętrze do tej temperatury.
Wentylacja		Użytkownik ustawia prędkość wentylatora, a klimatyzator dachowy zapewnia wyłącznie obieg powietrza, bez ogrzewania ani chłodzenia.





## 7.6 Tryby klimatyzacji (tylko FJX4233EEH/FJX4333E(EH)/FJX7333IHP/FJX7337IHP/FJX7457IHP)

W klimatyzatorze dachowym dostępne są następujące tryby klimatyzacji:

Tryb klimatyzacyjny	Wyświetlany symbol	Opis
automatyczne	<b>A</b>	Użytkownik ustawia temperaturę, a klimatyzator dachowy doprowadza do niej wnętrze pojazdu poprzez ogrzewanie lub chłodzenie powietrza i sterowanie wymaganą prędkością wentylatora.
Chłodzenie		Użytkownik ustawia temperaturę i prędkość wentylatora, a klimatyzator dachowy chłodzi wnętrze do tej temperatury.
Ogrzewanie		<b>Za wyjątkiem FJX4333E:</b> Użytkownik ustawia temperaturę i prędkość wentylatora, a klimatyzator dachowy ogrzewa wnętrze do tej temperatury. Wentylator uruchamia się po 2 min (z niską prędkością), a następnie po około 5 min przechodzi do ustawionej prędkości (gdy parownik osiągnie wymaganą temperaturę).
Wentylacja		Użytkownik ustawia prędkość wentylatora, a klimatyzator dachowy zapewnia wyłącznie obieg powietrza, bez ogrzewania ani chłodzenia.
Osuszanie powietrza		Klimatyzator dachowy usuwa wilgoć z powietrza, nie ogrzewając ani nie chłodząc wnętrza, co powoduje obniżenie względnej wilgotności powietrza.
Oczyszczacz powietrza		<b>Za wyjątkiem FJX4333E:</b> Klimatyzator dachowy jonizuje powietrze, usuwając z niego kurz i cząstki stałe, w tym wirusy i bakterie.

## 7.7 Dodatkowe funkcje (tylko FJX4233EEH/FJX4333E(EH)/FJX7333IHP/FJX7337IHP/FJX7457IHP)

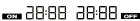
W klimatyzatorze dachowym dostępne są następujące dodatkowe funkcje:

Funkcja dodatkowa	Komunikat wyświetlany na wyświetlaczu	Opis
Timer		Klimatyzator dachowy włącza się o ustawionej godzinie.
		Klimatyzator dachowy wyłącza się o ustawionej godzinie.
		Klimatyzator dachowy włącza i wyłącza się o ustawionych godzinach.
Sen		Funkcja snu ogranicza prędkość wentylatora i sprężarki, aby obniżyć poziom hałasu na czas snu.
I Feel		Pilot mierzy temperaturę wewnętrzną i co 10 min przekazuje zmierzoną wartość do klimatyzatora dachowego. Klimatyzator dachowy dostosowuje docelową wartość do tego pomiaru.
Soft Start		<b>Za wyjątkiem FJX4233EEH:</b> Funkcja łagodnego rozruchu ogranicza prąd szczytowy generowany przez sprężarkę. Jeżeli do zasilania wykorzystywany jest generator, zapobiega to jego przeciążeniu.

## 8 Przed pierwszym użyciem

### Kontrole przed uruchomieniem

Przed włączeniem klimatyzatora dachowego należy uwzględnić następujące warunki:

1. Sprawdzić, czy napięcie i częstotliwość zasilania są zgodne z wartościami podanymi w sekcji Dane techniczne na stronie 354.
2. Upewnić się, czy otwory wlotu powietrza i dysze nawiewu nie są zatkane ani zasłonięte. Wszystkie kratki wentylacyjne muszą być zawsze wolne, aby klimatyzator dachowy mógł pracować z maksymalną wydajnością.

### Przygotować pilota (tylko FreshJet FJX4233EEH/FJX4333E(EH)/FJX7333IHP/FJX7337IHP/FJX7457IHP)

3. Włóż baterie (Wymiana baterii w pilocie na stronie 346).

### Ustawianie godziny (tylko FreshJet FJX4233EEH/FJX4333E(EH)/FJX7333IHP/FJX7337IHP/FJX7457IHP)

4. Ustawić aktualną godzinę (Ustawianie aktualnej godziny na stronie 343).

## 9 Eksploatacja

### 9.1 Wskazówki dotyczące optymalnego wykorzystania

Poniższe wskazówki pozwalają zoptymalizować działanie klimatyzatora dachowego:

- Należy poprawić izolację cieplną pojazdu poprzez uszczelnienie szczelin i powieszenie na oknach rolet lub zasłon odbijających promienie słoneczne.
- Wybrać odpowiednią temperaturę i poziom nawiewu.
- Odpowiednio ustawić dysze powietrza.

- Uważać, aby nie zakrywać dysz nawiewu ani wlotów powietrza tkaninami, papierem ani innymi przedmiotami.
- **Dotyczy tylko FreshJet FJX4233EEH/FJX4333E(EH)/FJX7333IHP/FJX7337IHP/FJX7457IHP:** Jeżeli pojazd był przez długi czas narażony na bezpośrednie działanie promieni słonecznych: Przez jakiś czas pozostawić klimatyzator dachowy pracujący w trybie wentylacji (☼) przy otwartych oknach przed przełączeniem go w tryb chłodzenia (❄️).
- **Dotyczy tylko FreshJet FJX4233EEH/FJX4333E(EH)/FJX7333IHP/FJX7337IHP/FJX7457IHP:** W trybie chłodzenia (❄️) należy w miarę możliwości unikać otwierania drzwi i okien.

## 9.2 Podstawowe wskazówki dotyczące obsługi

Klimatyzator dachowy FreshJet FJX4233M ma trzy tryby pracy:

Tryb pracy	Opis
Wyłączony	Klimatyzator zostanie wyłączony.
Chłodzenie	Klimatyzator dachowy chłodzi wewnątrz.
Wentylacja	Klimatyzator dachowy zapewnia obieg powietrza bez chłodzenia.

Klimatyzatory dachowe FJX4233EEH/FJX4333E(EH)/FJX7333IHP/FJX7337IHP/FJX7457IHP mają dwa tryby pracy:

Tryb pracy	Opis
Tryb czuwania	Klimatyzator dachowy jest gotowy do pracy i można go włączyć za pomocą pilota. Dostępne jest oświetlenie. Pilot również znajduje się w trybie czuwania, ale można go włączyć niezależnie od klimatyzatora dachowego.
Włączony	Klimatyzator dachowy klimatyzuje powietrze we wnętrzu.

## 9.3 Dometic FJX4233M

Informacje zawarte w tym rozdziale dotyczą wyłącznie klimatyzatorów dachowych FJX4233M.

### 9.3.1 Włączanie i wyłączanie klimatyzatora dachowego

W klimatyzatorze dachowym dostępne są dwa tryby klimatyzacji:

- Tryb (☼) wentylacji
- Tryb chłodzenia (❄️)



**Wskazówka** Odczekać co najmniej 30 s przed przełączeniem z trybu wentylacji na tryb chłodzenia lub odwrotnie. W innym wypadku prąd przełączania może spowodować zadziałanie bezpiecznika.

Każdy tryb ma trzy ustawienia:

- ..: niska
- ...: średnie

- ...: wysoka

>

W celu włączenia urządzenia ustawić pokrętko  w położeniu trybu wentylacji () lub chłodzenia () i wybrać żądane ustawienie.

- ✓ Klimatyzator dachowy włączy się i będzie pracować z wartościami, które ustawione były przed jego wyłączeniem.

>

W celu wyłączenia urządzenia, obrócić pokrętko  do położenia 0.

### 9.3.2 Ustawianie temperatury

>

Ustawić pokrętko  w żądanym położeniu. Obrócenie pokrętkła w kierunku ruchu wskazówek zegara powoduje ustawienie niższej temperatury.

- ✓ Temperatura została ustawiona w klimatyzatorze dachowym.

## 9.4 FreshJet FJX4233EEH/FJX4333E(EH)/FJX7333IHP/FJX7337IHP/FJX7457IHP

Informacje zawarte w tym rozdziale dotyczą wyłącznie klimatyzatorów dachowych FreshJet FJX4233EEH/FJX4333E(EH)/FJX7333IHP/FJX7337IHP/FJX7457IHP.

### 9.4.1 Pilot



Podczas korzystania z pilota należy mieć na uwadze poniższe informacje:

- Pilota należy kierować w stronę odbiornika podczerwieni na panelu sterowania.
- Naciśnięcie przycisku powoduje bezpośrednie przesłanie ustawień i wartości do klimatyzatora dachowego.
- Klimatyzator dachowy potwierdza odebranie danych krótkim sygnałem dźwiękowym.
- Aby szybciej zwiększać lub zmniejszać wartości, należy nacisnąć i przytrzymać przycisk + lub –.
- W trybie czuwania również wyświetlacz pilota pozostaje nieaktywny. Pilota przełączać w tryb czuwania niezależnie od klimatyzatora dachowego.
- > W celu przełączenia tylko samego pilota w tryb czuwania lub wybudzenia go z niego, należy nacisnąć przycisk , nie kierując pilota w stronę odbiornika podczerwieni na panelu sterowania.

### 9.4.2 Włączanie klimatyzatora dachowego i przełączanie go w tryb czuwania



**Wskazówka** Po włączeniu klimatyzator dachowy pracuje z wartościami, które ustawione były przed jego przełączeniem w tryb czuwania. Klimatyzator dachowy można wyłączyć tylko przez odcięcie zasilania.





- > Nacisnąć przycisk  na pilocie lub przycisk  na panelu sterowania w celu włączenia klimatyzatora dachowego lub przełączenia go w tryb czuwania.



### 9.4.3 Wybór trybu klimatyzacji

- > Wybrać żądany tryb klimatyzacji, używając przycisku MODE (Tryby klimatyzacji (tylko FJX4233EEH/FJX4333E(EH)/FJX7333IHP/FJX7337IHP/FJX7457IHP) na stronie 339).
- ✓ Klimatyzator dachowy potwierdzi odebranie wartości ustawienia krótkim sygnałem dźwiękowym. Klimatyzator przełącza się do wybranego trybu klimatyzacji.

### 9.4.4 Ręczne wybieranie prędkości wentylatora

We wszystkich trybach, oprócz trybu automatycznego (A) i osuszania (☉), prędkość wentylatora można regulować ręcznie.

Komunikat wyświetlany na wyświetlaczu	Opis
	Niska prędkość wentylatora
	Średnia prędkość wentylatora
	Wysoka prędkość wentylatora.
	Prędkość „turbo” wentylatora.
	Tryb automatyczny (prędkość wentylatora dobierana jest w zależności od temperatury otoczenia).

- > Nacisnąć przycisk  na pilocie lub przycisk  na panelu sterowania w celu wybrania żądanej prędkości wentylatora.
- ✓ Klimatyzator dachowy potwierdzi odebranie wartości ustawienia krótkim sygnałem dźwiękowym.  
Nowa prędkość wentylatora została ustawiona.

### 9.4.5 Ustawianie temperatury

W trybach automatycznym (A), chłodzenia (❄️), ogrzewania (☀️) i osuszania (☉) można ustawić temperaturę w zakresie pomiędzy 16 °C a 31 °C.

- > Ustawić żądaną temperaturę za pomocą przycisków + lub – na pilocie.
- ✓ Klimatyzator dachowy potwierdza odebranie wartości ustawienia wysokim tonem. Temperatura została ustawiona w klimatyzatorze dachowym.

### 9.4.6 Ustawianie aktualnej godziny

Aby zaprogramować timer, na pilocie musi być ustawiony aktualny czas. Godzina wskazywana jest na wyświetlaczu pilota.

1. Nacisnąć i przytrzymać przycisk , aby przejść do trybu ustawiania godziny.
- ✓ Godzina pulsuje na wyświetlaczu pilota.
2. Ustawić aktualną godzinę za pomocą przycisku + lub –. Aby móc szybciej zwiększać lub zmniejszać ustawienie czasu, nacisnąć i przytrzymać przycisk + lub – na dłużej niż 2 s.
3. Należy przycisnąć przycisk SET, aby potwierdzić godzinę.















### 9.4.7 Ustawianie timera

Za pomocą funkcji timera można ustawić wymagany czas działania klimatyzacji. Można określić godzinę włączenia, godzinę przechodzenia w tryb czuwania lub obydwie te wartości.

Funkcję timera ustawia się za pomocą pilota.



**Wskazówka** Jeśli podczas programowania timera przez 15 s nie zostanie naciśnięty żaden przycisk na pilocie, pilot powróci do trybu wyjściowego.

- > **Timer włączania** ustawia się w następujący sposób:
  - a) Wybrać żądany tryb klimatyzacji oraz wszystkie wymagane wartości (np. temperaturę).
  - b) W razie potrzeby przełączyć klimatyzator dachowy w tryb czuwania.  
Timer włączania można ustawić wyłącznie wtedy, gdy klimatyzator dachowy znajduje się w **trybie czuwania**.
  - c) Jednokrotnie naciśnięć przycisk .
  - ✓ Na wyświetlaczu pilota będzie migać symbol  .
  - d) Za pomocą przycisków + lub – ustawić godzinę, o której klimatyzator dachowy ma się włączyć.
  - e) Naciśnięć przycisk  .  
Timer włączania został ustawiony. Klimatyzator dachowy włączy się w wybranym trybie klimatyzacji o ustawionej godzinie.
- > **Timer przechodzenia w tryb czuwania** ustawia się w następujący sposób:
  - a) W razie potrzeby włączyć klimatyzator dachowy.  
Timer przechodzenia w tryb czuwania można ustawić wyłącznie wtedy, gdy klimatyzator dachowy jest **włączony**.
  - b) Dwukrotnie naciśnięć przycisk .
  - ✓ Na wyświetlaczu pilota będzie migać symbol  .
  - c) Za pomocą przycisków + lub – ustawić godzinę, o której klimatyzator dachowy ma przejść w tryb czuwania.
  - d) Naciśnięć przycisk  .  
Timer przechodzenia w tryb czuwania został ustawiony. Klimatyzator dachowy przejdzie o ustawionej godzinie w tryb czuwania.
- > **Timer włączania i timer przechodzenia w tryb czuwania** ustawia się w następujący sposób:
  - a) Wybrać żądany tryb klimatyzacji oraz wszystkie wymagane wartości (np. temperaturę).
  - b) Trzykrotnie naciśnięć przycisk .
  - ✓ Na wyświetlaczu pilota pojawi się symbol   . Symbol ON będzie migać.
  - c) Za pomocą przycisków + lub – ustawić godzinę, o której klimatyzator dachowy ma się włączyć.
  - d) Naciśnięć przycisk .
  - ✓ Symbol **OFF** będzie migać.
  - e) Za pomocą przycisków + lub – ustawić godzinę, o której klimatyzator dachowy ma przejść w tryb czuwania.
  - f) Naciśnięć przycisk  .  
✓ Timer włączania i timer przechodzenia w tryb czuwania zostały ustawione. Klimatyzator dachowy będzie pracować w ustawionym przedziale czasu.
  - > Aby **anulować** ustawiony timer, jednokrotnie naciśnięć przycisk .
  - ✓ Symbol   zniknie. Ustawione wartości zostaną usunięte.







### 9.4.8 Ustawianie funkcji snu

Funkcja snu jest dostępna tylko w trybie chłodzenia () lub ogrzewania ().

Gdy funkcja snu jest aktywna, prędkość wentylatora jest ograniczana, aby obniżyć poziom hałasu na czas snu.



**Tylko FJX7333IHP/FJX7337IHP/FJX7457IHP:** Funkcja snu dodatkowo ogranicza prędkość sprężarki.

- > Aby aktywować funkcję snu, należy postępować w następujący sposób:
  - a) Ustawić żądaną temperaturę (Ustawianie temperatury na stronie 343).
  - b) Nacisnąć przycisk  na pilocie lub przycisk  na panelu sterowania.
- ✓ Na wyświetlaczu pilota pojawi się symbol . Funkcja snu jest aktywna.
  - > Aby dezaktywować funkcję snu, nacisnąć przycisk  lub  na pilocie albo też przycisk  na panelu sterowania.
- ✓ Symbol  zniknie z wyświetlacza pilota. Funkcja snu zostanie dezaktywowana.

### 9.4.9 Aktywacja funkcji I feel

Gdy funkcja ta jest aktywna, pilot mierzy temperaturę wewnętrzną i co 10 minut przekazuje zmierzoną wartość do klimatyzatora dachowego. Klimatyzator dachowy dostosowuje docelową wartość do tego pomiaru. Funkcja I feel jest aktywna tylko wtedy, gdy temperatura wynosi pomiędzy +18°C a +29°C.

Pilot nie powinien znajdować się w części pomieszczenia, która jest znacznie cieplejsza lub zimniejsza niż średnia temperatura pomieszczenia. Nie należy go np. pozostawiać na słońcu ani przed klimatyzatorem dachowym.

Funkcja zostaje dezaktywowana, jeżeli temperatura wzrośnie powyżej +29°C lub spadnie poniżej +18°C. Na wyświetlaczu trzy razy zamiga symbol , a następnie zgaśnie.

1. Nacisnąć przycisk.
- ✓ Funkcja I feel jest aktywowana.

Na wyświetlaczu pojawi się symbol .

2. Położyć pilota tak, aby był on skierowany w stronę odbiornika podczerwieni na panelu sterowania. W przeciwnym razie nie będzie możliwości przesyłania wartości do klimatyzatora dachowego.







### 9.4.10 Obsługa oświetlenia



**OSTRZEŻENIE! Ryzyko obrażeń** Prawo zakazuje używania zewnętrznego oświetlenia podczas prowadzenia pojazdu.

Przycisk  na pilocie jest aktywny, nawet jeśli pilot jest wyłączony.

**Dotyczy tylko FreshJet FJX4233EEH/FJX4333E(EH)/FJX7333IHP/FJX7337IHP/FJX7457IHP:**

- > Aby włączyć lub wyłączyć wewnętrzne oświetlenie, nacisnąć przycisk  na pilocie lub na panelu sterowania.
- ✓ Po **włączeniu** wewnętrznego oświetlenia na wyświetlaczu pilota jednokrotnie miga symbol .
- > W celu przyciemnienia oświetlenia wewnętrznego należy:
  - a) Nacisnąć przycisk  na pilocie lub na panelu sterowania i przytrzymać go przez 3 s.
  - b) Podczas trzymania wciśniętego przycisku  na pilocie: Naciskać przycisk  w celu przyciemnienia wewnętrznego oświetlenia w zakresie pomiędzy 50 % a 100 %.
  - c) Podczas trzymania wciśniętego przycisku  na panelu sterowania: Jasność wewnętrznego oświetlenia jest cyklicznie przełączana w zakresie pomiędzy 50 % a 100 %. Zwolnić przycisk  po osiągnięciu żądanej jasności.

**Dotyczy tylko FreshJet FJX7333IHP/FJX7337IHP/FJX7457IHP:**

- > Aby włączyć lub wyłączyć zewnętrzne oświetlenie, nacisnąć przycisk  na panelu sterowania.

### 9.4.11 Wymiana baterii w pilocie



**Wskazówka** Wyświetlacz pilota może wciąż pozostać jasny, nawet jeśli baterie są bliskie wyczerpania. Baterie należy wymienić, jeżeli pilot wskazuje ich niski poziom naładowania.

- > Wymienić baterie w zilustrowany sposób.

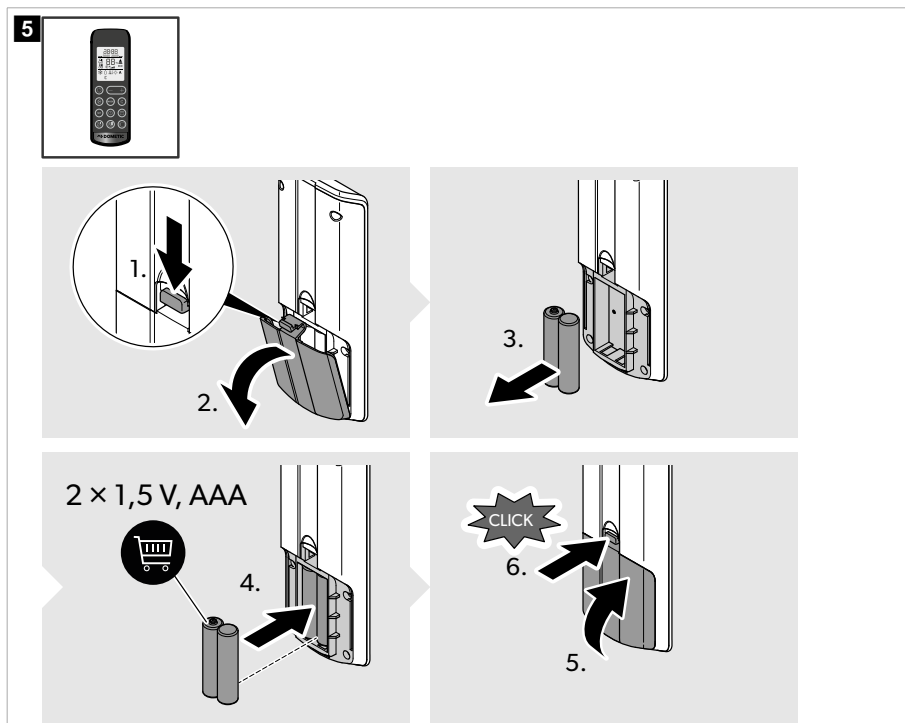

- ✓ Na wyświetlaczu na 5 s pojawią się wszystkie symbole.



Chroń środowisko naturalne! Akumulatorów i baterii nie należy wrzucać do pojemników na odpady komunalne. Uszkodzone akumulatory lub zużyte baterie należy przekazać do punktu sprzedaży lub odpowiedniego punktu zbiórki.

### 9.5 Regulacja nawiewu w pojeździe

Przepływ powietrza można regulować wzdłuż sufitu lub w kierunku podłogi.

- > Obrócić łopatkę dysz nawiewu w żądanym kierunku. Każdą z dysz można regulować niezależnie.

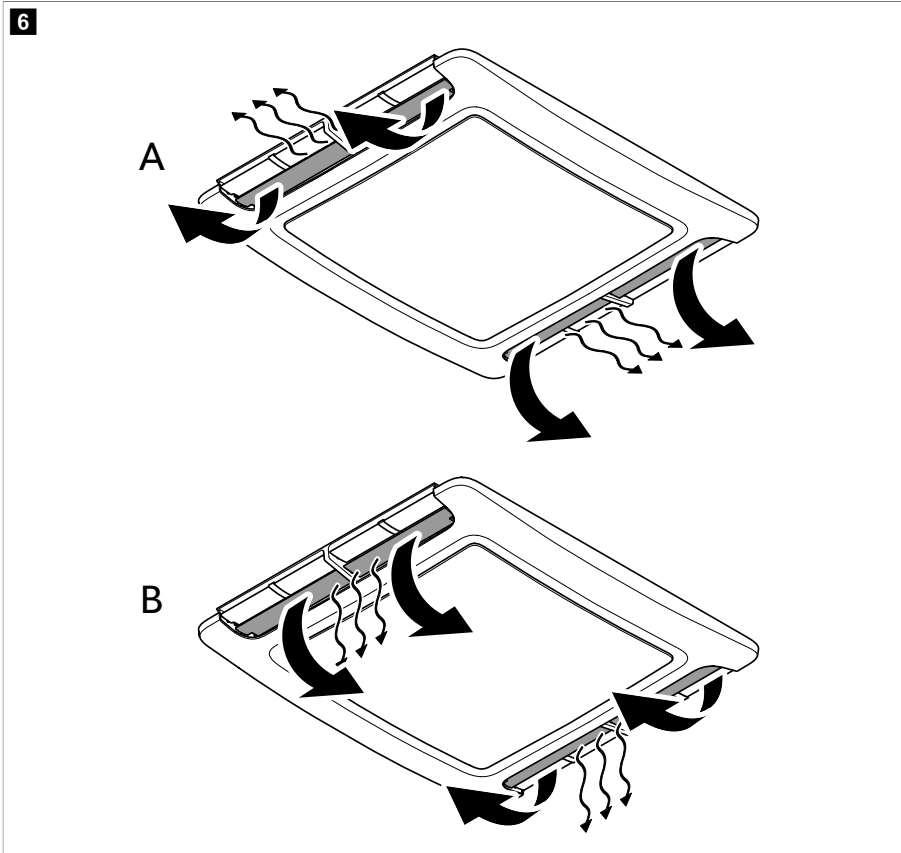

## 10 Czyszczenie klimatyzatora dachowego



### UWAGA! Ryzyko uszkodzenia

- Do przyspieszania procesu odszraniania i czyszczenia nie należy używać żadnych innych środków oprócz tych, które zaleca producent.
- Klimatyzatora dachowego nie należy czyścić za pomocą urządzenia wysokociśnieniowego. Wciekająca woda może uszkodzić klimatyzator.
- Do czyszczenia nie należy używać ostrych ani twardych przedmiotów ani środków czyszczących – mogą one uszkodzić klimatyzator dachowy.
- Nie stosować benzyny, oleju napędowego ani rozpuszczalników.

1. Regularnie usuwać liście i inne zanieczyszczenia z wlotu powietrza i z kratki wentylacyjnych klimatyzatora dachowego. Należy przy tym uważać, aby nie uszkodzić kratki wentylacyjnych.

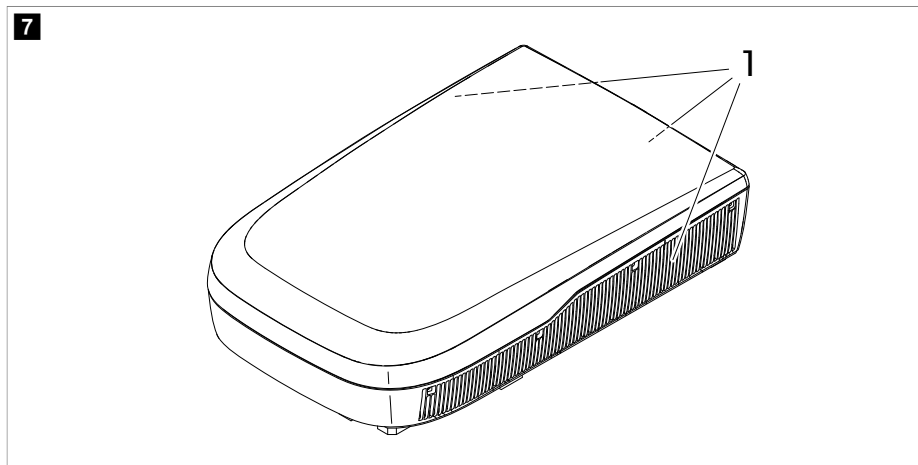

2. Od czasu do czasu czyścić wilgotną ściereczką obudowę jednostki dachowej klimatyzatora i skrzynki rozdzielczej powietrza. Stosować jedynie wodę z łagodnym środkiem czyszczącym.
3. **Dotyczy tylko FreshJet FJX4233EEH/FJX4333E(EH)/FJX7333IHP/FJX7337IHP/FJX7457IHP:** Od czasu do czasu czyścić pilota lekko zwilżoną ściereczką. Wyświetlacz czyścić chusteczką do okularów.
4. **Dotyczy tylko FreshJet FJX4233EEH/FJX4333E(EH)/FJX7333IHP/FJX7337IHP/FJX7457IHP:** Od czasu do czasu czyścić wyświetlacz skrzynki rozdzielacza powietrza łagodnym roztworem ciepłej wody z mydłem. Ekran wyświetlacza jest wykonany z akrylu i niektóre środki chemiczne powszechnie stosowane w gospodarstwie domowym, takie jak chemiczne środki czyszczące, środki do czyszczenia okien, alkohol, niektóre tensydy, rozpuszczalniki organiczne i środki zmiękczające, mogą go uszkodzić.

## 11 Konserwacja

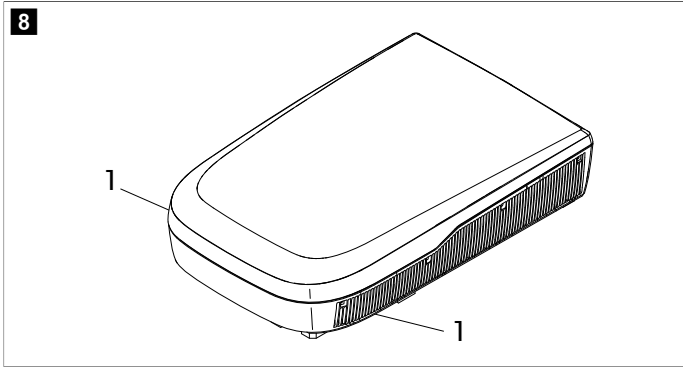
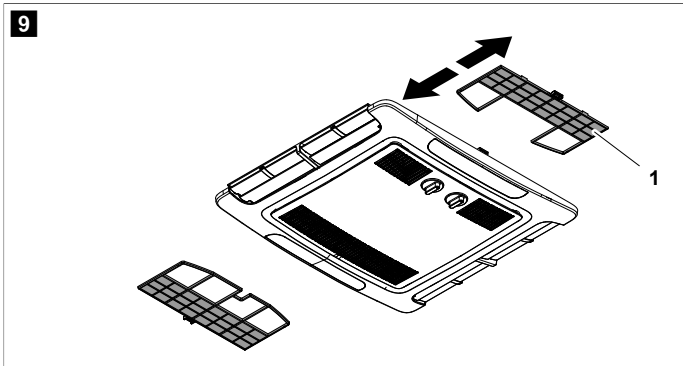

**OSTRZEŻENIE! Ryzyko obrażeń** Wszelkie prace konserwacyjne wykraczające poza opisany tu zakres mogą być wykonywane wyłącznie przez wykwalifikowany personel świadomy zagrożeń związanych z pracą z czynnikiem chłodniczym i układami klimatyzacji oraz znający odpowiednie przepisy.

Interwał	Kontrola/Konserwacja
Regularnie	<p data-bbox="333 188 992 233">Sprawdzić, czy kanały odprowadzania skroplin (1) po bokach klimatyzatora dachowego są czyste a skropliny mogą swobodnie odpływać.</p> 
Regularnie (FreshJet FJX4233M)	<p data-bbox="333 643 598 663">Oczyszczyć filtr jednostki nawiewowej.</p>  <ol data-bbox="348 1062 874 1126" style="list-style-type: none"><li>1. Wyjąć filtr (1).</li><li>2. Oczyszczyć filtr (1) roztworem detergentu i pozostawić do wyschnięcia.</li><li>3. Z powrotem umieścić suchy filtr (1).</li></ol>

Interwał	Kontrola/Konserwacja
Regularnie (FreshJet FJX4233EEH/FJX4333E(E-H)/FJX7333IHP/FJX7337IHP/FJX7457IHP)	<ul style="list-style-type: none"> <li>Oczyścić filtr jednostki nawiewowej.</li> </ul> <div data-bbox="367 225 1016 528" style="border: 1px solid black; padding: 10px; margin: 10px 0;"> <p><b>10</b></p> </div> <ol style="list-style-type: none"> <li>Włożyć płaski wkrętak lub nóż w uchwyt (1), aby nieznacznie wysunąć filtry (2).</li> <li>Wymontować filtry ręcznie.</li> <li>Oczyścić filtry roztworem środka czyszczącego i pozostawić je do wyschnięcia.</li> <li>Z powrotem wsunąć suche filtry, rys. 10 na stronie 350</li> </ol> <ul style="list-style-type: none"> <li>Zlecić specjalistycznej firmie konserwację wymiennika ciepła klimatyzatora dachowego.</li> </ul>
Raz w roku	<ul style="list-style-type: none"> <li>Sprawdzić uszczelnienia pomiędzy klimatyzatorem dachowym a dachem pojazdu pod kątem pęknięć i innych uszkodzeń.</li> <li>Sprawdzić, czy śruby mocujące są dokręcone właściwym momentem (2.5 Nm <math>\pm</math> 0.3 Nm), i w razie potrzeby dokręcić je.</li> </ul>

## 12 Usuwanie usterek

Usterka	Możliwa przyczyna	Proponowane rozwiązanie
Chłodzenie jest niewystarczające	Klimatyzator dachowy nie jest ustawiony na chłodzenie.	Należy ustawić klimatyzator na chłodzenie.
	Temperatura otoczenia przekracza 52 °C.	Klimatyzator dachowy jest przeznaczony do pracy przy temperaturze otoczenia nieprzekraczającej 52 °C.
	Ustawiona temperatura jest wyższa niż temperatura pomieszczenia.	Należy wybrać niższą temperaturę.
	Temperatura otoczenia jest niższa niż 16 °C.	Klimatyzator dachowy jest przeznaczony do chłodzenia tylko przy temperaturach otoczenia powyżej 16 °C.
	Jeden z czujników temperatury jest uszkodzony.	Skontaktować się z autoryzowanym centrum serwisowym lub firmą Dometic.
	Dmuchawa parownika jest uszkodzona.	Skontaktować się z autoryzowanym centrum serwisowym lub firmą Dometic.

Usterka	Możliwa przyczyna	Proponowane rozwiązanie
	Dmuchawa kondensatora jest uszkodzona.	Skontaktować się z autoryzowanym centrum serwisowym lub firmą Dometic.
<b>Dotyczy tylko FreshJet FJX4233EEH/FJX4333E(E-H)/FJX7333IHP/FJX7337IHP/FJX7457IHP:</b> Ogrzewanie nie jest wystarczające	Klimatyzator dachowy nie jest ustawiony na ogrzewanie.	Należy ustawić klimatyzator na ogrzewanie.
	Temperatura otoczenia jest niższa niż $-2^{\circ}\text{C}$ .	Klimatyzator dachowy jest przeznaczony do pracy tylko przy temperaturach otoczenia powyżej $-2^{\circ}\text{C}$ .
	Ustawiona temperatura jest niższa niż temperatura pomieszczenia.	Należy wybrać wyższą temperaturę.
	Jeden z czujników temperatury jest uszkodzony.	Skontaktować się z autoryzowanym centrum serwisowym lub firmą Dometic.
	Dmuchawa parownika jest uszkodzona.	Skontaktować się z autoryzowanym centrum serwisowym lub firmą Dometic.
Słaby strumień powietrza	Wloty powietrza są zatkane lub zasłonięte.	Co jakiś czas usuwać liście i inne zabrudzenia z kratki wentylacyjnych klimatyzatora dachowego.
	Dmuchawa jest uszkodzona.	Skontaktować się z autoryzowanym centrum serwisowym lub firmą Dometic.
Pojawienie się wody w pojeździe.	Otwory odpływowe skondensowanej wody są zatkane.	Oczyścić otwory odpływowe kropliny.
	Uszczelki są uszkodzone.	Skontaktować się z autoryzowanym centrum serwisowym lub firmą Dometic.
Klimatyzator dachowy nie włącza się.	Brak zasilania.	Należy sprawdzić dopływ prądu.
	Napięcie jest zbyt niskie ( $< 200\text{ V}$ ).	Skontaktować się z autoryzowanym centrum serwisowym lub firmą Dometic.
	Przetwornik napięcia jest uszkodzony.	Skontaktować się z autoryzowanym centrum serwisowym lub firmą Dometic.
	Jeden z czujników temperatury jest uszkodzony.	Skontaktować się z autoryzowanym centrum serwisowym lub firmą Dometic.
	Bezpiecznik zasilania ma zbyt niski amperaż.	Skontaktować się z autoryzowanym centrum serwisowym lub firmą Dometic.

Usterka	Możliwa przyczyna	Proponowane rozwiązanie
Klimatyzator dachowy nie wyłącza się.	Jeden z czujników temperatury jest uszkodzony.	Skontaktować się z autoryzowanym centrum serwisowym lub firmą Dometic.
	Bezpiecznik zasilania ma zbyt niski amperaż.	Skontaktować się z autoryzowanym centrum serwisowym lub firmą Dometic.
<b>Dotyczy tylko FreshJet FJX4233EEH/FJX4333E(E-H)/FJX7333IHP/FJX7337IHP/FJX7457IHP:</b> Klimatyzator dachowy stale samoczynnie się wyłącza.	Zadziałał czujnik oblodzenia.	Temperatura na zewnątrz jest zbyt niska lub wszystkie dysze nawiewu są zamknięte.
Na wyświetlaczu pojawi się informacja: P0	Przegrzanie lub przetężenie w module IPM	Skontaktować się z autoryzowanym centrum serwisowym lub firmą Dometic.
Na wyświetlaczu pojawi się informacja: P1	Zabezpieczenie podnapięciowe	Skontaktować się z autoryzowanym centrum serwisowym lub firmą Dometic.
Na wyświetlaczu pojawi się informacja: P2	Zabezpieczenie nadprądowe dla prądu przemiennego w jednostce	Skontaktować się z autoryzowanym centrum serwisowym lub firmą Dometic.
Na wyświetlaczu pojawi się informacja: P4	Zabezpieczenie lampy gazowej przed przegrzaniem	Skontaktować się z autoryzowanym centrum serwisowym lub firmą Dometic.
Na wyświetlaczu pojawi się informacja: P5	Zabezpieczenie węzownicy parownika (tryb chłodzenia)	Skontaktować się z autoryzowanym centrum serwisowym lub firmą Dometic.
Na wyświetlaczu pojawi się informacja: P6	Zabezpieczenie węzownicy skraplacza (tryb chłodzenia)	Skontaktować się z autoryzowanym centrum serwisowym lub firmą Dometic.
Na wyświetlaczu pojawi się informacja: P7	Zabezpieczenie węzownicy parownika (tryb ogrzewania)	Skontaktować się z autoryzowanym centrum serwisowym lub firmą Dometic.
Na wyświetlaczu pojawi się informacja: P9	Odbiegająca od normy praca sprężarki lub brak możliwości jej uruchomienia	Skontaktować się z autoryzowanym centrum serwisowym lub firmą Dometic.
Na wyświetlaczu pojawi się informacja: E0	Błąd komunikacji	Skontaktować się z autoryzowanym centrum serwisowym lub firmą Dometic.
Na wyświetlaczu pojawi się informacja: E1	Błąd czujnika temperatury w pomieszczeniu	Skontaktować się z autoryzowanym centrum serwisowym lub firmą Dometic.
Na wyświetlaczu pojawi się informacja: E2	Błąd czujnika temperatury węzownicy parownika	Skontaktować się z autoryzowanym centrum serwisowym lub firmą Dometic.



Usterka	Możliwa przyczyna	Proponowane rozwiązanie
Na wyświetlaczu pojawi się informacja: E3	Błąd czujnika temperatury węzownicy skraplacza	Skontaktować się z autoryzowanym centrum serwisowym lub firmą Dometic.
Na wyświetlaczu pojawi się informacja: E7	Usterka czujnika temperatury zewnętrznej	Skontaktować się z autoryzowanym centrum serwisowym lub firmą Dometic.
Na wyświetlaczu pojawi się informacja: E8	Usterka czujnika temperatury lampy gazowej	Skontaktować się z autoryzowanym centrum serwisowym lub firmą Dometic.
Na wyświetlaczu pojawi się informacja: E9	Błąd napędu sprężarki lub modułu IPM	Skontaktować się z autoryzowanym centrum serwisowym lub firmą Dometic.
Na wyświetlaczu pojawi się informacja: EA	Błąd czujnika prądu	Skontaktować się z autoryzowanym centrum serwisowym lub firmą Dometic.
Na wyświetlaczu pojawi się informacja: EE	Błąd pamięci EEPROM jednostki zewnętrznej	Skontaktować się z autoryzowanym centrum serwisowym lub firmą Dometic.
Na wyświetlaczu pojawi się informacja: EL	Usterka komunikacji LIN-BUS/CI-BUS	Skontaktować się z autoryzowanym centrum serwisowym lub firmą Dometic.

## 13 Utylizacja



Opakowanie należy w miarę możliwości wrzucić do odpowiedniego pojemnika na odpady do recyklingu. Szczegółowe informacje na temat utylizacji produktu zgodnie z obowiązującymi przepisami można uzyskać w lokalnym zakładzie recyklingu lub u specjalistycznego dystrybutora.



Chroń środowisko naturalne! Akumulatorów i baterii nie należy wrzucać do pojemników na odpady komunalne. Uszkodzone akumulatory lub zużyte baterie należy przekazać do punktu sprzedaży lub odpowiedniego punktu zbiórki.

## 14 Gwarancja

Obowiązuje ustawowy okres gwarancji. W przypadku stwierdzenia uszkodzenia produktu należy zwrócić się do oddziału producenta w danym kraju (patrz [dometic.com/dealer](http://dometic.com/dealer)) lub do sprzedawcy produktu.

W celu naprawy lub rozpatrzenia gwarancji konieczne jest przesłanie następujących dokumentów:

- Kopii rachunku z datą zakupu
- Informacji o przyczynie reklamacji lub opisu wady

Uwaga: Samodzielne lub nieprofesjonalne wykonywanie napraw może mieć poważne skutki i prowadzić do utraty gwarancji.

## 15 Dane techniczne

11

FreshJet FJX4233M

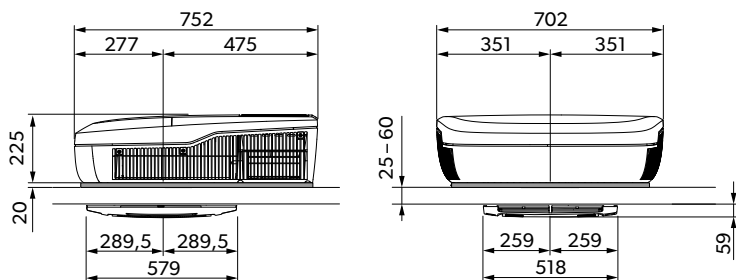

12

FJX4233EEH, FJX4333E(EH), FJX7333IHP

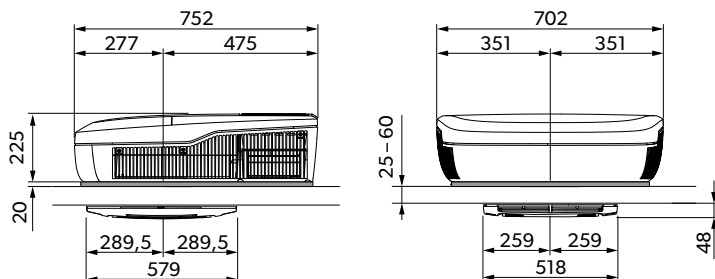

13

FreshJet FJX7337IHP

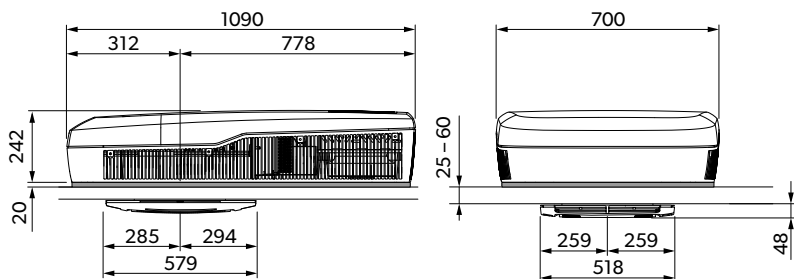

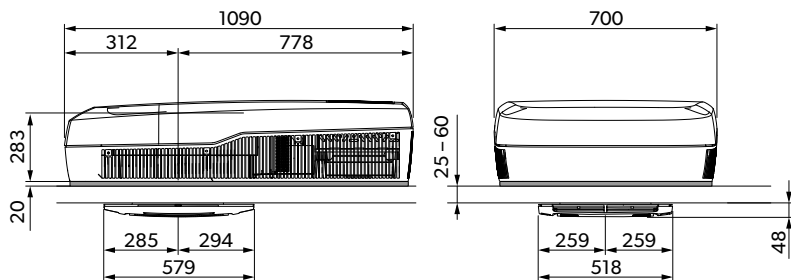

14

FreshJet FJX7457IHP



Zawiera fluorowane gazy cieplarniane Urządzenie zamknięte hermetycznie.

	<b>FreshJet FJX4233M</b>
Wydajność chłodnicza zgodnie z ISO 5151:	1500 W
Napięcie wejściowe AC:	220 V ... 240 V / 50 Hz
Prąd znamionowy chłodzenia:	< 3.3 A
Wymagany bezpiecznik:	4 A
Zakres temperatury roboczej:	- 2 °C ... 52 °C
Czynnik chłodniczy:	R410a
Ilość czynnika chłodniczego:	380 g
Równoważnik CO <sub>2</sub> :	0.793 t
Potencjał tworzenia efektu cieplarnianego (GWP):	2088
Stopień ochrony (jednostki dachowej):	IPX4
Poziom hałasu (przy najwyższym ustawieniu wentylatora)	< 70 dB(A)
Sugerowana maks. długość pojazdu (z izolowanymi ścianami):	< 5 m
Wymiary (dł. x szer. x wys.):	nys. <b>11</b> na stronie 354
Masa:	< 30 kg

	FreshJet FJX4233M		
Kontrola/certyfikat:			
	FreshJet FJX4233EEH	FreshJet FJX4333EEH	FreshJet FJX4333E
Wydajność chłodnicza zgodnie z ISO 5151:	1700 W	2200 W	2200 W
Wydajność grzewcza zgodnie z ISO 5151:	800 W	1000 W	–
Napięcie wejściowe AC:	220 V ... 240 V / 50 Hz		
Prąd znamionowy chłodzenia:	3.6 A	4.8 A	4.8 A
Prąd znamionowy ogrzewania:	< 5.2 A	< 5.2 A	–
Wymagany bezpiecznik:	4 A	5 A	6 A
Zakres temperatury roboczej:	– 2 °C ... 52 °C		
Czynnik chłodniczy:	R32		
Ilość czynnika chłodniczego:	320 g	360 g	360 g
Równoważnik CO <sub>2</sub> :	0.216 t	0.243 t	0.243 t
Potencjał tworzenia efektu cieplarnianego (GWP):	675		
Stopień ochrony (jednostki dachowej):	IPX4		
Poziom hałasu (przy najwyższym ustawieniu wentylatora)	< 70 dB(A)		
Sugerowana maks. długość pojazdu (z izolowanymi ścianami):	< 6 m	< 7 m	< 7 m
Wymiary (dł. x szer. x wys.):	rys. 12 na stronie 354		
Masa:	< 30 kg	< 30 kg	< 30 kg
Kontrola/certyfikat:			

	FreshJet FJX7333IHP	FreshJet FJX7337IHP	FreshJet FJX7457IHP
Wydajność chłodnicza zgodnie z ISO 5151:	2200 W	3000 W	3500 W
Wydajność grzewcza zgodnie z ISO 5151:	2000 W	2500 W	3000 W
Napięcie wejściowe AC:	220 V ... 240 V / 50 Hz ... 60 Hz	220 V ... 240 V / 50 Hz ... 60 Hz	220 V ... 240 V / 50 Hz ... 60 Hz
Prąd znamionowy chłodzenia:	< 7.5 A	< 7.5 A	< 7.5 A
Prąd znamionowy ogrzewania:	< 6.1 A	< 6.1 A	< 6.1 A
Wymagany bezpiecznik:	6 A	6 A	6 A
Zakres temperatury roboczej:	- 2 °C ... 52 °C	- 2 °C ... 52 °C	- 2 °C ... 52 °C
Czynnik chłodniczy:	R32	R32	R32
Ilość czynnika chłodniczego:	420 g	480 g	650 g
Równoważnik CO <sub>2</sub> :	0.2835 t	0.3240 t	0.43875 t
Potencjał tworzenia efektu cieplarnianego (GWP):		675	
Stopień ochrony (jednostki dachowej):		IPX4	
Poziom hałas (przy najwyższym ustawieniu wentylatora)		< 70 dB(A)	
Sugerowana maks. długość pojazdu (z izolowanymi ścianami):	< 7 m	< 7 m	> 8 m
Wymiary (dł. x szer. x wys.):	rys. 12 na stronie 354	rys. 13 na stronie 354	rys. 14 na stronie 355
Masa:	< 30 kg	< 35 kg	< 40 kg
Kontrola/certyfikat:			

## Slovak

1	Important notes.....	358
2	Vysvetlenie symbolov.....	358
3	Bezpečnostné pokyny.....	359
4	Používanie v súlade s určením.....	360
5	Vysvetlenie symbolov na spotrebiči.....	360
6	Technické limity a podmienky.....	361
7	Technický opis.....	361
8	Pred prvým použitím.....	367
9	Obsluha.....	367
10	Čistenie strešnej klimatizácie.....	375
11	Údržba.....	375
12	Odstraňovanie porúch.....	377
13	Likvidácia.....	380
14	Záruka.....	380
15	Technické údaje.....	380

## 1 Important notes

Dôkladne si prečítajte tento návod a dodržiavajte všetky pokyny, usmernenia a varovania uvedené v tomto návode k výrobku, aby bolo zaručené, že výrobok bude vždy správne nainštalovaný, používaný a udržiavaný. Tento návod **MUSÍ** zostať priložený k výrobku.

Používaním tohto výrobku týmto potvrdzujete, že ste si dôkladne prečítali všetky pokyny, usmernenia a varovania a že rozumiete a súhlasíte s dodržiavaním všetkých uvedených podmienok. Súhlasíte, že tento výrobok budete používať iba v súlade so zamýšľaným použitím a v súlade s pokynmi, usmerneniami a varovaniami uvedenými v tomto návode k výrobku, ako aj v súlade so všetkými platnými zákonmi a nariadeniami. V prípade, že si neprečítate a nebudete sa riadiť pokynmi a varovaniami uvedenými v tomto návode, môže mať za následok vaše poranenie alebo poranenie iných osôb, poškodenie vášho výrobku alebo poškodenie majetku v jeho blízkosti. Tento návod na obsluhu výrobku vrátane pokynov, usmernení a varovaní, a súvisiaca dokumentácia môže podliehať zmenám a aktualizáciám. Najaktuálnejšie informácie o výrobku nájdete na adrese [documents.dometic.com](http://documents.dometic.com).

## 2 Vysvetlenie symbolov



**NEBZPEČENSTVO!** Označuje nebezpečnú situáciu, ktorej následkom je smrť alebo vážne zranenie, ak sa jej nezabráni.



**VÝSTRAHA!** Označuje nebezpečnú situáciu, ktorej následkom je smrť alebo vážne zranenie, ak sa jej nezabráni.



**UPOZORNENIE!** Označuje nebezpečnú situáciu, ktorej následkom môže byť malé alebo stredne ťažké zranenie, ak sa jej nezabráni.



**POZOR!** Označuje nebezpečnú situáciu, ktorej následnom môže byť malé alebo stredne ťažké zranenie, ak sa jej nezabráni.



**Poznámka** Dopĺňujúce informácie týkajúce sa obsluhy produktu.

### 3 Bezpečnostné pokyny



**VÝSTRAHA! Nedodržanie týchto varovaní môže mať za následok smrť alebo vážne poranenie.**

- **Elektrické spotrebiče nie sú detské hračky.** Toto zariadenie nie je určené na používanie osobami (vrátane detí) s obmedzenými fyzickými, zmyslovými alebo duševnými schopnosťami alebo nedostatkom skúsenosti a znalostí, pokiaľ nie sú pod primeraným dohľadom alebo neboli poučené.
- Dohliadnite na to, aby sa deti nehrali so zariadením.
- Toto zariadenie smú používať deti od 8 rokov a osoby so zníženými psychickými, zmyslovými alebo mentálnymi schopnosťami a vedomosťami, keď sú pod primeraným dohľadom alebo keď boli poučené o bezpečnom používaní zariadenia a chápu, aké riziká z toho vyplývajú.
- Čistenie nesmú vykonávať deti bez dozoru.
- Každá osoba, ktorá poverená prácami na chladiacom okruhu alebo jeho otvorením, musí mať platný certifikát vydaný akreditovaným certifikačným orgánom v odvetví, ktorý autorizuje jej kompetenciu pre bezpečnú manipuláciu s chladiacimi prostriedkami v súlade s uznávanými špecifikácia v danom odvetví.
- Údržba sa smie vykonávať iba podľa odporúčaní výrobcu zariadenia. Údržba a opravy vyžadujúce si asistenciu iného kvalifikovaného personálu sa musia vykonávať pod dohľadom osoby, ktorá je kompetentná pre používanie horľavých chladiacich prostriedkov.
- Opravy spotrebiča smie vykonáva iba kvalifikovaný personál, ktorý je oboznámený s rizikami, ktoré sú s tým spojené, a s príslušnými predpismi. Neodborné opravy môžu zapríčiniť vážne ohrozenia. V prípade potreby opravy sa obráťte na servisné stredisko vo vašej krajine (pozri [dometic.com/dealer](http://dometic.com/dealer)).
- Pri práci na spotrebiči vždy prerušte prívod elektrického prúdu.
- Spotrebič sa musí skladovať v miestnosti bez zdrojov zapalovania s nepretržitou prevádzkou, ako napríklad otvorený plameň, plynový spotrebič v prevádzke alebo elektrický ohrievač v prevádzke.
- Spotrebič neprepichujte alebo nehádzte do ohňa.
- Pamätajte si, že chladivá nemusia vydávať žiadny zápach.
- Nepoužívajte spotrebič v blízkosti horľavých kvapalín alebo v uzavretých priestoroch.
- Postarajte sa, aby horľavé predmety neboli skladované alebo namontované v blízkosti výstupu vzduchu. Musí byť dodržaná minimálna vzdialenosť 50 cm.
- Neblokujte ani nezakrývajte vetracie otvory.
- Nepoškodzte chladiaci okruh.
- Na hľadanie a detekciu únikov chladiwa sa v žiadnom prípade nesmú používať potenciálne zápalné zdroje. Halidový detektor (alebo akýkoľvek iný detektor s otvoreným plameňom) sa nesmie používať.
- Strešná klimatizácia sa musí inštalovať do vozidla s podlahovou plochou väčšou ako 4 m<sup>2</sup>.



### UPOZORNENIE! Nedodržanie týchto upozornení môže mať za následok drobné alebo stredne ťažké poranenie.

- Nesiahajte do výstupov vzduchu a do spotrebiča nevkladajte žiadne cudzie predmety.
- V prípade požiaru neskladajte horný kryt spotrebiča. Namiesto toho použite povolené hasiace prostriedky. Na hasenie nepoužívajte vodu.
- Ak je prívodný napájací kábel poškodený, musí ho vymeniť výrobca, jeho servisný technik alebo podobne kvalifikovaný personál, aby sa predišlo ohrozeniam.
- V prípade, že spotrebič obsahuje ionizátor, informujte sa u svojho lekára, ak máte zdravotné problémy. Ionizátor dokáže produkovať ozón (O<sub>3</sub>) v malých množstvách. Ak trpíte pľúcny ochorením, astmou, ochorením srdca, respiračným ochorením, respiračnými problémami alebo ste citliví na ozón, konzultujte so svojím lekárom, či je používanie tohto zariadenia bezpečné pre vaše zdravie.



### POZOR! Nebezpečenstvo poškodenia

- Nepoužívajte prostriedky na urýchlenie procesu odmravovania alebo iné prostriedky na čistenie, než tie, ktoré odporučil výrobca.
- Spotrebič sa musí skladovať tak, aby sa predišlo vzniku mechanického poškodenia.
- Na prístroji neuskutočňujte žiadne zmeny alebo prestavby!
- S namontovaným spotrebičom nesmiete vojsť s obvytným automobilom do automatickej automyvárne.
- Ak sa vyskytne porucha v chladiacom okruhu, musí ho skontrolovať a opraviť výrobca, jeho servisný technik alebo podobne kvalifikovaný personál, aby sa predišlo ohrozeniam.

## 4 Používanie v súlade s určením

Strešná klimatizácia FreshJet FJX je určená iba pre montáž na strechy karavanov alebo rekreačných vozidiel za účelom chladenia.

Strešná klimatizácia **nie** je vhodná pre vlaky, rodinné domy a byty. Strešná klimatizácia **nie** je vhodná pre montáž do stavebných, poľnohospodárskych alebo podobných pracovných strojov.

Tento výrobok je vhodný iba na použitie na určený účel a použitie v súlade s týmto návodom.

Tento návod obsahuje informácie, ktoré sú nevyhnutné pre správnu inštaláciu a/alebo obsluhu výrobku. Chybná inštalácia a/alebo nesprávna obsluha či údržba bude mať za následok neuspokojivý výkon a možnú poruchu.

Výrobca nenesie žiadnu zodpovednosť za akékoľvek poranenia či škody na výrobku spôsobené:

- nesprávnou montážou alebo pripojením vrátane nadmerného napätia
- nesprávnou údržbou alebo použitím iných ako originálnych náhradných dielov poskytnutých výrobcom
- Zmeny produktu bez výslovného povolenia výrobcu
- Použitie na iné účely než na účely opísané v návode

Firma Dometic si vyhradzuje právo na zmenu vzhľadu a technických parametrov výrobku.

## 5 Vysvetlenie symbolov na spotrebiči



Pozor! Materiál s nízkou rýchlosťou horenia.





Prečítajte si návod na obsluhu.



Prečítajte si servisnú príručku.

## 6 Technické limity a podmienky

Strešná klimatizácia je určená pre vozidlá s hrúbkou strechy 25 mm ... 60 mm. Funkcia strešnej klimatizácie je zaručená pri teplote okolia v rozsahu  $-2\text{ }^{\circ}\text{C}$  ...  $52\text{ }^{\circ}\text{C}$ . Strešná klimatizácia je navrhnutá pre montáž v rozsahu  $\pm 10^{\circ}$  od horizontálnej roviny. Výkon strešnej klimatizácie sa môže znížiť, ak je vystavená silným vibráciám, ktoré napríklad spôsobuje zlý stav vozovky.

## 7 Technický opis

Strešná klimatizácia FreshJet FJX4233M privádza do interiéru studený vzduch, ktorý neobsahuje prach a nečistoty a môže byť zbavený vlhkosti.

Strešná klimatizácia FreshJet FJX4233EEH/FJX4333E(EH)/FJX7333IHP/FJX7337IHP/FJX7457IHP privádza do interiéru studený alebo teplý vzduch, ktorý neobsahuje prach a nečistoty a môže byť zbavený vlhkosti.

Strešná klimatizácia dokáže znížiť teplotu interiéru vozidla na určitý stupeň, ktorý závisí od typu vozidla, teploty okolia a chladiaceho výkonu strešnej klimatizácie. Ak je vonkajšia teplota nižšia ako  $16\text{ }^{\circ}\text{C}$  strešná klimatizácia už viac nechladí.

Strešná klimatizácia sa ovláda s nasledujúcimi ovládacími prvkami:

- Ovládací panel

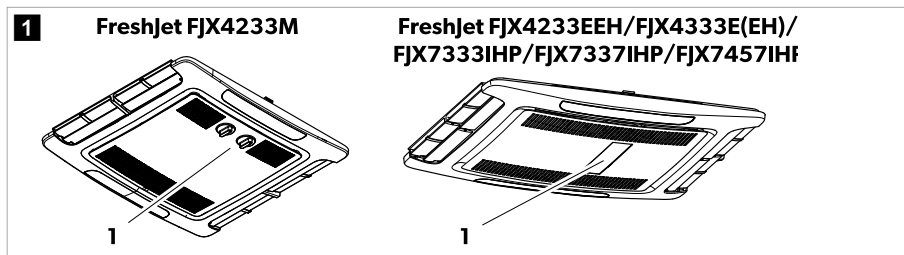

- Diaľkové ovládanie (iba modely FJX4233EEH/FJX4333E(EH)/FJX7333IHP/FJX7337IHP/FJX7457IHP)

### 7.1 Zoznam modelov

Nasledujúca tabuľka uvádza, ktorá funkcia sa vzťahuje na špecifický model:

- Funkcia je k dispozícii

○ Funkciu je možné pridať

	FJX4233M	FJX4233EEH	FJX4333EEH	FJX4333E	FJX7333IHP	FJX7337IHP	FJX7457IHP
Automaticky		●	●	●	●	●	●
Chladenie	●	●	●	●	●	●	●
Ohrievanie		●	●	○	●	●	●
Vetranie	●	●	●	●	●	●	●
Odvlhčovanie		●	●	●	●	●	●
Čistič vzduchu	○	●	●	○	●	●	●
ADB svetlo		●	●	○	●	●	●
Vonkajšie osvetlenie					●	●	●
Časovač		●	●	●	●	●	●
Sleep (Spánok)		●	●	●	●	●	●
Soft Start			●	○	●	●	●

## 7.2 Ovládací panel FreshJet FJX4233M

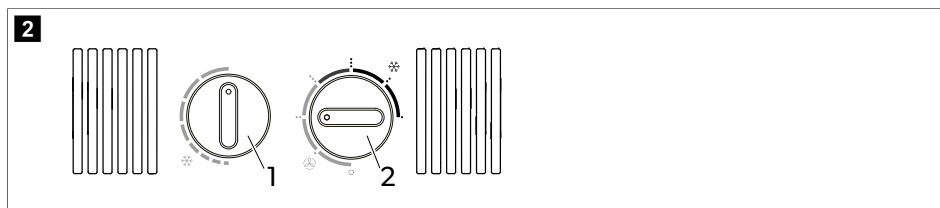

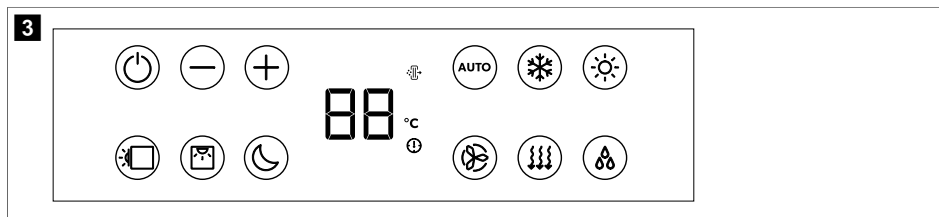

Gombík	Opis
	Zvolí teplotu. Otočte doprava pre vyšší chladiaci výkon.
	Zapne alebo vypne strešnú klimatizáciu a zvolí intenzitu cirkulácie vzduchu v režime Vetrania (☪) alebo intenzitu chladenia v režime Chladenie (❄).

### 7.3 Ovládací panel FreshJet FJX4233EEH/FJX4333E(EH)/FJX7333IHP/ FJX7337IHP/FJX7457IHP



















Symbol	Opis
	Zapne strešnú klimatizáciu alebo je prepne do režimu pohotovosti.
	Zvýši aktuálne zobrazenú hodnotu.
	Zníži aktuálne zobrazenú hodnotu.
	Spáruje s Bluetooth/WLAN, keď sú súčasne stlačené obe tlačidlá.
	Zapne alebo vypne ambientné osvetlenie v strešnej jednotke.
	Zapne alebo vypne ambientné osvetlenie v skrinke rozvádzania vzduchu.
	Aktivuje funkciu spánku (Sleep) (Pridavné funkcie (iba FJX4233EEH/FJX4333E(EH)/FJX7333IHP/FJX7337IHP/FJX7457IHP) na strane 366).
	Zobrazí nastavenú teplotu a indikuje stupeň ventilátora, keď je nastavený ventilátor.
	Indikuje, že režim čistenia vzduchu AirPurifier je aktívny.
	Indikuje, že teplota je zobrazená v stupňoch Celzia.
	Indikuje, že časovač je nastavený.
	Aktivuje/deaktivuje automatický režim (Režimy klimatizácie (iba FJX4233EEH/FJX4333E(EH)/FJX7333IHP/FJX7337IHP/FJX7457IHP) na strane 366).
	Aktivuje/deaktivuje režim chladenia (Režimy klimatizácie (iba FJX4233EEH/FJX4333E(EH)/FJX7333IHP/FJX7337IHP/FJX7457IHP) na strane 366).
	Aktivuje/deaktivuje režim vyhrievania (Režimy klimatizácie (iba FJX4233EEH/FJX4333E(EH)/FJX7333IHP/FJX7337IHP/FJX7457IHP) na strane 366).
	Nastavuje otáčky ventilátora medzi Low, Med, High, Turbo alebo Auto (pri zmene ich na krátky čas zobrazí ako 1, 2, 3, 4 alebo AA na skrinke rozvádzania vzduchu).

Symbol	Opis
	Aktivuje/deaktivuje ventiláciu (Režimy klimatizácie (iba FJX4233EEH/FJX4333E(EH)/FJX7333IHP/FJX7337IHP/FJX7457IHP) na strane 366). Cirkuluje vzduch bez vyhrievania alebo chladenia.
	Aktivuje/deaktivuje odvlhčovanie (Režimy klimatizácie (iba FJX4233EEH/FJX4333E(EH)/FJX7333IHP/FJX7337IHP/FJX7457IHP) na strane 366).

## 7.4 Diaľkové ovládanie FreshJet FJX4233EEH/FJX4333E(EH)/FJX7333IHP/ FJX7337IHP/FJX7457IHP





Ovládacie a indikačné prvky obr. **4** na strane 364:

Tlačidlo	Opis
—	<p><b>Displej</b></p> <p>Zobrazuje nasledujúce údaje:</p> <ul style="list-style-type: none"> <li>• Čas</li> <li>• Navolená teplota v miestnosti (cieľová hodnota) v stupňoch °C</li> <li>• Skutočná teplota priestoru</li> <li>• Režim klimatizácie</li> <li>• Rýchlosť ventilátora</li> <li>• Symboly pre aktívne prídavné funkcie</li> <li>• Stav batérie</li> </ul>
	Zapne strešnú klimatizáciu alebo ju prepne do pohotovostného režimu.
	Zvýši aktuálne zobrazenú hodnotu.
	Zníži aktuálne zobrazenú hodnotu.
	Zvolí otáčky ventilátora (Manuálna voľba otáčok ventilátora na strane 370).
	Zvolí režim klimatizácie (Režimy klimatizácie (iba FJX4233EEH/FJX4333E(EH)/FJX7333IHP/FJX7337IHP/FJX7457IHP) na strane 366). Zobrazí sa príslušný symbol.
	Aktivuje funkciu spánku (Sleep) (Prídavné funkcie (iba FJX4233EEH/FJX4333E(EH)/FJX7333IHP/FJX7337IHP/FJX7457IHP) na strane 366). Zobrazí sa symbol  .
	Potvrdí a uloží nastavenia.
	Nastaví časovač a hodiny.
	Zapne alebo vypne ambientné osvetlenie v skrinke rozvádzania vzduchu.
	<p>Stlačte raz pre zobrazenie aktuálnej vnútornej teploty. Zobrazí sa symbol .</p> <p>Stlačte dvakrát pre zobrazenie nastavenej teploty.</p>
	<p>Aktivuje funkciu I feel. Zobrazí sa symbol .</p> <p>Funkcia I feel každých 10 min upravuje cieľovú teplotu na aktuálnu teplotu nameranú diaľkovým ovládaním.</p>
	Zapne alebo vypne ambientné osvetlenie v strešnej jednotke.
	Indikuje, že batérie diaľkového ovládania sú vybité. Vymeňte batérie (Výmena batérií diaľkového ovládania na strane 373).
	Indikuje, že diaľkové ovládanie odosiela hodnoty do strešnej klimatizácie.





## 7.5 Režimy klimatizácie (iba FJX4233M)

Strešná klimatizácia disponuje nasledujúcimi režimami klimatizácie:

Režim klimatizácie	Zobrazený symbol	Opis
Chladenie		Nastavíte teplotu a nastavenia ventilátora, a strešná klimatizácia schladí interiér na túto teplotu.
Vetranie		Nastavíte nastavenia ventilátora a strešná klimatizácia cirkuluje vzduch bez vyhrievania alebo chladenia.





## 7.6 Režimy klimatizácie (iba FJX4233EEH/FJX4333E(EH)/FJX7333IHP/FJX7337IHP/FJX7457IHP)

Strešná klimatizácia disponuje nasledujúcimi režimami klimatizácie:

Režim klimatizácie	Zobrazený symbol	Opis
Automaticky	<b>A</b>	Nastavíte teplotu a strešná klimatizácia schladí alebo vyhrejé interiér na túto teplotu a reguláciou potrebných otáčok ventilátora.
Chladenie		Nastavíte teplotu a nastavenia ventilátora, a strešná klimatizácia schladí interiér na túto teplotu.
Ohrievanie		<b>Okrem modelu FJX4333E:</b> Nastavíte teplotu a nastavenia ventilátora, a strešná klimatizácia zohreje interiér na túto teplotu. Ventilátor sa spustí len po 2 min (na nízkych otáčkach) a potom, približne po 5 min sa prepne na nastavené otáčky (potom ako výparník dosiahne teplotu).
Vetranie		Nastavíte nastavenia ventilátora a strešná klimatizácia cirkuluje vzduch bez vyhrievania alebo chladenia.
Odvlhčovanie vzduchu		Strešná klimatizácia odstraňuje vlhkosť zo vzduchu bez vyhrievania alebo chladenia interiéru, čím znižuje relatívnu vlhkosť vzduchu.
Čistič vzduchu		<b>Okrem modelu FJX4333E:</b> Strešná klimatizácia ionizuje vzduch, čím zo vzduchu zbiera prach a častičky vrátane vírusov a baktérií.

## 7.7 Prídavné funkcie (iba FJX4233EEH/FJX4333E(EH)/FJX7333IHP/FJX7337IHP/FJX7457IHP)

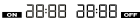
Strešná klimatizácia disponuje nasledujúcimi prídavnými funkciami:

Pridavná funkcia	Hlásenie na displeji	Opis
Časovač		Strešná klimatizácia sa zapne v nastavenom čase.
		Strešná klimatizácia sa vypne v nastavenom čase.
		Strešná klimatizácia sa zapne a vypne v nastavených časoch.
Sleep (Spánok)		Funkcia spánku zníži otáčky ventilátora a otáčky kompresora pre zníženie úrovne hluku kvôli príjemnému spánku.
I Feel		Diaľkové ovládanie meria vnútornú teplotu a toto meranie prenáša do strešnej klimatizácie každých 10 min. Strešná klimatizácia prispôsobí cieľovú hodnotu tomuto meraniu.
Soft Start		<b>Okrem modelu FJX4233EEH:</b> Špičkový prúd, ktorý začne kompresor generovať je znížený funkciou mäkkého štartu (Soft Start). Ak sa generátor používa ako zdroj napájania, generátor sa nepreťažší.

## 8 Pred prvým použitím

### Kontroly pred uvedením zariadenia do prevádzky

Pred zapnutím strešnej klimatizácie dodržte nasledujúce body:

1. Skontrolujte, či sa napájacie napätie a frekvencia zhodujú s hodnotami uvedenými na Technické údaje na strane 380.
2. Uistite sa, že otvory prívodu vzduchu a vzduchové dýzy nie sú zakryté alebo zablokované. Všetky vetracie mriežky nesmú byť nikdy blokované alebo zakryté, aby strešná klimatizácia dokázala pracovať na maximálny výkon.

### Príprava diaľkového ovládania (iba modely FreshJet FJX4233EEH/FJX4333E(EH)/FJX7333IHP/FJX7337IHP/FJX7457IHP)

3. Vložte batérie (Výmena batérií diaľkového ovládania na strane 373).

### Nastavenie času (iba modely FreshJet FJX4233EEH/FJX4333E(EH)/FJX7333IHP/FJX7337IHP/FJX7457IHP)

4. Nastavte aktuálny čas (Nastavenie aktuálneho času na strane 370).

## 9 Obsluha

### 9.1 Tipy pre lepšie používanie

Nasledujúce tipy pomôžu optimalizovať výkon vašej strešnej klimatizácie:

- Zlepšite tepelnú izoláciu vozidla tak, že utesníte medzeru a na okná dáte antireflexné rolety alebo závesy.
- Zvoľte primeranú teplotu a stupeň ventilácie.
- Vzduchové dýzy účelne nastavte.
- Postarajte sa, aby vzduchové dýzy a otvory prívodu vzduchu neboli zakryté handrami, papierom alebo inými predmetmi.

- **Iba FreshJet FJX4233EEH/FJX4333E(EH)/FJX7333IHP/FJX7337IHP/FJX7457IHP:** Ak je vozidlo dlhú dobu vystavené priamemu slnečnému žiareniu: Strešnú klimatizáciu prevádzkujte nejakú dobu v režime Vetranie (🌀) s otvorenými oknami, skôr než zapnete režim Chladenie (❄️).
- **Iba FreshJet FJX4233EEH/FJX4333E(EH)/FJX7333IHP/FJX7337IHP/FJX7457IHP:** V režime Chladenie (❄️) sa podľa možnosti vyhnite otváraníu dverí a okien.

## 9.2 Základné pokyny k obsluhu

Strešná klimatizácia FreshJet FJX4233M má tri prevádzkové režimy:

Prevádzkový režim	Opis
Vyp	Strešná klimatizácia je vypnutá.
Chladenie	Strešná klimatizácia chladí interiér.
Vetranie	Strešná klimatizácia cirkuluje vzduch bez chladenia.

Strešná klimatizácia FreshJet FJX4233EEH/FJX4333E(EH)/FJX7333IHP/FJX7337IHP/FJX7457IHP má dva prevádzkové režimy:

Prevádzkový režim	Opis
Pohotovostný režim:	Strešná klimatizácia je pripravená na prevádzku a je možné ju zapnúť diaľkovým ovládaním. Ambientné osvetlenie je k dispozícii. Diaľkové ovládanie je tiež v pohotovostnom režime, ale diaľkové ovládanie môžete zapnúť nezávisle od strešnej klimatizácie.
Zap	Strešná klimatizácia klimatizuje vzduch v interiéri.

## 9.3 Dometic FJX4233M

Informácie uvedené v tejto kapitole sa vzťahujú iba na strešné klimatizácie FJX4233M.

### 9.3.1 Zapnutie a vypnutie strešnej klimatizácie

Strešná klimatizácia disponuje dvomi režimami klimatizácie:

- Režim Vetranie (🌀)
- Režim Chladenie (❄️)



**Poznámka** Predtým, než prepnete z režimu Vetranie do režimu Chladenie, počkajte aspoň 30 s. Inak môže zapínací prúd vyhodiť poisťku.

Každý režim má tri nastavenia:

- ..: Low (nízke)
- ...: Medium (stredné)
- ....: High (vysoké)



- > Zapnite strešnú klimatizáciu otočením regulátora  do polohy režimu Vetranie () alebo do polohy režimu Chladenie () a zvolte želané nastavenie.
- ✓ Strešná klimatizácia je zapnutá a pracuje s hodnotami, ktoré boli nastavené pred jej vypnutím.
- > Vypnite strešnú klimatizáciu otočením regulátora  do polohy 0.

### 9.3.2 Nastavenie teploty

- > Otočte regulátor  do požadovanej polohy. Otočenie regulátora doprava znamená nižšiu teplotu.
- ✓ Teplota na strešnej klimatizácii je nastavená.

## 9.4 FreshJet FJX4233EEH/FJX4333E(EH)/FJX7333IHP/FJX7337IHP/FJX7457IHP

Informácie uvedené v tejto kapitole sa vzťahujú iba na strešné klimatizácie FreshJet FJX4233EEH/FJX4333E(EH)/FJX7333IHP/FJX7337IHP/FJX7457IHP.

### 9.4.1 Používanie diaľkového ovládania

Pri používaní diaľkového ovládania zvažte nasledujúce tipy:

- Nasmerujte diaľkové ovládanie na IR prijímač ovládacieho panela.
- Keď stlačíte tlačidlo, príslušné nastavenia a hodnoty sa priamo odošlú do strešnej klimatizácie.
- Strešná klimatizácia pípnutím potvrdí prijatie údajov.
- Zvyšovanie a znižovanie hodnôt je rýchlejšie, keď stlačíte a podržíte tlačidlo + alebo –.
- V režime pohotovosti je displej diaľkového ovládania tiež neaktívny. Diaľkové ovládanie môžete prepnúť do pohotovostného režimu nezávisle od strešnej klimatizácie.
- > Ak chcete prepnúť iba diaľkové ovládanie z alebo do pohotovostného režimu, stlačte tlačidlo  a diaľkovým ovládaním nemierite na IR prijímač ovládacieho panela.

### 9.4.2 Zapnutie strešnej klimatizácie a prepnutie do pohotovostného režimu

 **Poznámka** Keď je strešná klimatizácia zapnutá, pracuje s hodnotami, ktoré boli nastavené pred jej prepnutím do pohotovostného režimu. Strešnú klimatizáciu je možné vypnúť len odpojením od zdroja napájania.





- > Stlačte tlačidlo  na diaľkovom ovládaní alebo tlačidlo  na ovládacom paneli pre zapnutie strešnej klimatizácie alebo jej prepnutie do pohotovostného režimu.

### 9.4.3 Voľba režimu klimatizácie

- > Zvoľte želaný režim klimatizácie s pomocou tlačidla MODE (Režimy klimatizácie (iba FJX4233EEH/FJX4333E(EH)/FJX7333IHP/FJX7337IHP/FJX7457IHP) na strane 366).
- ✓ Strešná klimatizácia pípnutím potvrdí prijatie hodnôt. Strešná klimatizácia sa zapne do zvoleného režimu klimatizácie.

### 9.4.4 Manuálna voľba otáčok ventilátora

Otáčky ventilátora je možné ručne navoliť vo všetkých režimoch, okrem režimu Automaticky (**A**) a Odvlhčovanie (☉).

Hlásenie na displeji	Opis
	Nízke otáčky ventilátora
	Stredné otáčky ventilátora
	Vysoké otáčky ventilátora.
	Veľmi vysoké otáčky ventilátora.
	Režim Automaticky (otáčky ventilátora sa nastavujú podľa teploty okolia).

- > Stlačte tlačidlo diaľkového ovládania (⊗) alebo tlačidlo (⊗) ovládacieho panela pre voľbu želaných otáčok ventilátora.
- ✓ Strešná klimatizácia pípnutím potvrdí prijatie hodnôt.  
Nové otáčky ventilátora sú nastavené.

### 9.4.5 Nastavenie teploty

V režimoch Automaticky (**A**), Chladenie (❄), Kúrenie (☀) a Odvlhčovanie (☉) môžete nastaviť teplotu v rozsahu 16 °C a 31 °C.

- > Použite tlačidlo + alebo – na diaľkovom ovládaní pre nastavenie požadovanej teploty.
- ✓ Strešná klimatizácia vysokým tónom potvrdí prijatie hodnôt. Teplota na strešnej klimatizácii je nastavená.

### 9.4.6 Nastavenie aktuálneho času

Diaľkové ovládanie potrebuje na programovanie časovača aktuálny čas. Čas sa zobrazí na displeji diaľkového ovládania.

1. Stlačte a podržte tlačidlo (☺) aby ste sa dostali do režimu pre nastavenie času.
- ✓ Čas bliká na displeji diaľkového ovládača.
2. Tlačidlom + alebo – nastavte aktuálny čas. Stlačte a podržte tlačidlo + alebo – dlhšie ako 2 s, aby ste rýchlejšie zvýšili alebo znížili čas.
3. Stlačte tlačidlo SET, aby ste čas potvrdili.















### 9.4.7 Naprogramovanie časovača

Funkciu časovača môžete nastaviť požadovaný čas činnosti klimatizácie. Môžete nastaviť čas zapnutia, čas prepnutia do pohotovostného režimu alebo obe hodnoty.

Funkcia časovača sa nastaví pomocou diaľkového ovládania.



**Poznámka** Ak sa pri programovaní časovača nestlačí žiadne tlačidlo na diaľkovom ovládaní po dobu 15 s, diaľkové ovládanie sa prepne späť do počiatočného režimu.







- > Nastavte **časovač zapnutia** nasledujúcim spôsobom:
  - a) Zvoľte želaný režim klimatizácie a všetky požadované hodnoty (napríklad teplotu).
  - b) Ak je to nutné, prepnite strešnú klimatizáciu do pohotovostného režimu.  
Časovač zapnutia je možné nastaviť iba vtedy, keď je strešná klimatizácia v **pohotovostnom režime**.
  - c) Jedenkrát stlačte tlačidlo .
  - ✓ Na displeji diaľkového ovládania bliká symbol  **OFF**.
  - d) Tlačidlom + alebo – nastavte čas, kedy sa má strešná klimatizácia zapnúť.
  - e) Stlačte tlačidlo .  
Časovač zapnutia je nastavený. Strešná klimatizácia sa zapne v nastavenom čase so zvoleným režimom klimatizácie.
- > Nastavte **časovač prepnutia do pohotovostného režimu** nasledujúcim spôsobom:
  - a) Ak je to nutné, zapnite strešnú klimatizáciu.  
Časovač prepnutia do pohotovostného režimu je možné nastaviť iba vtedy, keď je strešná klimatizácia **zapnutá**.
  - b) Dvakrát stlačte tlačidlo .
  - ✓ Na displeji diaľkového ovládania bliká symbol  **ON**.
  - c) Tlačidlom + alebo – nastavte čas, kedy sa má strešná klimatizácia prepnúť do pohotovostného režimu.
  - d) Stlačte tlačidlo .  
Časovač prepnutia do pohotovostného režimu je nastavený. Strešná klimatizácia sa v nastavenom čase prepne do pohotovostného režimu.
- > Nastavte **časovač zapnutia** a **časovač prepnutia do pohotovostného režimu** nasledujúcim spôsobom:
  - a) Zvoľte želaný režim klimatizácie a všetky požadované hodnoty (napríklad teplotu).
  - b) Trikrát stlačte tlačidlo .
  - ✓ Na displeji diaľkového ovládania sa zobrazí symbol  **ON**  **OFF**. Symbol ON (ZAP) bliká.
  - c) Tlačidlom + alebo – nastavte čas, kedy sa má strešná klimatizácia zapnúť.
  - d) Stlačte tlačidlo .
  - ✓ Symbol **OFF** bliká.
  - e) Tlačidlom + alebo – nastavte čas, kedy sa má strešná klimatizácia prepnúť do pohotovostného režimu.
  - f) Stlačte tlačidlo .  
Časy zapnutia a prepnutia do pohotovostného režimu sú nastavené. Strešná klimatizácia sa zapne na nastavené časové obdobie.
- > Pre **zrušenie** prednastaveného časovača raz stlačte tlačidlo .
- ✓ Symbol  **OFF**  **ON** zhasne. Prednastavené hodnoty sa zahodia.

### 9.4.8 Nastavenie funkcie spánku

Funkcia spánku je dostupná len v režimoch Chladenie  alebo Kúrenie .

Funkcia spánku obmedzí otáčky ventilátora na nižší stupeň pre zníženie úrovne hluku kvôli nerušenému spánku.

**Iba FJX7333IHP/FJX7337IHP/FJX7457IHP:** Funkcia spánku navyše obmedzí otáčky ventilátora.

- > Pre aktivovanie funkcie spánku postupujte nasledujúcim spôsobom:
  - a) Nastavte požadovanú teplotu (Nastavenie teploty na strane 370).
  - b) Stlačte tlačidlo  na diaľkovom ovládaní alebo tlačidlo  na ovládacom paneli.
- ✓ Na displeji diaľkového ovládania sa objaví symbol . Funkcia spánku je aktivovaná.
  - > Pre deaktiváciu funkcie spánku stlačte tlačidlo  alebo tlačidlo  na diaľkovom ovládaní alebo tlačidlo  na ovládacom paneli.
- ✓ Symbol  na displeji diaľkového ovládania zhasne. Funkcia spánku je deaktivovaná.

### 9.4.9 Aktivácia funkcie I feel

Keď je táto funkcia aktívna, diaľkové ovládanie merania teploty v interiéri a odsiela túto hodnotu každých 10 minút do strešnej klimatizácie. Strešná klimatizácia prispôsobí cieľovú hodnotu tomuto meraniu. Funkcia I feel je aktívna len vtedy, keď je teplota v rozsahu +18 °C až +29 °C.

Diaľkové ovládanie by sa nemalo nachádzať v oblasti priestoru, ktorý je výrazne teplejší alebo chladnejší ako priemerná vnútorná teplota. Nesmie sa nechať položené napr. na slnku alebo pred strešnou klimatizáciou.

Keď sa teplota zvýši nad +29 °C alebo klesne pod +18 °C, funkcia I feel sa deaktivuje. Na displeji trikrát zabliká symbol  a potom zhasne.

1. Stlačte tlačidlo.
- ✓ Funkcia I feel sa aktivuje.

Na displeji sa zobrazí symbol .

2. Diaľkové ovládanie namierte tak, aby smerovalo na IR prijímač na ovládacom paneli. Inak hodnoty nie je možné odosielať do strešnej klimatizácie.







### 9.4.10 Ovládanie ambientného osvetlenia



**VÝSTRAHA! Nebezpečenstvo poranenia** Použitie vonkajšieho osvetlenia počas jazdy je zákonom zakázané.

Tlačidlo  na diaľkovom ovládaní je aktívne dokonca aj vtedy, keď je diaľkové ovládanie vypnuté.

#### Iba Freshjet FJX4233EEH/FJX4333E(EH)/FJX7333IHP/FJX7337IHP/FJX7457IHP:

- > Pre zapnutie alebo vypnutie vnútorného osvetlenia stlačte tlačidlo  diaľkovom ovládaní alebo na ovládacom paneli.
- ✓ Na displeji diaľkového ovládania sa raz zabliká symbol , keď je vnútorné osvetlenie **zapnuté**.
  - > Ak chcete stlmiť vnútorné osvetlenie postupujte nasledujúcim spôsobom:
    - a) Stlačte tlačidlo  na diaľkovom ovládaní alebo na ovládacom paneli na dobu 3 s.
    - b) Pri stlačení tlačidla  na diaľkovom ovládaní: Pre stlmenie vnútorného osvetlenia stlačte tlačidlo  na dobu 50 % až 100 %.
    - c) Pri stlačení tlačidla  na ovládacom paneli: Jas vnútorného osvetlenia cykluje v rozsahu 50 % až 100 %. Tlačidlo  pusťte po dosiahnutí želaného jasu.

#### Iba Freshjet FJX7333IHP/FJX7337IHP/FJX7457IHP:

- > Pre zapnutie alebo vypnutie externého osvetlenia stlačte tlačidlo  na ovládacom paneli.

## 9.4.11 Výmena batérií diaľkového ovládania



**Poznámka** Displej diaľkového ovládania svietiť dokonca aj vtedy, keď sa batérie vybíjajú. Vymeňte batérie, keď diaľkové ovládanie signalizuje slabé batérie.

- > Vymeňte batérie podľa obrázku.

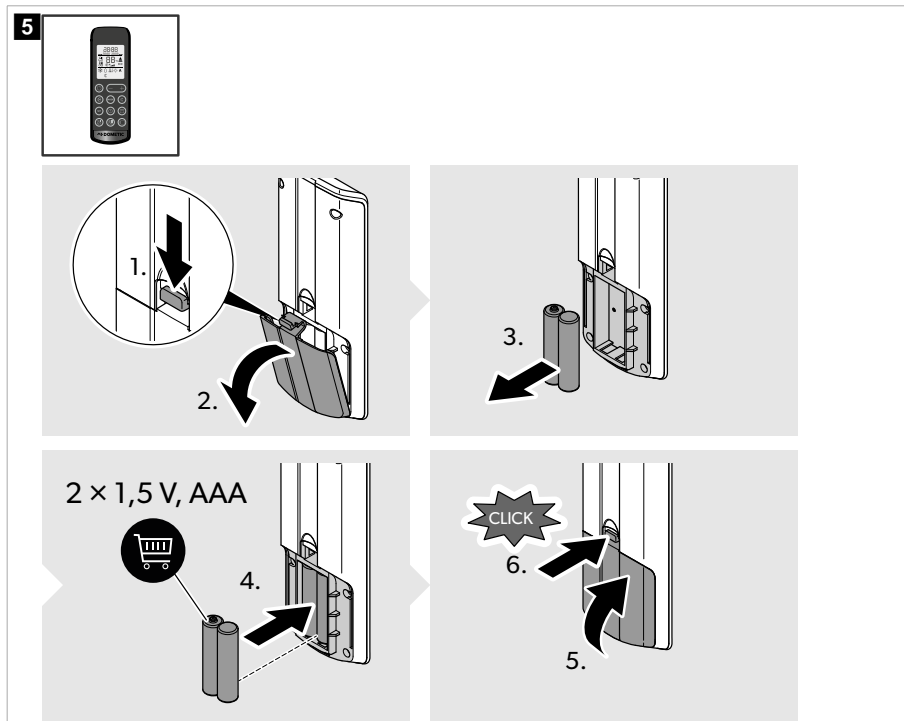

- ✓ Na displeji sa na zobrazia všetky symboly na 5 s.



Chráňte životné prostredie! Akumulátory a batérie nepatria do domového odpadu. Vaše poškodené akumulátory alebo prázdne batérie odovzdajte u predajcu alebo v zbernom mieste.

## 9.5 Regulácia prívodu vzduchu vo vozidle

Prúd vzduchu je možné nastaviť pozdĺž stropu alebo smerom k podlahe.

- > Otočte lamely vo vzduchových dýzach nezávisle v požadovaných smeroch.

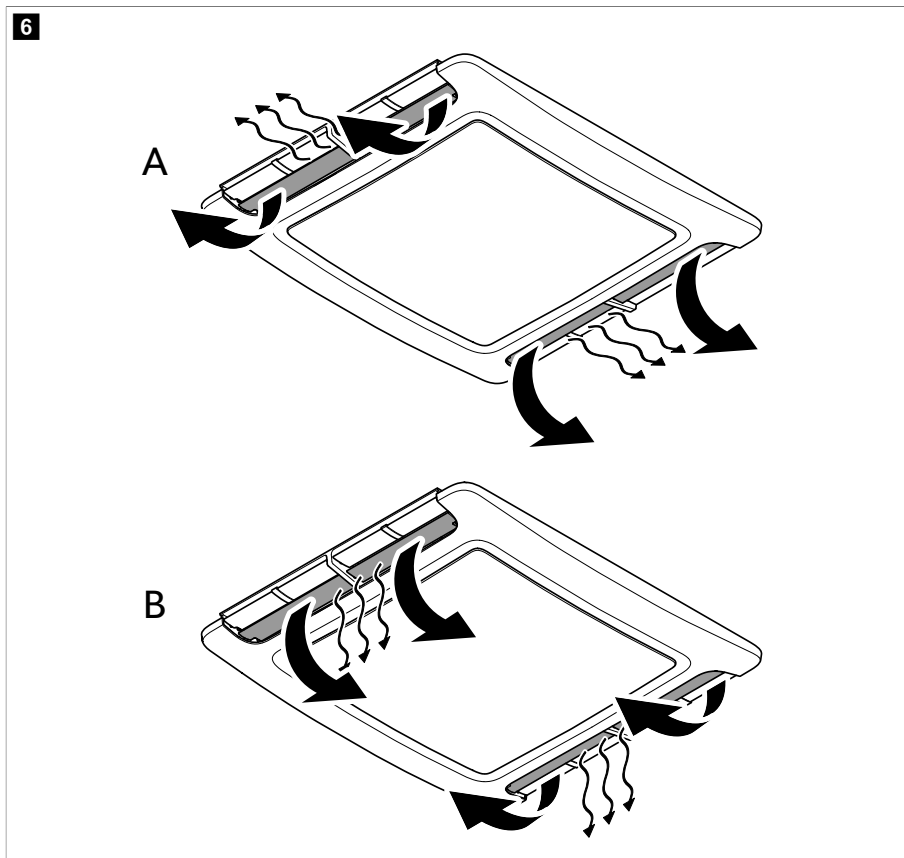

## 10 Čistenie strešnej klimatizácie



### POZOR! Nebezpečenstvo poškodenia

- Nepoužívajte prostriedky na urýchlenie procesu odmrazovania alebo iné prostriedky na čistenie, než tie, ktoré odporučil výrobca.
- Strešnú klimatizáciu nečistite vysokotlakovým čističom. Voda, ktorá by vnikla do strešného klimatizačného zariadenia, ho môže poškodiť.
- Na čistenie nepoužívajte ostré alebo tvrdé predmety, pretože by mohli poškodiť strešnú klimatizáciu.
- Nepoužívajte benzín, naftu alebo rozpúšťadlá.

1. Pravidelne odstraňujte lístie a iné nečistoty z prívodu vzduchu a vetracích mriežok strešnej klimatizácie. Počas odstraňovania nepoškodte vetracie mriežky.

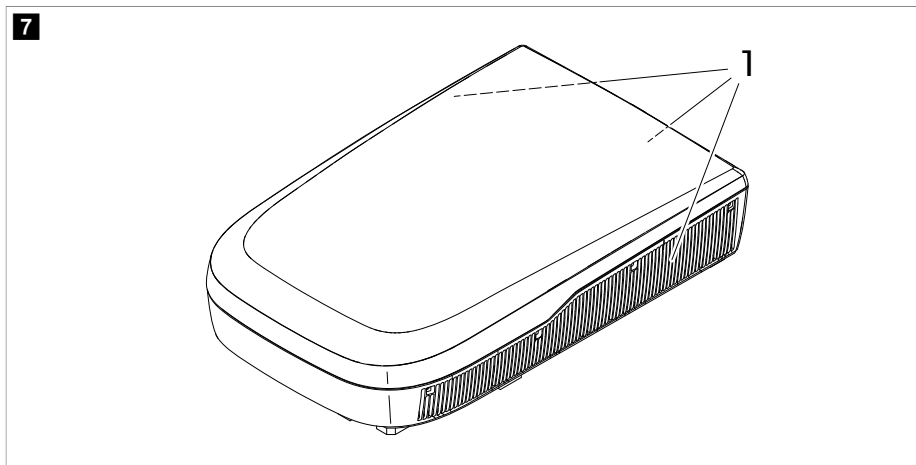

2. Príležitostne očistíte kryt strešnej jednotky a skrinky rozvádžania vzduchu s vlhkou handrou. Používajte iba vodu s jemným čistiacim prostriedkom.
3. **Iba FreshJet FJX4233EEH/FJX4333E(EH)/FJX7333IHP/FJX7337IHP/FJX7457IHP:** Diaľkové ovládanie príležitostne očistíte s jemne navlhčenou handrou. Očistíte displej s čistiacou handričkou na okuliare.
4. **Iba modely FreshJet FJX4233EEH/FJX4333E(EH)/FJX7333IHP/FJX7337IHP/FJX7457IHP** Príležitostne očistíte displej skrinky rozvádžania vzduchu s jemným roztokom teplej mydlovej vody. Obrazovka displeja je z akrylového skla a niektoré bežné domáce chemické prostriedky, ako napríklad chemické čističe, čističe na okná, alkohol, konkrétne tenzidy, organické rozpúšťadlá a zmäkčovadlá ju môžu poškodiť.

## 11 Údržba

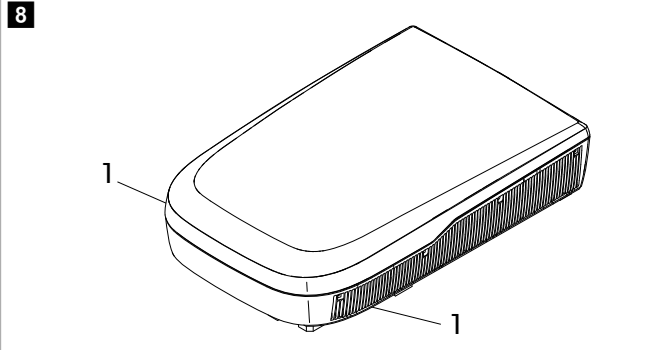
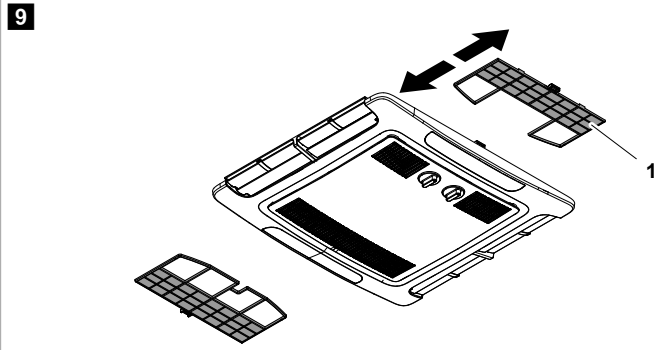

**VÝSTRAHA! Nebezpečenstvo poranenia** Iné údržbárske práce, okrem prác, ktoré sú tu uvedené, smie vykonávať iba kvalifikovaný personál, ktorý je oboznámený s rizikami spojenými s manipuláciou s chladiacimi prostriedkami a systémami klimatizácie, a tiež s príslušnými predpismi.

Interval	Kontrola/údržba
Pravidelne	<p data-bbox="333 188 1003 231">Skontrolujte, či odtokové kanály kondenzovanej vody (<b>1</b>) na bočných stranách strešnej klimatizácie sú čisté a kondenzovaná voda môže odtekať.</p> <div data-bbox="333 247 1016 616"> <p data-bbox="344 252 367 284"><b>8</b></p>  </div>
Pravidelne (Freshjet FJX4233M)	<p data-bbox="333 643 647 667">Vyčistite filter jednotky vypúšťania vzduchu.</p> <div data-bbox="333 683 1016 1045"> <p data-bbox="344 687 367 719"><b>9</b></p>  </div> <ol data-bbox="347 1061 817 1125" style="list-style-type: none"> <li>1. Vyberte filter (<b>1</b>).</li> <li>2. Vyčistite filter (<b>1</b>) s čistiacim roztokom a nechajte ich vyschnúť.</li> <li>3. Suchý filter (<b>1</b>) vložte naspäť.</li> </ol>



Interval	Kontrola/údržba
Pravidelne (Freshjet FJX4233EEH/FJX4333E(E- H)/FJX7333IHP/ FJX7337IHP/FJX7457IHP)	<ul style="list-style-type: none"> <li>• Vyčistíte filter jednotky vypúšťania vzduchu.</li> </ul> <div data-bbox="367 225 1016 528" style="border: 1px solid black; padding: 10px; margin: 10px 0;"> </div> <ol style="list-style-type: none"> <li>1. Zasuňte plochý skrutkovač alebo nôž do rukoväti (1), aby ste jemne vypáčili filtre (2).</li> <li>2. Filtre vyťahnite rukou.</li> <li>3. Vyčistíte filtre s čistiacim roztokom a nechajte ich vyschnúť.</li> <li>4. Suché filtre zasuňte naspäť. obr. 10 na strane 377</li> </ol> <ul style="list-style-type: none"> <li>• Údržbu a servis výmenníka tepla strešnej klimatizácie prenechajte odbornej firme.</li> </ul>
Jedenkrát ročne	<ul style="list-style-type: none"> <li>• Skontrolujte, či tesnenie medzi strešnou klimatizáciou a strechou vozidla nevykazuje trhliny alebo iné poškodenie.</li> <li>• Skontrolujte, či upevňovacie skrutky sú utiahnuté správnym ťahovacím momentom (2,5 Nm ± 0,3 Nm) a v prípade potreby ich utiahnite.</li> </ul>

## 12 Odstraňovanie porúch

Porucha	Možná príčina	Návrh riešenia
Klimatizácia slabó chladí	Strešná klimatizácia nie je nastavená na chladenie.	Nastavte strešnú klimatizáciu na chladenie.
	Teplota okolia je vyššia ako 52 °C.	Strešná klimatizácia je navrhnutá len pre teplotu okolia do 52 °C.
	Nastavená teplota je vyššia ako vnútorná teplota.	Zvoľte nižšiu teplotu.
	Teplota okolia je nižšia ako 16 °C.	Strešná klimatizácia je navrhnutá na chladenie iba pri teplote okolia nad 16 °C.
	Jeden zo snímačov teploty je chybný.	Kontaktujte autorizovaného servisného technika alebo spoločnosť Dometic.
	Ventilátor odparovača je poškodený.	Kontaktujte autorizovaného servisného technika alebo spoločnosť Dometic.
	Ventilátor kondenzátora je poškodený.	Kontaktujte autorizovaného servisného technika alebo spoločnosť Dometic.

Porucha	Možná príčina	Návrh riešenia
<b>Iba FreshJet FJX4233EEH/ FJX4333E(EH)/FJX7333IHP/ FJX7337IHP/FJX7457IHP:</b> Klimatizácia slabo vyhrieva	Strešná klimatizácia nie je nastavená na vyhrievanie.	Nastavte strešnú klimatizáciu na vyhrievanie.
	Teplota okolia je nižšia ako $- 2\text{ }^{\circ}\text{C}$ .	Strešná klimatizácia je navrhnutá pre teplotu okolia nad $- 2\text{ }^{\circ}\text{C}$ .
	Nastavená teplota je nižšia ako vnútorná teplota.	Zvoľte vyššiu teplotu.
	Jeden zo snímačov teploty je chybný.	Kontaktujte autorizovaného servisného technika alebo spoločnosť Dometic.
	Ventilátor odparovača je poškodený.	Kontaktujte autorizovaného servisného technika alebo spoločnosť Dometic.
Malý výstup vzduchu	Otvory prívodu vzduchu sú blokované alebo zakryté.	Odstraňte lístie a iné nečistoty z vetracích mriežok strešnej klimatizácie.
	Ventilátor je chybný.	Kontaktujte autorizovaného servisného technika alebo spoločnosť Dometic.
Vnikanie vody do vozidla.	Odtokové otvory pre kondenzovanú vodu sú upchaté.	Vyčistite odtokové otvory pre kondenzovanú vodu.
	Tesnenia sú poškodené.	Kontaktujte autorizovaného servisného technika alebo spoločnosť Dometic.
Strešná klimatizácia sa nezapne.	Nie je pripojený žiadny zdroj napájania.	Skontrolujte zdroj napájania.
	Napätie je príliš nízke ( $< 200\text{ V}$ ).	Kontaktujte autorizovaného servisného technika alebo spoločnosť Dometic.
	Menič napätia je chybný.	Kontaktujte autorizovaného servisného technika alebo spoločnosť Dometic.
	Jeden zo snímačov teploty je chybný.	Kontaktujte autorizovaného servisného technika alebo spoločnosť Dometic.
	Elektrická poistka zdroja napájania má príliš nízku intenzitu.	Kontaktujte autorizovaného servisného technika alebo spoločnosť Dometic.
Strešná klimatizácia sa nezapne.	Jeden zo snímačov teploty je chybný.	Kontaktujte autorizovaného servisného technika alebo spoločnosť Dometic.
	Elektrická poistka zdroja napájania má príliš nízku intenzitu.	Kontaktujte autorizovaného servisného technika alebo spoločnosť Dometic.
<b>Iba FreshJet FJX4233EEH/ FJX4333E(EH)/FJX7333IHP/ FJX7337IHP/FJX7457IHP:</b> Strešná klimatizácia sa neustále samočinne vypína.	Snímač námrazy sa zopol.	Vonkajšia teplota je príliš nízka alebo všetky vzduchové dýzy sú zatvorené.
Displej zobrazuje: PO	Nadmerná teplota alebo nadprúd na IPM module	Kontaktujte autorizovaného servisného technika alebo spoločnosť Dometic.

Porucha	Možná príčina	Návrh riešenia
Displej zobrazuje: P1	Podpäťová poistka	Kontaktujte autorizovaného servisného technika alebo spoločnosť Dometic.
Displej zobrazuje: P2	Nadprúdová ochrana klimatizačnej jednotky	Kontaktujte autorizovaného servisného technika alebo spoločnosť Dometic.
Displej zobrazuje: P4	Ochrana vypúšťacej rúry pred vysokými teplotami	Kontaktujte autorizovaného servisného technika alebo spoločnosť Dometic.
Displej zobrazuje: P5	Ochrana cievky výparníka (režim Chladenie)	Kontaktujte autorizovaného servisného technika alebo spoločnosť Dometic.
Displej zobrazuje: P6	Ochrana cievky kondenzátora (režim Chladenie)	Kontaktujte autorizovaného servisného technika alebo spoločnosť Dometic.
Displej zobrazuje: P7	Ochrana cievky výparníka (režim Kúrenia)	Kontaktujte autorizovaného servisného technika alebo spoločnosť Dometic.
Displej zobrazuje: P9	Abnormálny chod kompresora alebo sa kompresor nespustí	Kontaktujte autorizovaného servisného technika alebo spoločnosť Dometic.
Displej zobrazuje: E0	Chyba komunikácie	Kontaktujte autorizovaného servisného technika alebo spoločnosť Dometic.
Displej zobrazuje: E1	Porucha snímača teploty v interiéri	Kontaktujte autorizovaného servisného technika alebo spoločnosť Dometic.
Displej zobrazuje: E2	Chyba snímača teploty cievky výparníka	Kontaktujte autorizovaného servisného technika alebo spoločnosť Dometic.
Displej zobrazuje: E3	Chyba snímača teploty cievky kondenzátora	Kontaktujte autorizovaného servisného technika alebo spoločnosť Dometic.
Displej zobrazuje: E7	Chyba snímača vonkajšej teploty	Kontaktujte autorizovaného servisného technika alebo spoločnosť Dometic.
Displej zobrazuje: E8	Chyba snímača teploty vypúšťacej rúry	Kontaktujte autorizovaného servisného technika alebo spoločnosť Dometic.
Displej zobrazuje: E9	Chyba pohonu kompresora alebo IPM modulu	Kontaktujte autorizovaného servisného technika alebo spoločnosť Dometic.
Displej zobrazuje: EA	Chyba snímača prúdu	Kontaktujte autorizovaného servisného technika alebo spoločnosť Dometic.
Displej zobrazuje: EE	Chyba Outdoor EEPROM	Kontaktujte autorizovaného servisného technika alebo spoločnosť Dometic.
Displej zobrazuje: EL	Chyba komunikácie LIN-BUS/CI-BUS	Kontaktujte autorizovaného servisného technika alebo spoločnosť Dometic.

## 13 Likvidácia



Obalový materiál dávajte podľa možnosti do príslušného recyklovateľného odpadu. Informujte sa v najbližšom recyklačnom stredisku alebo u vášho špecializovaného predajcu o likvidácii výrobku v súlade s príslušnými predpismi týkajúcimi sa likvidácie.



Chráňte životné prostredie! Akumulátory a batérie nepatria do domového odpadu. Vaše poškodené akumulátory alebo prázdne batérie odovzdajte u predajcu alebo v zbernom mieste.

## 14 Záruka

Platí zákonom stanovená záručná lehota. Ak je výrobok poškodený, obráťte sa na pobočku výrobcu vo vašej krajine (pozri [dometic.com/dealer](http://dometic.com/dealer)) alebo na vášho výrobcu.

Ak žiadate o vybavenie opravy alebo nárokov vyplývajúcich zo záruky, musíte priložiť nasledovné podklady:

- kópiu faktúry s dátumom kúpy,
- dôvod reklamácie alebo opis chyby.

Upozorňujeme Vás, že samooprava alebo neodborná oprava môže mať za následok ohrozenie bezpečnosti a zánik záruky.

## 15 Technické údaje

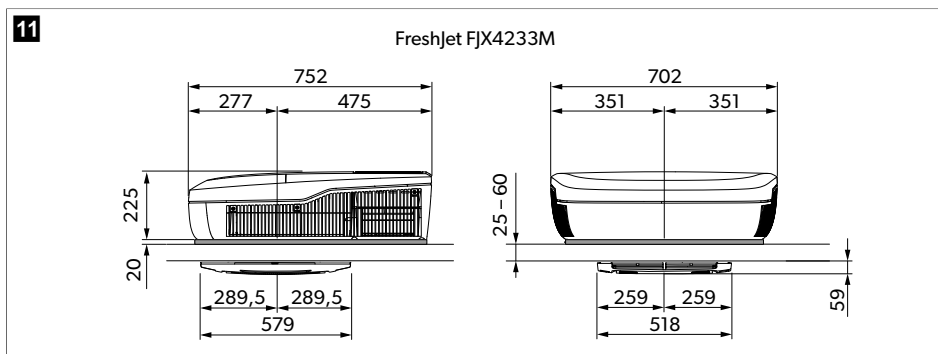

12

FJX4233EEH, FJX4333E(EH), FJX7333IHP

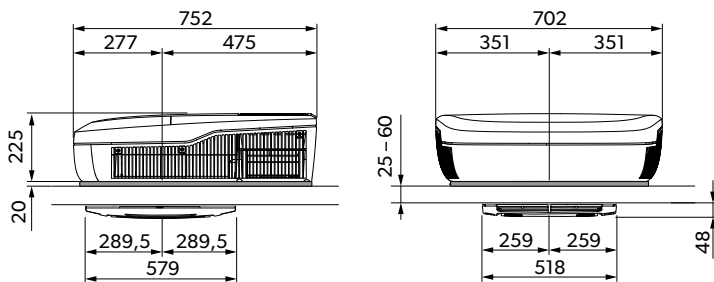

13

FreshJet FJX7337IHP

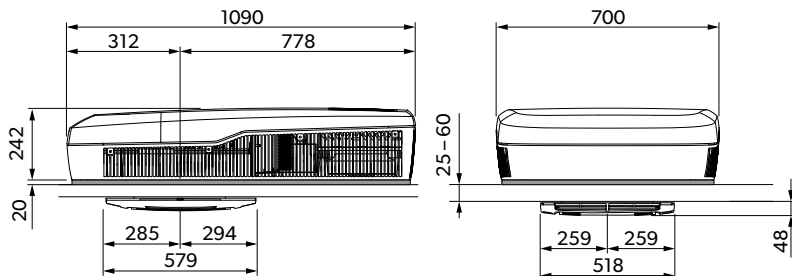

14

FreshJet FJX7457IHP

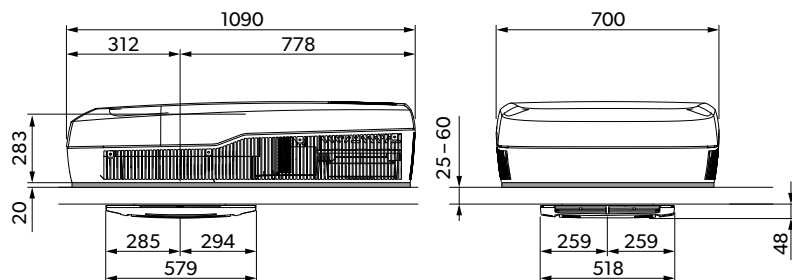

Obsahuje fluórované skleníkové plyny. Hermeticky uzatvorené zariadenie.

	<b>FreshJet FJX4233M</b>
Chladiaci výkon v nadväznosti na ISO 5151:	1500 W
Vstupné striedavé napätie:	220 V ... 240 V / 50 Hz

	<b>FreshJet FJX4233M</b>
Menovitý prúd chladenia:	< 3.3 A
Potrebné poisťka:	4 A
Rozsah prevádzkovej teploty:	- 2 °C ... 52 °C
Chladiaci prostriedok:	R410a
Množstvo chladiaceho prostriedku:	380 g
Ekvivalent CO <sub>2</sub> :	0.793 t
Potenciál globálneho otepľovania (GWP):	2088
Trieda ochrany (strešná jednotka):	IPX4
Hladina hluku (maximálne otáčky ventilátora)	< 70 dB(A)
Odporúčaná max. dĺžka vozidla (s izolovanými stenami):	< 5 m
Rozmery DxŠxV:	obr. 11 na strane 380
Hmotnosť:	< 30 kg
Skúška/certifikát:	

	<b>FreshJet FJX4233EEH</b>	<b>FreshJet FJX4333EEH</b>	<b>FreshJet FJX4333E</b>
Chladiaci výkon v nadväznosti na ISO 5151:	1700 W	2200 W	2200 W
Vyhrievací výkon v nadväznosti na ISO 5151:	800 W	1000 W	-
Vstupné striedavé napätie:	220 V ... 240 V / 50 Hz		
Menovitý prúd chladenia:	3.6 A	4.8 A	4.8 A
Menovitý prúd vyhrievania:	< 5.2 A	< 5.2 A	-
Potrebné poisťka:	4 A	5 A	6 A
Rozsah prevádzkovej teploty:	- 2 °C ... 52 °C		
Chladiaci prostriedok:	R32		

	<b>FreshJet FJX4233EEH</b>	<b>FreshJet FJX4333EEH</b>	<b>FreshJet FJX4333E</b>
Množstvo chladiaceho prostriedku:	320 g	360 g	360 g
Ekvivalent CO <sub>2</sub> :	0.216 t	0.243 t	0.243 t
Potenciál globálneho otepľovania (GWP):	675		
Trieda ochrany (strešná jednotka):	IPX4		
Hladina hluku (maximálne otáčky ventilátora)	< 70 dB(A)		
Odporúčaná max. dĺžka vozidla (s izolovanými stenami):	< 6 m	< 7 m	< 7 m
Rozmery DxŠxV:	obr. 12 na strane 381		
Hmotnosť:	< 30 kg	< 30 kg	< 30 kg
Skúška/certifikát:			

	<b>FreshJet FJX7333IHP</b>	<b>FreshJet FJX7337IHP</b>	<b>FreshJet FJX7457IHP</b>
Chladiaci výkon v nadväznosti na ISO 5151:	2200 W	3000 W	3500 W
Vyhrievací výkon v nadväznosti na ISO 5151:	2000 W	2500 W	3000 W
Vstupné striedavé napätie:	220 V ... 240 V / 50 Hz ... 60 Hz	220 V ... 240 V / 50 Hz ... 60 Hz	220 V ... 240 V / 50 Hz ... 60 Hz
Menovitý prúd chladenia:	< 7.5 A	< 7.5 A	< 7.5 A
Menovitý prúd vyhrievania:	< 6.1 A	< 6.1 A	< 6.1 A
Potrebné poisťka:	6 A	6 A	6 A
Rozsah prevádzkovej teploty:	- 2 °C ... 52 °C	- 2 °C ... 52 °C	- 2 °C ... 52 °C
Chladiaci prostriedok:	R32	R32	R32
Množstvo chladiaceho prostriedku:	420 g	480 g	650 g
Ekvivalent CO <sub>2</sub> :	0.2835 t	0.3240 t	0.43875 t
Potenciál globálneho otepľovania (GWP):	675		

	<b>FreshJet FJX7333IHP</b>	<b>FreshJet FJX7337IHP</b>	<b>FreshJet FJX7457IHP</b>
Trieda ochrany (strešná jednotka):	IPX4		
Hladina hluku (maximálne otáčky ventilátora)	< 70 dB(A)		
Odporúčaná max. dĺžka vozidla (s izolovanými stenami):	< 7 m	< 7 m	> 8 m
Rozmery DxŠxV:	obr. <b>12</b> na strane 381	obr. <b>13</b> na strane 381	obr. <b>14</b> na strane 381
Hmotnosť:	< 30 kg	< 35 kg	< 40 kg
Skúška/certifikát:			



## Czech

1	Important notes.....	385
2	Vysvětlení symbolů.....	385
3	Bezpečnostní pokyny.....	386
4	Použití v souladu s účelem.....	387
5	Vysvětlení symbolů na spotřebiči.....	387
6	Technická omezení a podmínky.....	388
7	Technický popis.....	388
8	Před prvním použitím.....	394
9	Obsluha.....	394
10	Čištění střešní klimatizace.....	402
11	Údržba.....	402
12	Odstraňování poruch a závad.....	404
13	Likvidace.....	407
14	Záruka.....	407
15	Technické údaje.....	407

## 1 Important notes

Pečlivě si prosím přečtěte a dodržujte všechny pokyny, směrnice a varování obsažené v tomto návodu k výrobku, abyste měli jistotu, že výrobek budete vždy správně instalovat, používat a udržívat. Tyto pokyny MUSÍ být uschovány v blízkosti výrobku.

Používáním výrobku tímto potvrzujete, že jste si pečlivě přečetli všechny pokyny, směrnice a varování a že rozumíte podmínkám uvedeným v tomto dokumentu a souhlasíte s nimi. Souhlasíte s používáním tohoto výrobku pouze k určenému účelu a použití a v souladu s pokyny, směrnicemi a varováními uvedenými v tomto návodu k výrobku a v souladu se všemi příslušnými zákony a předpisy. Pokud si nepřetčete a nebudete dodržovat zde uvedené pokyny a varování, může to vést ke zranění vás i ostatních, poškození vašeho výrobku nebo poškození jiného majetku v okolí. Tento návod k výrobku, včetně pokynů, směrnic a varování a související dokumentace může být předmětem změn a aktualizací. Aktuální informace o výrobku naleznete na [documents.dometic.com](http://documents.dometic.com).

## 2 Vysvětlení symbolů



**NEBEZPEČÍ!** Označuje nebezpečnou situaci, která, pokud se jí nezabrání, bude mít za následek smrt nebo vážné zranění.



**VÝSTRAHA!** Označuje nebezpečnou situaci, která, pokud se jí nezabrání, bude mít za následek smrt nebo vážné zranění.



**UPOZORNĚNÍ!** Označuje nebezpečnou situaci, která, pokud se jí nezabrání, může mít za následek lehké nebo středně těžké zranění.



**POZOR!** Označuje nebezpečnou situaci, která, pokud se jí nezabrání, může mít za následek lehké nebo středně těžké zranění.



**Poznámka** Doplnující informace týkající se obsluhy výrobku.

### 3 Bezpečnostní pokyny



**VÝSTRAHA! Nedodržení těchto varování by mohlo mít za následek smrt nebo vážné zranění.**

- **Elektrické přístroje nejsou hračky pro děti!** Tento přístroj není určen k používání osobami (včetně dětí) s omezenými fyzickými, senzoryckými nebo duševními schopnostmi nebo osobami s nedostatkem zkušeností a vědomostí, ledaže jsou pod dozorem nebo byly poučeny.
- Děti by měly být pod dohledem tak, aby si s přístrojem nehrály.
- Tento přístroj mohou používat děti od 8 let a osoby se sníženými fyzickými, smyslovými nebo duševními schopnostmi nebo s nedostatečnými zkušenostmi a znalostmi, pokud jsou pod dohledem nebo obdržely pokyny týkající se používání přístroje bezpečným způsobem a porozuměly souvisejícím nebezpečím.
- Čištění nesmějí provádět děti bez dozoru.
- Každá osoba, která se podílí na práci s chladivem nebo na okruhu chladiva, by měla být držitelem aktuálního platného osvědčení od akreditovaného hodnotícího subjektu v oboru, které osvědčuje její způsobilost k bezpečnému zacházení s chladivem v souladu s uznávanou specifikací hodnocení v oboru.
- Údržba se smí provádět pouze podle doporučení výrobce zařízení. Údržba a opravy, které vyžadují pomoc jiných kvalifikovaných pracovníků, musí být prováděny pod dohledem osoby způsobilé k používání hořlavých chladiv.
- Opravy přístroje smějí provádět pouze odborníci, kteří jsou seznámeni s hrozícími nebezpečími a s příslušnými předpisy. Nesprávně provedené opravy mohou být zdrojem značných rizik. Za účelem opravy se obraťte na servisní středisko ve vaší zemi (viz [dometic.com/dealer](http://dometic.com/dealer)).
- Při práci na přístroji vždy přerušete napájení elektrickým proudem.
- Přístroj je třeba skladovat v místnosti, kde trvale nepůsobí zdroje vznícení, jako např. otevřené plameny, zapnutý plynový spotřebič nebo elektrický ohřívač.
- Přístroj se nesmí propichovat ani spalovat.
- Dbejte na to, že chladiva mohou být bez zápachu.
- Přístroj nepoužívejte v blízkosti hořlavých kapalin nebo v uzavřených prostorách.
- Dbejte na to, že v oblasti výstupu vzduchu nesmějí být uloženy ani namontovány žádné hořlavé předměty. Je nutné dodržet vzdálenost minimálně 50 cm.
- Ventilační otvory nesmí obsahovat žádné překážky.
- Okruh chladiva se nesmí poškodit.
- Při vyhledávání nebo zjišťování úniku chladiva se v žádném případě nesmí používat potenciální zdroje vznícení. Nesmí se používat halogenidový hořák (ani žádný jiný detektor využívající otevřený plamen).
- Střešní klimatizace se musí instalovat ve vozidle s podlahovou plochou větší než 4 m<sup>2</sup>.



### UPOZORNĚNÍ! Nedodržení těchto upozornění by mohlo mít za následek lehké nebo střední zranění.

- Nesahejte do otvorů pro výstup vzduchu a nezavádějte do přístroje cizí předměty.
- V případě požáru neotevírejte horní skořepinu přístroje. Místo toho použijte schválené hasicí prostředky. Oheň nehaste vodou.
- Pokud je napájecí kabel poškozen, musí být vyměněn výrobcem, jeho servisním zástupcem nebo podobně kvalifikovanými osobami, aby nedošlo k nebezpečí.
- V případě, že přístroj obsahuje ionizátor, poraďte se před jeho použitím v případě zdravotních potíží se svým lékařem. Ionizátor může v malém množství produkovat ozón (O3). Pokud trpíte plicním onemocněním, astmatem, srdečním onemocněním, dýchacími potížemi nebo máte citlivost na ozon, poraďte se s lékařem, zda je pro vás používání tohoto přístroje bezpečné.



### POZOR! Nebezpečí poškození

- K urychlení rozmrazování nebo čištění nepoužívejte jiné než výrobcem doporučené prostředky.
- Přístroj musí být skladován tak, aby nedošlo k jeho mechanickému poškození.
- Neprovádějte žádné úpravy nebo změny přístroje!
- Při instalovaném přístroji nesmíte v žádném případě mýt vozidlo v myčce.
- Dojde-li v okruhu chladiva k závadě, přístroj musí být zkontrolován a opraven výrobcem, jeho zástupcem servisu nebo podobně kvalifikovanými osobami, aby nedošlo k nebezpečí.

## 4 Použití v souladu s účelem

Střešní klimatizace FreshJet FJX je určena pouze k montáži na střechu karavanu nebo rekreačního vozidla za účelem chlazení.

Střešní klimatizace **není** určena pro vlaky, domy a byty. Střešní klimatizace **není** určena k montáži do stavebních, zemědělských nebo jiných pracovních strojů.

Tento výrobek je vhodný pouze k určenému účelu a použití v souladu s tímto návodem.

Tento návod poskytuje informace, které jsou nezbytné pro řádnou instalaci a/nebo provoz výrobku. Nedostatečná instalace a/nebo nesprávný provoz či údržba povedou k neuspokojivému výkonu a možné závadě.

Výrobce nepřijímá žádnou odpovědnost za jakékoli zranění nebo poškození výrobku vyplývající z následujícího:

- Nesprávné sestavení nebo připojení včetně nadměrného napětí
- Nesprávná údržba nebo použití jiných náhradních dílů než původních dílů dodaných výrobcem
- Změna výrobku bez výslovného souhlasu výrobce
- Použití k jiným účelům, než jsou popsány v tomto návodu

Společnost Dometic si vyhrazuje právo změnit vzhled a specifikace výrobku.

## 5 Vysvětlení symbolů na spotřebiči



Výstraha! Materiál s nízkou rychlostí hoření.



Přečtěte si návod k obsluze.



Přečtěte si servisní příručku.

## 6 Technická omezení a podmínky

Střešní klimatizace je určena pro vozidla se střechami o tloušťce 25 mm ... 60 mm. Funkce střešní klimatizace je zaručena pro okolní teploty v rozmezí  $-2\text{ }^{\circ}\text{C}$  ...  $52\text{ }^{\circ}\text{C}$ . Střešní klimatizace je určena k montáži v rozmezí  $\pm 10\text{ }^{\circ}$  od vodorovné roviny. Výkon střešní klimatizace se může snížit, pokud je vystavena silným vibracím, například způsobeným špatným stavem vozovky.

## 7 Technický popis

Střešní klimatizace FreshJet FJX4233M dodává interiéru vozidla chladný vzduch, který je bez prachu a nečistot a může být odvlhčován.

Střešní klimatizace FreshJet FJX4233EEH/FJX4333E(EH)/FJX7333IHP/FJX7337IHP/FJX7457IHP dodává interiéru chladný nebo teplý vzduch, který je bez prachu a nečistot a může být odvlhčován.

Střešní klimatizace může snížit teplotu uvnitř vozidla až na určitou stanovenou hodnotu, která závisí na typu vozidla, na okolní teplotě a na chladicím výkonu střešní klimatizace. Pod venkovní teplotou  $16\text{ }^{\circ}\text{C}$  se střešní klimatizace již neochlazuje.

Střešní klimatizace se ovládá následujícími ovládacími prvky:

- Ovládací panel

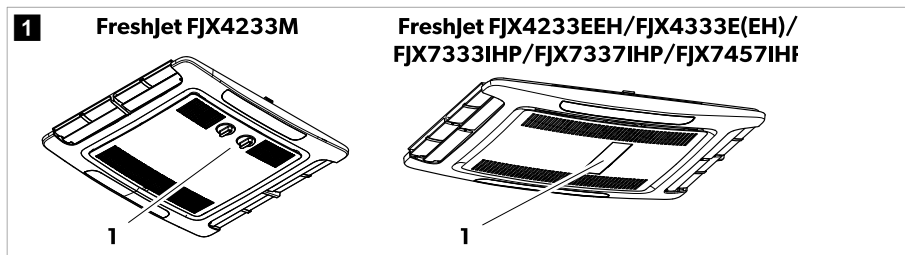

- Dálkový ovladač (pouze FJX4233EEH/FJX4333E(EH)/FJX7333IHP/FJX7337IHP/FJX7457IHP)

### 7.1 Seznam modelů

V následující tabulce je uvedeno, která funkce se vztahuje na konkrétní model:

- Funkce je k dispozici

○ Funkci je možné doplnit

	FJX4233M	FJX4233EEH	FJX4333EEH	FJX4333E	FJX7333IHP	FJX7337IHP	FJX7457IHP
Automatický		●	●	●	●	●	●
Chlazení	●	●	●	●	●	●	●
Ohřev		●	●	○	●	●	●
Větrání	●	●	●	●	●	●	●
Odvlhčování		●	●	●	●	●	●
Čistička vzduchu	○	●	●	○	●	●	●
ADB svítidlo		●	●	○	●	●	●
Externí svítidlo					●	●	●
Časovač		●	●	●	●	●	●
Spánek		●	●	●	●	●	●
Soft Start			●	○	●	●	●

## 7.2 Ovládací panel FreshJet FJX4233M

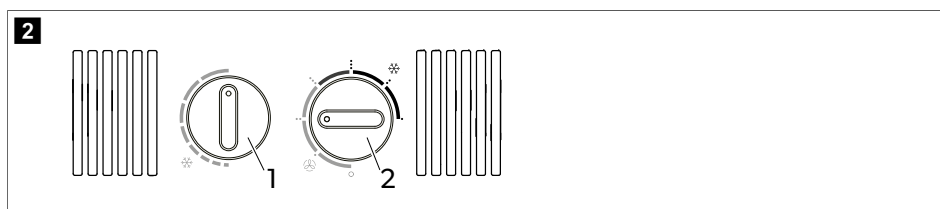

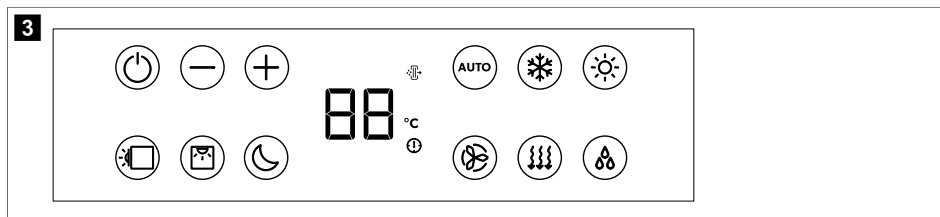

Knoflík	Popis
	Výběr teploty. Otáčením ve směru hodinových ručiček dosáhnete vyššího chlazení.
	Zapnutí nebo vypnutí střešní klimatizace a výběr intenzity cirkulace vzduchu v režimu Větrání (🌀) nebo intenzity chlazení v režimu Chlazení (❄️).

### 7.3 Ovládací panel FreshJet FJX4233EEH/FJX4333E(EH)/FJX7333IHP/ FJX7337IHP/FJX7457IHP



















Symbol	Popis
	Zapnutí nebo přepnutí střešní klimatizace do pohotovostního režimu.
	Zvýšení aktuálně zobrazené hodnoty.
	Snížení aktuálně zobrazené hodnoty.
	Spárování s bluetooth/WLAN při současném stisknutí obou tlačítek.
	Zapnutí nebo vypnutí okolních světel ve střešní jednotce.
	Zapnutí nebo vypnutí okolních světel v rozvaděči vzduchu.
	Aktivace funkce spánku (Doplňkové funkce (pouze FJX4233EEH/FJX4333E(EH)/FJX7333IHP/FJX7337IHP/ FJX7457IHP) na stránce 393).
	Zobrazuje nastavenou teplotu a při nastavování ventilátoru zobrazuje úroveň ventilátoru.
	Signalizuje, že je aktivní režim AirPurifier.
	Signalizuje, že teplota je zobrazena ve stupních Celsia.
	Signalizuje, že je nastaven časovač.
	Aktivace/deaktivace automatického režimu (Režimy klimatizace (pouze FJX4233EEH/FJX4333E(EH)/ FJX7333IHP/FJX7337IHP/FJX7457IHP) na stránce 393).
	Aktivace/deaktivace režimu chlazení (Režimy klimatizace (pouze FJX4233EEH/FJX4333E(EH)/FJX7333IHP/ FJX7337IHP/FJX7457IHP) na stránce 393).
	Aktivace/deaktivace režimu topení (Režimy klimatizace (pouze FJX4233EEH/FJX4333E(EH)/FJX7333IHP/ FJX7337IHP/FJX7457IHP) na stránce 393).
	Upravuje otáčky ventilátoru na nízké, střední, vysoké, turbo nebo automatické (na displeji rozvaděče vzduchu se po změně krátce zobrazí jako 1, 2, 3, 4 nebo AA).

Symbol	Popis
	Aktivace/deaktivace režimu větrání (Režimy klimatizace (pouze FJX4233EEH/FJX4333E(EH)/FJX7333IHP/FJX7337IHP/FJX7457IHP) na stránce 393). Cirkuluje vzduch bez topení nebo chlazení.
	Aktivace/deaktivace režimu odvlhčování (Režimy klimatizace (pouze FJX4233EEH/FJX4333E(EH)/FJX7333IHP/FJX7337IHP/FJX7457IHP) na stránce 393).

## 7.4 Dálkový ovladač FreshJet FJX4233EEH/FJX4333E(EH)/FJX7333IHP/FJX7337IHP/FJX7457IHP





Ovládací a indikační prvky obr. **4** na stránce 391:

Tlačítko	Popis
—	<p><b>Displej</b></p> <p>Zobrazuje následující:</p> <ul style="list-style-type: none"> <li>• Čas</li> <li>• Zvolená teplota v místnosti (cílová hodnota) ve °C</li> <li>• Skutečná teplota v prostoru</li> <li>• Režim klimatizace</li> <li>• Rychlost ventilátoru</li> <li>• Symboly pro aktivní doplňkové funkce</li> <li>• Stav baterie</li> </ul>
	Zapnutí nebo přepnutí střešní klimatizace do pohotovostního režimu.
	Zvýšení aktuálně zobrazené hodnoty.
	Snížení aktuálně zobrazené hodnoty.
	Výběr otáček ventilátoru (Ruční výběr otáček ventilátoru na stránce 397).
	Výběr režimu klimatizace (Režimy klimatizace (pouze FJX4233EEH/FJX4333E(EH)/FJX7333IHP/FJX7337IHP/FJX7457IHP) na stránce 393). Zobrazí se odpovídající symbol.
	Aktivace funkce spánku (Doplňkové funkce (pouze FJX4233EEH/FJX4333E(EH)/FJX7333IHP/FJX7337IHP/FJX7457IHP) na stránce 393). Zobrazí se symbol  .
	Potvrzení a uložení nastavení.
	Nastavení časovače a hodin.
	Zapnutí nebo vypnutí okolních světel v rozvaděči vzduchu.
	Jedním stisknutím zobrazíte aktuální vnitřní teplotu. Zobrazí se symbol  . Stisknutím dvakrát se zobrazí nastavená teplota.
	Aktivace funkce „I feel“. Zobrazí se symbol  . Každých 10 min funkce „I feel“ upravuje cílovou teplotu podle skutečné teploty, kterou naměří dálkový ovladač.
	Zapnutí nebo vypnutí okolních světel ve střešní jednotce.
	Zobrazuje, že baterie v dálkovém ovladači jsou vybité. Vyměňte baterie (Výměna baterií dálkového ovladače na stránce 400).
	Zobrazuje, že dálkový ovladač přenáší hodnoty do střešní klimatizace.







## 7.5 Režimy klimatizace (pouze FJX4233M)

Střešní klimatizace má následující režimy klimatizace:

Režim klimatizace	Symbol na displeji	Popis
Chlazení		Zadáte nastavení teploty a ventilátoru a střešní klimatizace zchladí interiér na tuto teplotu.
Větrání		Zadáte nastavení ventilátoru a střešní klimatizace cirkuluje vzduch bez topení nebo chlazení.





## 7.6 Režimy klimatizace (pouze FJX4233EEH/FJX4333E(EH)/FJX7333IHP/FJX7337IHP/FJX7457IHP)

Střešní klimatizace má následující režimy klimatizace:

Režim klimatizace	Symbol na displeji	Popis
Automatický	<b>A</b>	Zadáte teplotu a střešní klimatizace uvede interiér na tuto teplotu topením nebo chlazením a regulací potřebných otáček ventilátoru.
Chlazení		Zadáte nastavení teploty a ventilátoru a střešní klimatizace zchladí interiér na tuto teplotu.
Ohřev		<b>Ne FJX4333E:</b> Zadáte nastavení teploty a ventilátoru a střešní klimatizace vytopí interiér na tuto teplotu. Ventilátor se spustí až po 2 min (při nízkých otáčkách) a poté asi po 5 min přejde na nastavené otáčky ventilátoru (po dosažení teploty výparníku).
Větrání		Zadáte nastavení ventilátoru a střešní klimatizace cirkuluje vzduch bez topení nebo chlazení.
Vysoušení vzduchu		Střešní klimatizace odstraní vlhkost ze vzduchu bez topení nebo chlazení vnitřku a tím sníží relativní vlhkost vzduchu.
Čistička vzduchu		<b>Ne FJX4333E:</b> Střešní klimatizace ionizuje vzduch, čímž ze vzduchu zachycuje prach a částice včetně virů a bakterií.

## 7.7 Doplnkové funkce (pouze FJX4233EEH/FJX4333E(EH)/FJX7333IHP/FJX7337IHP/FJX7457IHP)

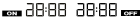
Střešní klimatizace má následující doplňkové funkce:

Doplňková funkce	Hlášení na displeji	Popis
Časovač		Střešní klimatizace je zapnuta v nastavenou dobu.
		Střešní klimatizace je vypnuta v nastavenou dobu.
		Střešní klimatizace je v nastavených dobách zapnuta a opět vypnuta.
Spánek		Funkce spánku snižuje otáčky ventilátoru a otáčky kompresoru, aby se snížila hladina hluku pro pohodlný spánek.
I Feel		Dálkové ovládání měří teplotu v místnosti a tuto naměřenou hodnotu přenáší do střešní klimatizace každých 10 min. Střešní klimatizace tomuto měření přizpůsobí cílovou hodnotu.
Soft Start		<b>Ne FJX4233EEH:</b> Špičkový proud, který kompresor vytváří při spuštění, je snížen funkcí měkkého startu. Pokud je jako zdroj energie použit generátor, nedojde k jeho přetížení.

## 8 Před prvním použitím

### Kontroly před uvedením do provozu

Před zapnutím střešní klimatizace dodržujte následující pokyny:

1. Zkontrolujte, zda napájecí napětí a frekvence odpovídají hodnotám uvedeným v Technické údaje na stránce 407.
2. Zajistěte, aby otvory k sání vzduchu i výduchy vzduchu zůstaly vždy volné. Všechny ventilační mřížky musí být vždy volně přístupné, aby bylo zajištěno, že střešní klimatizace bude schopna pracovat na maximální výkon.

**Připravte dálkový ovladač (pouze FreshJet FJX4233EEH/FJX4333E(EH)/FJX7333IHP/FJX7337IHP/FJX7457IHP).**

3. Vložte baterie (Výměna baterií dálkového ovladače na stránce 400).

**Nastavte čas (pouze FreshJet FJX4233EEH/FJX4333E(EH)/FJX7333IHP/FJX7337IHP/FJX7457IHP).**

4. Nastavte aktuální čas (Nastavení aktuálního času na stránce 397).

## 9 Obsluha

### 9.1 Rady ke snadnějšímu použití

S využitím následujících rad lze optimalizovat výkon vaší střešní klimatizace:

- Zlepšete tepelnou izolaci vozidla utěsněním spár a oken reflexními roletami nebo závěsy.
- Nastavte přiměřené teploty a výkony ventilátoru.
- Rozumně vyrovnejte výdechy vzduchu.
- Ujistěte se, že výdechy vzduchu a otvory sání nejsou zakryté ručníky, papírem ani jinými předměty.

- **Pouze FreshJet FJX4233EEH/FJX4333E(EH)/FJX7333IHP/FJX7337IHP/FJX7457IHP:** Pokud bylo vozidlo dlouhodobě vystaveno přímému slunečnímu světlu: Střešní klimatizaci provozujte chvíli v režimu Větrání (🌀) s otevřenými okny a poté zapněte režim Chlazení (❄️).
- **Pouze FreshJet FJX4233EEH/FJX4333E(EH)/FJX7333IHP/FJX7337IHP/FJX7457IHP:** V režimu Chlazení (❄️) pokud možno neotevírejte dveře a okna.

## 9.2 Důležité pokyny k obsluze

Střešní klimatizace FreshJet FJX4233M pracuje ve třech provozních režimech:

Provozní režim	Popis
Vypnuto	Střešní klimatizace je vypnutá.
Chlazení	Střešní klimatizace ochlazuje interiér.
Větrání	Střešní klimatizace cirkuluje vzduch bez chlazení.

Střešní klimatizace FreshJet FJX4233EEH/FJX4333E(EH)/FJX7333IHP/FJX7337IHP/FJX7457IHP pracuje ve dvou provozních režimech:

Provozní režim	Popis
Standby	Střešní klimatizace je připravena k provozu a lze ji zapnout pomocí dálkového ovladače. K dispozici jsou okolní světla. Dálkový ovladač je rovněž v pohotovostním režimu, ale můžete jej zapnout nezávisle na střešní klimatizaci.
Zapnuto	Střešní klimatizace upravuje vzduch v interiéru.

## 9.3 Dometic FJX4233M

Uvedené informace v této kapitole platí pouze pro střešní klimatizace FJX4233M.

### 9.3.1 Zapnutí a vypnutí střešní klimatizace

Střešní klimatizace má dva režimy klimatizace:





- Režim Větrání (🌀)
- Režim Chlazení (❄️)



**Poznámka** Než přepnete z režimu Větrání do režimu Chlazení nebo naopak, počkejte minimálně 30 s. V opačném případě může spínací proud spálit pojistku.

Každý režim má tři nastavení:

- .: Nízká
- ...: Střední
- ...: Vysoká

- > Pro zapnutí otočte knoflík  do polohy režimu Větrání () nebo do polohy režimu Chlazení () a zvolte požadované nastavení.
- ✓ Střešní klimatizace je zapnutá a v provozu s hodnotami, které byly nastaveny před vypnutím.
- > Pro vypnutí otočte knoflík  do polohy 0.

### 9.3.2 Nastavení teploty

- > Otočte knoflíkem  do požadované polohy. Otáčení knoflíku ve směru hodinových ručiček znamená nižší teplotu.
- ✓ Na střešní klimatizaci je nastavena teplota.

## 9.4 FreshJet FJX4233EEH/FJX4333E(EH)/FJX7333IHP/FJX7337IHP/FJX7457IHP

Uvedené informace v této kapitole se vztahují pouze na střešní klimatizace FreshJet FJX4233EEH/FJX4333E(EH)/FJX7333IHP/FJX7337IHP/FJX7457IHP.

### 9.4.1 Pomocí dálkového ovládání

Při používání dálkového ovladače zvažte následující rady:

- Dálkový ovladač namířte na IR přijímač na ovládacím panelu.
- Odpovídající nastavení a hodnoty se po stisknutí tlačítka přenesou přímo do střešní klimatizace.
- Střešní klimatizace potvrdí příjem dat pípnutím.
- Hodnoty se zvyšují nebo snižují rychleji, když stisknete a podržíte stisknuté tlačítko + nebo -.
- V pohotovostním režimu je displej dálkového ovladače také neaktivní. Dálkový ovladač můžete přepnout do pohotovostního režimu nezávisle na střešní klimatizaci.
- > Chcete-li do pohotovostního režimu nebo z něj přepnout pouze dálkový ovladač, stiskněte tlačítko , aniž byste mířili na IR přijímač ovládacího panelu.

### 9.4.2 Zapnutí a přepnutí střešní klimatizace do pohotovostního režimu



**Poznámka** Když je střešní klimatizace zapnutá a v provozu s hodnotami, které byly nastaveny před přepnutím do pohotovostního režimu. Střešní klimatizaci lze vypnout pouze přerušením napájení.





- > Stisknutím tlačítka  na dálkovém ovladači nebo tlačítka  na ovládacím panelu střešní klimatizaci zapnete nebo přepnete do pohotovostního režimu.



### 9.4.3 Výběr režimu klimatizace

- > Pomocí tlačítka MODE (Režim) (Režimy klimatizace (pouze FJX4233EEH/FJX4333E(EH)/FJX7333IHP/FJX7337IHP/FJX7457IHP) na stránce 393) zvolte požadovaný režim klimatizace.
- ✓ Střešní klimatizace potvrdí příjem hodnot pípnutím. Střešní klimatizace se přepne do zvoleného režimu klimatizace.

### 9.4.4 Ruční výběr otáček ventilátoru

Ve všech režimech, kromě automatického (A) a odvlhčovacího (☺), lze rychlost ventilátoru zvolit ručně.

Hlášení na displeji	Popis
	Nízká úroveň ventilátoru
	Střední úroveň ventilátoru
	Vysoká úroveň ventilátoru.
	Turbo úroveň ventilátoru.
	Automatický režim (otáčky ventilátoru se nastavují na základě okolní teploty).

- > Stisknutím tlačítka  na dálkovém ovladači nebo tlačítka  na ovládacím panelu zvolte požadované otáčky ventilátoru.
- ✓ Sřešní klimatizace potvrdí příjem hodnot pípnutím.  
Nové otáčky ventilátoru jsou nastaveny.

### 9.4.5 Nastavení teploty

V režimech Automatika (A), Chlazení (❄), Topení (☀) a Odvlhčování (☺) můžete pomocí dálkového ovladače zadat teplotu mezi 16 °C a 31 °C.

- > Tlačítkem + nebo – na dálkovém ovladači nastavte požadovanou teplotu.
- ✓ Sřešní klimatizace potvrdí příjem hodnot vysokým tónem. Na sřešní klimatizaci je nastavena teplota.

### 9.4.6 Nastavení aktuálního času

K programování časovače vyžaduje dálkový ovladač aktuální čas. Čas je zobrazen na displeji dálkového ovladače.

1. Stisknutím a podržením tlačítka  se dostanete do režimu nastavení času.  
✓ Čas bliká na displeji dálkového ovladače.
2. Tlačítkem + nebo – nastavte aktuální čas. Stiskněte a podržte tlačítko + nebo – déle než 2 s pro rychlejší zvýšení nebo snížení času.
3. Stisknutím tlačítka SET potvrdíte nastavený čas.















### 9.4.7 Nastavení časovače

Pomocí funkce časovače můžete nastavit určitý časový rámec funkce klimatizace. Přitom můžete zadat čas zapnutí, čas přepnutí do pohotovostního režimu nebo obě hodnoty.

Funkce časovače se nastavuje pomocí dálkového ovladače.



**Poznámka** Pokud při programování časovače nestisknete po dobu 15 s žádné tlačítko na dálkovém ovladači, přepne dálkový ovladač zpět do výchozího režimu.







- > Nastavte **časovač zapnutí** následujícím způsobem:
  - a) Vybete požadovaný režim klimatizace a všechny požadované hodnoty (např. teplotu).
  - b) Podle potřeby přepněte střešní klimatizaci do pohotovostního režimu.  
Časovač zapnutí lze nastavit pouze tehdy, když je střešní klimatizace v **pohotovostním režimu**.
  - c) Stiskněte jednou tlačítko .
  - ✓ Na displeji dálkového ovladače bliká symbol  **ON**.
  - d) Pomocí tlačítka + nebo – nastavte čas, kdy se má střešní klimatizace zapnout.
  - e) Stiskněte tlačítko .
  - Časovač zapnutí je nastaven. Střešní klimatizace se zapne se zvoleným režimem klimatizace v zadaný čas.
- > **Časovač přepnutí do pohotovostního režimu** nastavte následujícím způsobem:
  - a) Podle potřeby zapněte střešní klimatizaci.  
Časovač přepnutí do pohotovostního režimu lze nastavit pouze tehdy, když je střešní klimatizace **zapnutá**.
  - b) Stiskněte dvakrát tlačítko .
  - ✓ Na displeji dálkového ovladače bliká symbol  **OFF**.
  - c) Pomocí tlačítka + nebo – nastavte čas, kdy se má střešní klimatizace přepnout do pohotovostního režimu.
  - d) Stiskněte tlačítko .
  - Časovač přepnutí do pohotovostního režimu je nastaven. Střešní klimatizace se v zadaném čase přepne do pohotovostního režimu.
- > Nastavte **časovač zapnutí** a **časovač přepnutí do pohotovostního režimu** takto:
  - a) Vybete požadovaný režim klimatizace a všechny požadované hodnoty (např. teplotu).
  - b) Stiskněte třikrát tlačítko .
  - ✓ Symbol  **ON**  **OFF** je zobrazen na displeji dálkového ovladače. Bliká symbol ON (Zapnuto).
  - c) Pomocí tlačítka + nebo – nastavte čas, kdy se má střešní klimatizace zapnout.
  - d) Stiskněte tlačítko .
  - ✓ Bliká symbol **OFF**.
  - e) Pomocí tlačítka + nebo – nastavte čas, kdy se má střešní klimatizace přepnout do pohotovostního režimu.
  - f) Stiskněte tlačítko .
  - ✓ Časovač zapnutí a časovač přepnutí do pohotovostního režimu jsou nastavené. Střešní klimatizace se zapne na zadanou dobu.
- > Chcete-li **zrušit** přednastavený časovač, stiskněte jednou tlačítko .
- ✓ Symboly  **ON**  **OFF** zmizí. Přednastavené hodnoty se zahodí.

### 9.4.8 Nastavení funkce spánku

Funkce spánku je k dispozici pouze v režimech Chlazení () nebo Topení (.

Funkce spánku omezuje otáčky ventilátoru na nižší úroveň, aby se snížila hladina hluku pro snazší spánek.

**Pouze FJX7333IHP/FJX7337IHP/FJX7457IHP:** Funkce spánku navíc omezuje otáčky kompresoru.

- > Chcete-li aktivovat funkci spánku, postupujte takto:
  - a) Nastavte požadovanou teplotu (Nastavení teploty na stránce 397).
  - b) Stiskněte tlačítko  na dálkovém ovladači nebo tlačítko  na ovládacím panelu.
- ✓ Na displeji dálkového ovladače se zobrazí symbol . Funkce spánku je aktivována.
  - > K deaktivaci funkce spánku stiskněte tlačítko  nebo  na dálkovém ovladači nebo tlačítko  na ovládacím panelu.
- ✓ Na displeji dálkového ovladače zmizí symbol . Funkce spánku je deaktivována.

### 9.4.9 Aktivace funkce I feel

Když je tato funkce aktivní, dálkové ovládání měří teplotu v místnosti a každých 10 minut přenáší tuto naměřenou hodnotu do střešní klimatizace. Střešní klimatizace tomuto měření přizpůsobí cílovou hodnotu. Funkce „I feel“ je aktivní pouze v případě, že se teplota pohybuje v rozmezí +18 °C až +29 °C.

Dálkový ovladač nesmí být umístěn v takové části prostoru, kde je výrazně tepleji nebo chladněji, než je průměrná teplota v prostoru. Nesmí být například ponechán na slunci nebo před střešní klimatizací.

Když teplota stoupne nad +29 °C nebo klesne pod +18 °C, funkce „I feel“ se deaktivuje. Symbol  na displeji třikrát blikne a poté zhasne.

1. Stiskněte tlačítko.
- ✓ Funkce „I feel“ je aktivovaná.

Na displeji se zobrazí symbol .

2. Umístěte dálkový ovladač tak, aby mířil na infračervený přijímač na ovládacím panelu. V opačném případě nelze hodnoty přenášet do střešní klimatizace.









### 9.4.10 Ovládání okolních světel



**VÝSTRAHA! Riziko zranění** Podle zákona je zakázáno používat při řízení vozidla vnější osvětlení.

Tlačítko  na dálkovém ovladači je aktivní, i když je dálkový ovladač vypnutý.

#### Pouze FreshJet FJX4233EEH/FJX4333E(EH)/FJX7333IHP/FJX7337IHP/FJX7457IHP:

- > Chcete-li zapnout nebo vypnout vnitřní světa, stiskněte tlačítko  na dálkovém ovladači nebo na ovládacím panelu.
  - ✓ Symbol  na displeji dálkového ovladače jednou blikne při **zapnutí** vnitřních světel.
    - > Vnitřní světa ztlumte tímto postupem:
      - a) Stiskněte tlačítko  na dálkovém ovladači nebo na ovládacím panelu pro 3 s.
      - b) Při stisknutí tlačítka  na dálkovém ovladači: Stisknutím tlačítka   ztlumíte vnitřní světa mezi hodnotami 50 % a 100 %.
      - c) Při stisknutí tlačítka  na ovládacím panelu: Jas vnitřního světa se cyklicky mění mezi hodnotami 50 % a 100 %.
- Po dosažení požadovaného jasu uvolněte tlačítko .

#### Pouze FreshJet FJX7333IHP/FJX7337IHP/FJX7457IHP:

- > Chcete-li zapnout nebo vypnout vnější světa, stiskněte tlačítko  na ovládacím panelu.

## 9.4.11 Výměna baterií dálkového ovladače



**Poznámka** Displej dálkového ovladače může být stále jasný, i když jsou baterie téměř vybité. Pokud dálkový ovladač signalizuje vybití baterií, vyměňte baterie.

- > Vyměňte baterie podle obrázku.

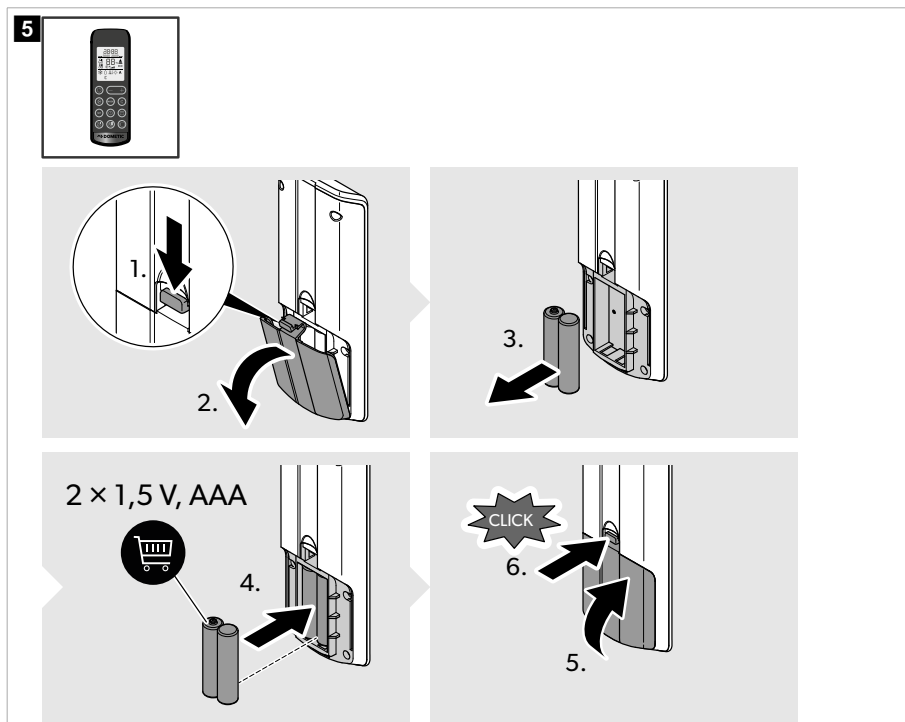

- ✓ Na displeji se zobrazí všechny symboly pro 5 s.



Chraňte životní prostředí! Baterie nevhazujte do běžného domovního odpadu. Vadné nebo použité baterie vraťte svému prodejci nebo je zlikvidujte ve sběrném dvoře.

## 9.5 Regulace přívodu vzduchu uvnitř vozidla

Průtok vzduchu lze nastavit podél stropu nebo směrem k podlaze.



- > Otočte lamely ve výdeších vzduchu nezávisle v požadovaných směrech.

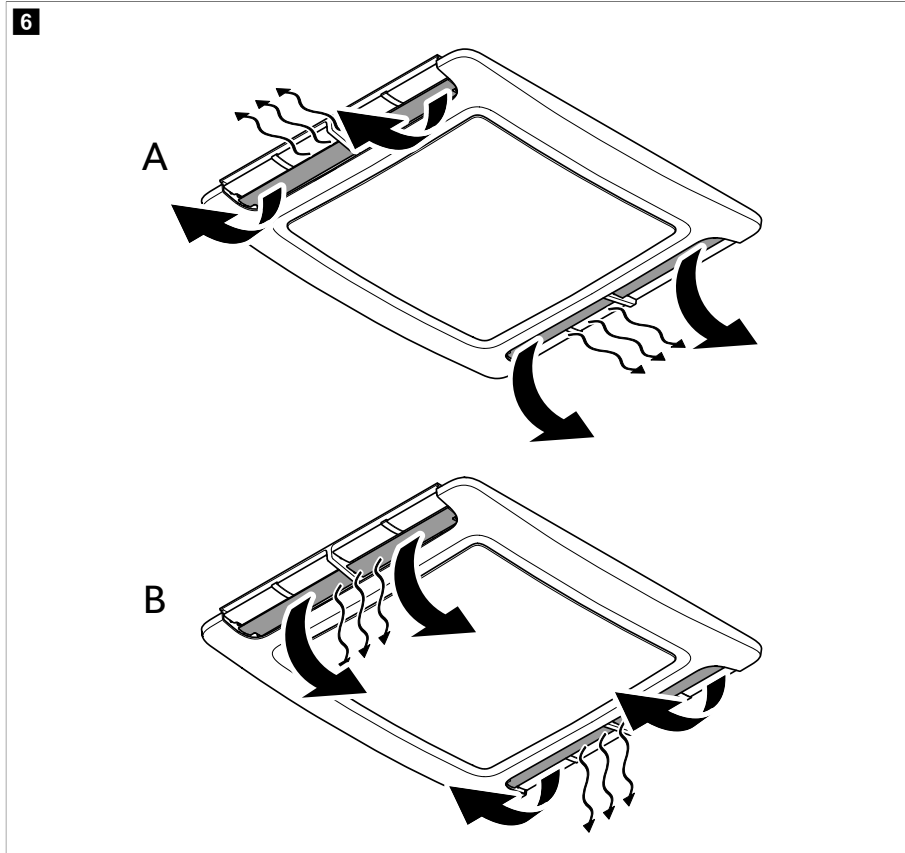

## 10 Čištění střešní klimatizace



### POZOR! Nebezpečí poškození

- K urychlení rozmrazování nebo čištění nepoužívejte jiné než výrobcem doporučené prostředky.
- Nikdy nečistěte střešní klimatizaci vysokotlakým čističem. Vniknutím vody může dojít k poškození střešní klimatizace.
- K čištění nepoužívejte žádné tvrdé nebo ostré předměty nebo čisticí prostředky, může dojít k poškození střešní klimatizace.
- V žádném případě nepoužívejte benzín, naftu nebo rozpouštědla.

1. Ze sání vzduchu a ventilačních mřížek na střešní klimatizaci pravidelně odstraňujte listí a jiné nečistoty. Nepoškodte ventilační mřížky.

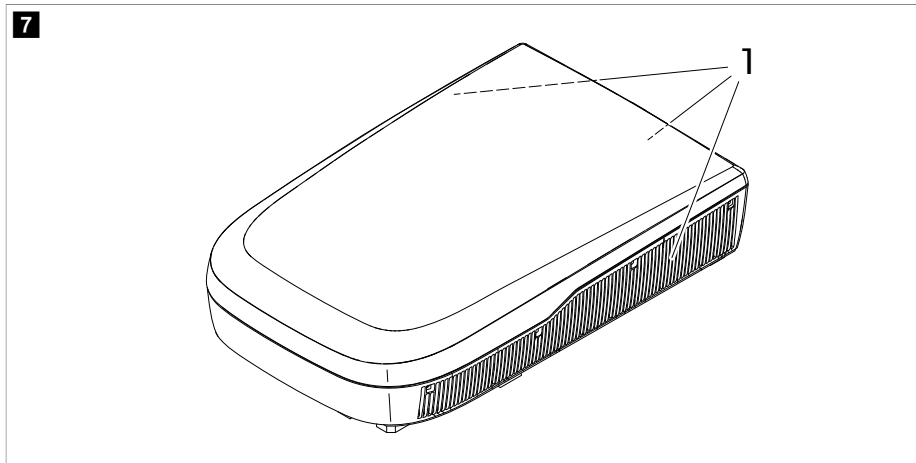

2. Příležitostně očistěte kryty střešní jednotky a rozvaděč vzduchu vlhkou utěrkou. Použijte pouze vodu s šetrným čisticím prostředkem.
3. **Pouze FreshJet FJX4233EEH/FJX4333E(EH)/FJX7333IHP/FJX7337IHP/FJX7457IHP:** Příležitostně vyčistěte dálkový ovladač mírně zvlhčenou utěrkou. K čištění displeje použijte ubrousek k čištění brýlí.
4. **Pouze FreshJet FJX4233EEH/FJX4333E(EH)/FJX7333IHP/FJX7337IHP/FJX7457IHP** Příležitostně očistěte displej rozvaděče vzduchu jemným roztokem teplé mýdlové vody. Obrazovka displeje je akrylová a může se poškodit některými běžnými chemikáliemi pro domácnost, jako jsou chemické čisticí prostředky, čisticí prostředky na okna, alkohol, určité tenzidy, organická rozpouštědla a změkčovadla.

## 11 Údržba

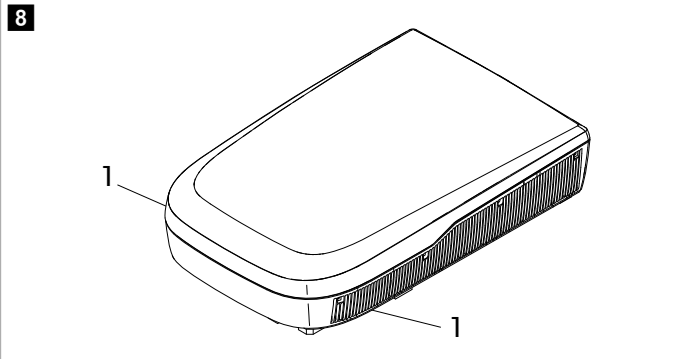
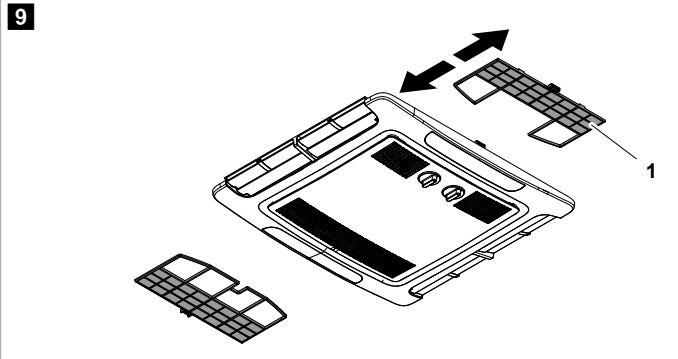

**VÝSTRAHA! Riziko zranění** Jiné kroky údržby střešní klimatizace navíc k těm, které jsou zde popsány, smějí provádět pouze odborníci, kteří jsou seznámeni s nebezpečími při manipulaci s chladivou a klimatizačními zařízeními a s příslušnými předpisy.

Interval	Kontrola/údržba
Pravidelně	<p>Zkontrolujte, zda jsou odtokové kanálky kondenzované vody (1) po stranách střešní klimatizace čisté a kondenzovaná voda může odtékat.</p> <div data-bbox="333 248 1016 616"> <p><b>8</b></p>  </div>
Pravidelně (Freshjet FJX4233M)	<p>Vyčistěte filtr jednotky vyfukování vzduchu.</p> <div data-bbox="333 683 1016 1050"> <p><b>9</b></p>  </div> <ol style="list-style-type: none"> <li>1. Odstraňte filtr (1).</li> <li>2. Vyčistěte filtr (1) čisticím roztokem a nechte je vyschnout.</li> <li>3. Vložte zpět suchý filtr (1).</li> </ol>

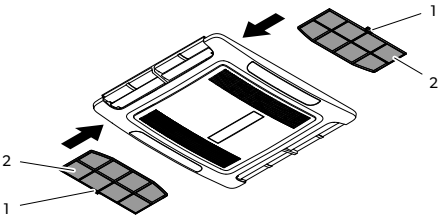
Interval	Kontrola/údržba
Pravidelně (FreshJet FJX4233EEH/FJX4333E(E-H)/FJX7333IHP/FJX7337IHP/FJX7457IHP)	<ul style="list-style-type: none"> <li>• Vyčistěte filtr jednotky vyfukování vzduchu.</li> </ul> <div data-bbox="367 225 1016 528" style="border: 1px solid black; padding: 10px;"> <p><b>10</b></p>  </div> <ol style="list-style-type: none"> <li>1. Vložte plochý šroubovák nebo nůž do rukojeti (1), abyste filtry (2) povytáhli.</li> <li>2. Filtry vyjměte ručně.</li> <li>3. Vyčistěte filtry čisticím roztokem a nechte je vyschnout.</li> <li>4. Zasuňte zpět suché filtry. obr. 10 na stránce 404</li> </ol> <ul style="list-style-type: none"> <li>• Nechejte provést údržbu výměníku střešní klimatizace v odborné firmě.</li> </ul>
Jednou ročně	<ul style="list-style-type: none"> <li>• Zkontrolujte těsnění mezi střešní klimatizací a střechou vozidla, zda neobsahuje praskliny a jiná poškození.</li> <li>• Zkontrolujte, zda jsou upevňovací šrouby utaženy na správný utahovací moment (2.5 Nm <math>\pm</math> 0.3 Nm), a v případě potřeby je seřídte.</li> </ul>

## 12 Odstraňování poruch a závad

Porucha	Možná příčina	Návrh řešení
Nedostatečné chlazení	Střešní klimatizace není nastavena na chlazení.	Nastavte střešní klimatizaci na chlazení.
	Okolní teplota je vyšší než 52 °C.	Střešní klimatizace je konstruována pouze na okolní teplotu do 52 °C.
	Nastavená teplota je vyšší než teplota v prostoru.	Nastavte nižší teplotu.
	Okolní teplota je nižší než 16 °C.	Střešní klimatizace je konstruována pro chlazení pouze při okolní teplotě nad 16 °C.
	Jedno z teplotních čidel je vadné.	Kontaktujte autorizovaného zástupce servisu nebo firmu Dometic.
	Ventilátor výparníku je poškozený.	Kontaktujte autorizovaného zástupce servisu nebo firmu Dometic.
	Ventilátor kondenzátoru je poškozený.	Kontaktujte autorizovaného zástupce servisu nebo firmu Dometic.

Porucha	Možná příčina	Návrh řešení
<b>Pouze FreshJet FJX4233EEH/ FJX4333E(EH)/FJX7333IHP/ FJX7337IHP/FJX7457IHP:</b> Nedostatečné topení	Střešní klimatizace není nastavena na topení.	Nastavte střešní klimatizaci na topení.
	Okolní teplota je nižší než $-2\text{ }^{\circ}\text{C}$ .	Střešní klimatizace je konstruována pro okolní teploty nad $-2\text{ }^{\circ}\text{C}$ .
	Nastavená teplota je nižší než teplota v místnosti.	Zvolte vyšší teplotu.
	Jedno z teplotních čidel je vadné.	Kontaktujte autorizovaného zástupce servisu nebo firmu Dometic.
	Ventilátor výparníku je poškozený.	Kontaktujte autorizovaného zástupce servisu nebo firmu Dometic.
Malý výstup vzduchu	Otvory sání vzduchu jsou blokovány nebo ucpaný.	Z ventilačních mřížek na střešní klimatizaci odstraňte případné listí a jiné nečistoty.
	Vadný ventilátor.	Kontaktujte autorizovaného zástupce servisu nebo firmu Dometic.
Do vozidla teče voda.	Otvory pro odtok kondenzátu jsou ucpané.	Vyčistěte otvory pro odtok vody od kondenzované vody.
	Poškozené těsnění.	Kontaktujte autorizovaného zástupce servisu nebo firmu Dometic.
Střešní klimatizaci nelze zapnout.	Napájení není připojeno.	Zkontrolujte přívod proudu.
	Napětí je příliš nízké ( $< 200\text{ V}$ ).	Kontaktujte autorizovaného zástupce servisu nebo firmu Dometic.
	Vadný měnič napětí.	Kontaktujte autorizovaného zástupce servisu nebo firmu Dometic.
	Jedno z teplotních čidel je vadné.	Kontaktujte autorizovaného zástupce servisu nebo firmu Dometic.
	Elektrická pojistka napájení je příliš nízká.	Kontaktujte autorizovaného zástupce servisu nebo firmu Dometic.
Střešní klimatizaci nelze vypnout.	Jedno z teplotních čidel je vadné.	Kontaktujte autorizovaného zástupce servisu nebo firmu Dometic.
	Elektrická pojistka napájení je příliš nízká.	Kontaktujte autorizovaného zástupce servisu nebo firmu Dometic.
<b>Pouze FreshJet FJX4233EEH/ FJX4333E(EH)/FJX7333IHP/ FJX7337IHP/FJX7457IHP:</b> Střešní klimatizace se neustále vypíná.	Sepnul snímač zamrznutí.	Vnější teplota je příliš nízká nebo jsou všechny výdechy vzduchu zavřené.
Na displeji se zobrazí hlášení: PO	Nadměrná teplota nebo nadměrný proud na modulu IPM	Kontaktujte autorizovaného zástupce servisu nebo firmu Dometic.

Porucha	Možná příčina	Návrh řešení
Na displeji se zobrazí hlášení: P1	Podpěťová ochrana	Kontaktujte autorizovaného zástupce servisu nebo firmu Dometic.
Na displeji se zobrazí hlášení: P2	Nadproudová ochrana klimatizace	Kontaktujte autorizovaného zástupce servisu nebo firmu Dometic.
Na displeji se zobrazí hlášení: P4	Ochrana proti přehřátí výtokové trubky	Kontaktujte autorizovaného zástupce servisu nebo firmu Dometic.
Na displeji se zobrazí hlášení: P5	Ochrana výparníkové cívky (režim chlazení)	Kontaktujte autorizovaného zástupce servisu nebo firmu Dometic.
Na displeji se zobrazí hlášení: P6	Ochrana kondenzátorové cívky (režim chlazení)	Kontaktujte autorizovaného zástupce servisu nebo firmu Dometic.
Na displeji se zobrazí hlášení: P7	Ochrana výparníkové cívky (režim topení)	Kontaktujte autorizovaného zástupce servisu nebo firmu Dometic.
Na displeji se zobrazí hlášení: P9	Neobvyklý pohon kompresoru nebo kompresor se nespustí	Kontaktujte autorizovaného zástupce servisu nebo firmu Dometic.
Na displeji se zobrazí hlášení: E0	Porucha komunikace	Kontaktujte autorizovaného zástupce servisu nebo firmu Dometic.
Na displeji se zobrazí hlášení: E1	Porucha čidla pokojové teploty	Kontaktujte autorizovaného zástupce servisu nebo firmu Dometic.
Na displeji se zobrazí hlášení: E2	Porucha čidla teploty výparníkové cívky	Kontaktujte autorizovaného zástupce servisu nebo firmu Dometic.
Na displeji se zobrazí hlášení: E3	Porucha čidla teploty kondenzátorové cívky	Kontaktujte autorizovaného zástupce servisu nebo firmu Dometic.
Na displeji se zobrazí hlášení: E7	Porucha čidla venkovní teploty	Kontaktujte autorizovaného zástupce servisu nebo firmu Dometic.
Na displeji se zobrazí hlášení: E8	Porucha čidla teploty výtokové trubky	Kontaktujte autorizovaného zástupce servisu nebo firmu Dometic.
Na displeji se zobrazí hlášení: E9	Porucha pohonu kompresoru nebo modulu IPM	Kontaktujte autorizovaného zástupce servisu nebo firmu Dometic.
Na displeji se zobrazí hlášení: EA	Porucha čidla proudu	Kontaktujte autorizovaného zástupce servisu nebo firmu Dometic.
Na displeji se zobrazí hlášení: EE	Porucha vnější paměti EEPROM	Kontaktujte autorizovaného zástupce servisu nebo firmu Dometic.
Na displeji se zobrazí hlášení: EL	Porucha komunikace LIN-BUS/CI-BUS	Kontaktujte autorizovaného zástupce servisu nebo firmu Dometic.

## 13 Likvidace



Obalový materiál pokud možno zlikvidujte do vhodných recyklačních odpadních nádob. Informace o likvidaci výrobku v souladu s platnými předpisy pro likvidaci vám sdělí místní recyklační středisko nebo specializovaný prodejce.



Chraňte životní prostředí! Baterie nevhazujte do běžného domovního odpadu. Vadné nebo použité baterie vraťte svému prodejci nebo je zlikvidujte ve sběrném dvoře.

## 14 Záruka

Na výrobek je poskytována záruka v souladu s platnými zákony. Pokud je výrobek vadný, kontaktujte pobočku výrobce ve vaší zemi nebo svého prodejce (viz [dometic.com/dealer](http://dometic.com/dealer)).

K vyřízení opravy nebo záruky nezapomeňte odeslat následující dokumenty:

- kopii účtenky s datem zakoupení,
- uvedení důvodu reklamace nebo popis vady.

Upozorňujeme, že oprava svépomocí nebo neodborná oprava může ohrozit bezpečnost a vést ke ztrátě záruky.

## 15 Technické údaje

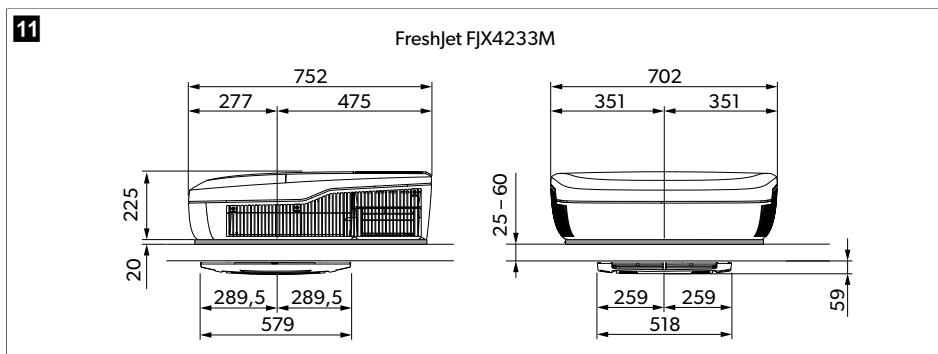

12

FJX4233EEH, FJX4333E(EH), FJX7333IHP

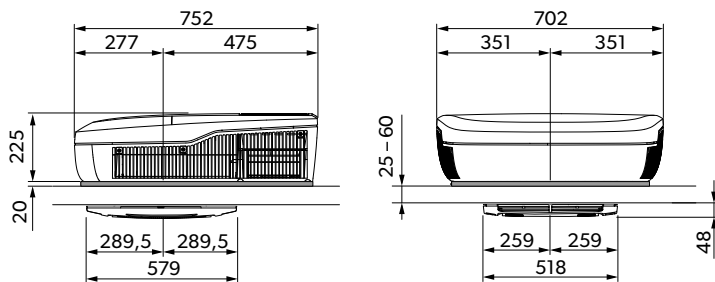

13

FreshJet FJX7337IHP

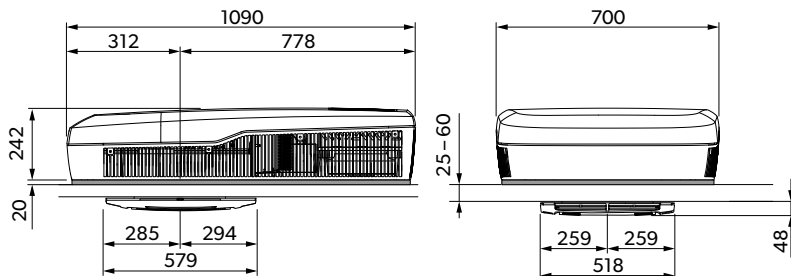

14

FreshJet FJX7457IHP

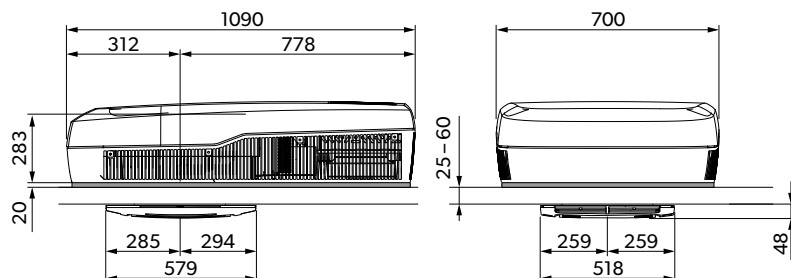

Obsahuje fluorované skleníkové plyny. Hermeticky utěsněné zařízení.

	<b>FreshJet FJX4233M</b>
Chladicí výkon v souladu s ISO 5151:	1500 W
Vstupní napětí střídavého proudu:	220 V ... 240 V / 50 Hz



	<b>FreshJet FJX4233M</b>
Jmenovitý proud chlazení:	< 3.3 A
Požadovaná pojistka:	4 A
Rozsah provozních teplot:	- 2 °C ... 52 °C
Chladicí médium:	R410a
Množství chladicího média:	380 g
Ekvivalent CO <sub>2</sub> :	0.793 t
Potenciál skleníkových plynů (GWP):	2088
Stupeň krytí (střešní jednotka):	IPX4
Hlučnost (nejvyšší nastavení ventilátoru)	< 70 dB(A)
Navržená max. délka vozidla (s izolovanými stěnami):	< 5 m
Rozměry D x Š x V	obr. 11 na stránce 407
Hmotnost:	< 30 kg
Zkouška/certifikát:	

	<b>FreshJet FJX4233EEH</b>	<b>FreshJet FJX4333EEH</b>	<b>FreshJet FJX4333E</b>
Chladicí výkon v souladu s ISO 5151:	1700 W	2200 W	2200 W
Chladicí výkon v souladu s ISO 5151:	800 W	1000 W	-
Vstupní napětí střídavého proudu:	220 V ... 240 V / 50 Hz		
Jmenovitý proud chlazení:	3.6 A	4.8 A	4.8 A
Jmenovitý proud topení:	< 5.2 A	< 5.2 A	-
Požadovaná pojistka:	4 A	5 A	6 A
Rozsah provozních teplot:	- 2 °C ... 52 °C		
Chladicí médium:	R32		
Množství chladicího média:	320 g	360 g	360 g

	<b>FreshJet FJX4233EEH</b>	<b>FreshJet FJX4333EEH</b>	<b>FreshJet FJX4333E</b>
Ekvivalent CO <sub>2</sub> :	0.216 t	0.243 t	0.243 t
Potenciál skleníkových plynů (GWP):	675		
Stupeň krytí (střešní jednotka):	IPX4		
Hlučnost (nejvyšší nastavení ventilátoru)	< 70 dB(A)		
Navržená max. délka vozidla (s izolovanými stěnami):	< 6 m	< 7 m	< 7 m
Rozměry D x Š x V	obr. 12 na stránce 408		
Hmotnost:	< 30 kg	< 30 kg	< 30 kg
Zkouška/certifikát:			
	<b>FreshJet FJX7333IHP</b>	<b>FreshJet FJX7337IHP</b>	<b>FreshJet FJX7457IHP</b>
Chladicí výkon v souladu s ISO 5151:	2200 W	3000 W	3500 W
Chladicí výkon v souladu s ISO 5151:	2000 W	2500 W	3000 W
Vstupní napětí střídavého proudu:	220 V ... 240 V / 50 Hz ... 60 Hz	220 V ... 240 V / 50 Hz ... 60 Hz	220 V ... 240 V / 50 Hz ... 60 Hz
Jmenovitý proud chlazení:	< 7.5 A	< 7.5 A	< 7.5 A
Jmenovitý proud topení:	< 6.1 A	< 6.1 A	< 6.1 A
Požadovaná pojistka:	6 A	6 A	6 A
Rozsah provozních teplot:	- 2 °C ... 52 °C	- 2 °C ... 52 °C	- 2 °C ... 52 °C
Chladicí médium:	R32	R32	R32
Množství chladicího média:	420 g	480 g	650 g
Ekvivalent CO <sub>2</sub> :	0.2835 t	0.3240 t	0.43875 t
Potenciál skleníkových plynů (GWP):	675		
Stupeň krytí (střešní jednotka):	IPX4		
Hlučnost (nejvyšší nastavení ventilátoru)	< 70 dB(A)		

	<b>FreshJet FJX7333IHP</b>	<b>FreshJet FJX7337IHP</b>	<b>FreshJet FJX7457IHP</b>
Navržená max. délka vozidla (s izolovanými stěnami):	< 7 m	< 7 m	> 8 m
Rozměry D x Š x V	obr. <b>12</b> na stránce 408	obr. <b>13</b> na stránce 408	obr. <b>14</b> na stránce 408
Hmotnost:	< 30 kg	< 35 kg	< 40 kg
Zkouška/certifikát:			

## Hungarian

1	Important notes.....	412
2	Szimbólumok magyarázata.....	412
3	Biztonsági útmutatások.....	413
4	Rendeltetésszerű használat.....	414
5	Szimbólumok magyarázata a készüléken.....	415
6	Műszaki korlátok és feltételek.....	415
7	Műszaki leírás.....	415
8	Az első használat előtt.....	421
9	Üzemeltetés.....	421
10	A tetőklíma-berendezés tisztítása.....	429
11	Karbantartás.....	429
12	Hibaelhárítás.....	431
13	Ártalmatlanítás.....	434
14	Szavatosság.....	434
15	Műszaki adatok.....	434

## 1 Important notes

A termék mindenkor szakszerű telepítése, használata és karbantartása érdekében kérjük figyelmesen olvassa el az ebben a termék kézikönyvben található utasításokat, irányelveket és figyelmeztetéseket, valamint mindig tartsa be ezeket. Ezt az útmutatót a termék közelében KELL tartani.

A termék használatba vételével Ön kijelenti hogy figyelmesen elolvasta az összes utasítást, irányelvet és figyelmeztetést, valamint megértette és elfogadja az itt leírt szerződési feltételeket. Ön elfogadja, hogy kizárólag a rendeltetésének megfelelő célra és a jelen termék kézikönyvben leírt útmutatásoknak, irányelveknek és figyelmeztetéseknek, valamint a hatályos törvényeknek és szabályozásoknak megfelelően használja ezt a terméket. Az itt leírt utasítások és figyelmeztetések elolvasásának és betartásának elmulasztása saját és mások sérüléséhez, a termék vagy a közelben található más anyagi javak károsodásához vezethet. Ez a termék kézikönyv és a benne található utasítások, irányelvek és figyelmeztetések, valamint a kapcsolódó dokumentációk módosulhatnak és frissülhetnek. Naprakész termékinformációk érdekében kérjük látogasson el a következő honlapra: [documents.dometic.com](http://documents.dometic.com).

## 2 Szimbólumok magyarázata



**VESZÉLY!** Veszélyes helyzetet jelöl, amely súlyos sérülést vagy halált okoz, ha nem kerülik el.



**FIGYELMEZTETÉS!** Veszélyes helyzetet jelöl, amely súlyos sérülést vagy halált okoz, ha nem kerülik el.



**VIGYÁZAT!** Veszélyes helyzetet jelöl, amely könnyű vagy mérsékelt sérülést okozhat, ha nem kerülik el.



**FIGYELEM!** Veszélyes helyzetet jelöl, amely könnyű vagy mérsékelt sérülést okozhat, ha nem kerülik el.



**Megjegyzés** A termék kezelésére vonatkozó kiegészítő információk.

### 3 Biztonsági útmutatások



**FIGYELMEZTETÉS!** Ezeknek a figyelmeztetéseknek a figyelmen kívül hagyása súlyos, vagy halálos sérüléshez vezethet.

- **Az elektromos berendezés nem játék.** A készüléket nem használhatják korlátozott fizikai, érzékelési és mentális képességű, illetve megfelelő tapasztalattal és tudással nem rendelkező személyek (beleértve a gyermekeket is), hacsak nem állnak felügyelet alatt vagy nem kaptak megfelelő utasításokat.
- A gyermekeket felügyelni kell annak érdekében, hogy ne játsszanak a készülékkel.
- A készüléket 8 év feletti gyermekek, valamint korlátozott fizikai, érzékelési és mentális képességű, illetve megfelelő tapasztalattal és tudással nem rendelkező személyek csak felügyelet mellett, illetve a készülék biztonságos használatát és az abból eredő veszélyeket megértve használhatják.
- A tisztítást gyermekek felügyelet nélkül nem végezhetik.
- Minden személynek, aki hűtőközeg körön dolgozik, vagy megbontja a hűtőközeg kört, rendelkeznie kell egy, az iparágban akkreditált értékelő hatóság által kiállított, jelenleg érvényes tanúsítvánnyal, amely felhatalmazza a személyt a hűtőközegek egy, az iparágban elismert értékelési specifikációnak megfelelő biztonságos kezelésére.
- A karbantartást csak a berendezés gyártója által ajánlott módon szabad elvégezni. A más szakképzett személyzet közreműködését igénylő karbantartást és javítást a gyűlékony hűtőközegek használatában jártas személy felügyelete mellett kell elvégezni.
- A készülék javítást csak olyan szakember végezheti, aki ismeri az ezzel kapcsolatos veszélyeket, illetve vonatkozó előírásokat. A szakszerűtlen javítások jelentős veszélyeket okozhatnak. Javítás esetén forduljon az Ön országában illetékes szervizközponthoz (lásd: [dometic.com/dealer](http://dometic.com/dealer)).
- A készüléken történő munkavégzés előtt mindig szakítsa meg az áramellátást.
- A készüléket olyan helyiségben tárolja, amelyben nincsenek folyamatos üzemű szikraforrások, például nyílt láng, üzemelő gázkészülék, vagy üzemelő elektromos fűtőkészülék.
- Ne szúrja ki és ne dobja tűzbe a készüléket.
- Vegye figyelembe, hogy a hűtőközegek szagtalanok lehetnek.
- Ne használja a készüléket gyűlékony folyadékok közelében vagy zárt térben.
- Ügyeljen arra, hogy a levegőkivezető nyílás területén ne legyenek éghető tárgyak tárolva vagy felszerelve. A távolság legalább 50 cm legyen.
- Tartsa szabadon a szellőzőnyílásokat.
- Ne tegyen kárt a hűtőkörben.
- A hűtőközeg szívárgások keresése vagy felderítése során semmilyen körülmények között nem szabad potenciális szikraforrásokat használni. Halogénlámpát (vagy más, nyílt lángot alkalmazó érzékelőt) tilos használni.
- A tetőklima-berendezést olyan járműbe kell beszerelni, amelynek padlófelülete nagyobb, mint 4 m<sup>2</sup>.



**VIGYÁZAT! Ezeknek a felhívásoknak a figyelmen kívül hagyása könnyű vagy mérsékelt sérüléshez vezethet.**

- Ne nyúljon a levegőkivezető nyílásaiba, és ne vezessen be idegen tárgyakat a készülékbe.
- Tűz esetén ne vegye le a készülék felső fedelét. Helyette használjon engedélyezett oldószereket. Az oltáshoz ne használjon vizet.
- Ha a tápkábel megsérül, akkor azt a veszélyeztetések elkerülése érdekében a gyártóval, annak szervizszolgálatával vagy egy hasonlóan képzett személlyel cseréltesse ki.
- Abban az esetben, ha a készülék ionizátort tartalmaz, és valamilyen egészségügyi problémája van, konzultáljon orvosával. Az ionizátor kis mennyiségben ózont (O<sub>3</sub>) termelhet. Ha tüdőbetegségben, asztmában, szívbetegségben, légzőszervi betegségben, légzési problémában, vagy ózonérzékenységben szenved, forduljon orvosához, aki eldönti, biztonságos-e Ön számára a készülék használata.



**FIGYELEM! Károsodás veszélye**

- A leolvasztás, vagy a tisztítás meggyorsítása érdekében ne használjon más módszereket, mint amelyek a gyártó javasol.
- A készüléket úgy kell tárolni, hogy ne keletkezzenek mechanikai sérülések.
- Ne végezzen módosításokat vagy átépítéseket a készüléken!
- Felszerelt tetőklima-berendezéssel tilos autómósó berendezésbe behajtani.
- Ha a hűtőközeg körben hiba lép fel, a készüléket a veszélyek elkerülése érdekében a gyártónak, annak szervizének vagy hasonlóan képzett személynek kell ellenőriznie és megjavítania.

## 4 Rendeltetészerű használat

A FreshJet FJX tetőklima-berendezés hűtés biztosítása céljából kizárólag lakókocsi vagy lakóautó tetejére történő felszerelésre alkalmas.

A tetőklima-berendezés vonatkozhoz, házakhoz és lakásokhoz **nem** alkalmas. A tetőklima-berendezés építőipari gépekbe, mezőgazdasági gépekbe vagy hasonló munkakészülékekbe történő beszerelésre **nem** alkalmas.

Ez a termék az itt leírt utasításoknak megfelelő rendeltetészerű használatra alkalmas.

Ez a kézikönyv olyan információkat nyújt, amelyek a termék szakszerű telepítéséhez és/vagy üzemeltetéséhez szükségesek. A hibás telepítés és/vagy a szakszerűtlen üzemeltetés vagy karbantartás elégtelen teljesítményhez és potenciálisan meghibásodáshoz vezethet.

A gyártó nem vállal felelősséget a termék olyan károsodásáért, vagy sérülésekért, amelyek a következőkre vezethetők vissza:

- Hibás összeszerelés vagy csatlakoztatás, ideértve a túlfeszültséget is
- Helytelen karbantartás, vagy a gyártó által szállított eredeti cserealkatrészekről eltérő cserealkatrészek használata
- A termék kifejezett gyártói engedély nélküli módosítása
- Az útmutatóban leírt céloktól eltérő felhasználás

A Dometic fenntartja a termék megjelenésének és specifikációjának módosítására vonatkozó jogát.

## 5 Szimbólumok magyarázata a készüléken



Figyelmeztetés! Kis sebességgel égő anyag.



Olvassa el a használati utasítást.



Olvassa el a szerviz kézikönyvet.

## 6 Műszaki korlátok és feltételek

A tetőklíma-berendezés 25 mm ... 60 mm vastagságú tetővel rendelkező járművekhez alkalmas. A tetőklíma-berendezés működése  $-2\text{ }^{\circ}\text{C}$  ...  $52\text{ }^{\circ}\text{C}$  közötti környezeti hőmérsékleten garantált. A tetőklíma-berendezést a vízszintes síkhoz képest  $\pm 10^{\circ}$  belüli eltéréssel kell felszerelni. Ha erős rezgéseknek van kitéve, például rossz útviszonyok miatt, akkor a tetőklíma-berendezés teljesítménye csökkenhet.

## 7 Műszaki leírás

A FreshJet FJX4233M tetőklíma-berendezés por- és szennyeződésmentes, páramentesített, hűvös levegővel látja el a jármű belső terét.

A FreshJet FJX4233EEH/FJX4333E(EH)/FJX7333IHP/FJX7337IHP/FJX7457IHP tetőklíma-berendezés por- és szennyeződésmentes, páramentesíthető, hűvös vagy meleg levegővel látja el a jármű belső terét.

A tetőklíma-berendezés képes a jármű belsejének hőmérsékletét egy bizonyos szintre csökkenteni, amely a jármű típusától, a környezeti hőmérséklettől és a tetőklíma-berendezés hűtési kapacitásától függ.  $16\text{ }^{\circ}\text{C}$  külső hőmérséklet alatt a tetőklíma-berendezés már nem hűt.

A tetőklíma-berendezés a következő kezelőelemekkel működik:

- Kezelőpanel

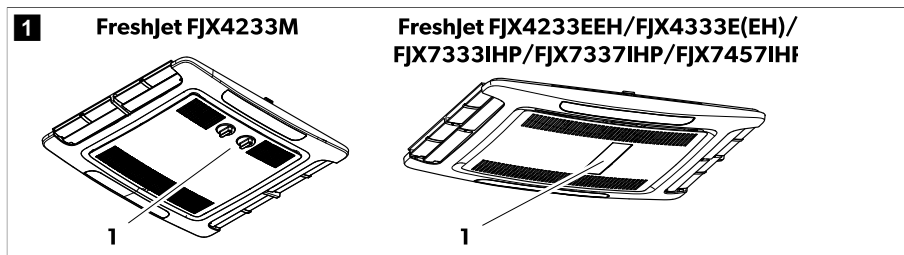

- Távirányító (csak a következő modelleknél: FJX4233EEH/FJX4333E(EH)/FJX7333IHP/FJX7337IHP/FJX7457IHP)

## 7.1 Modellek listája

A következő táblázatban látható, hogy melyik funkció melyik modellre vonatkozik:

- A funkció elérhető
- A funkció frissíthető

	FJX4233M	FJX4233EEH	FJX4333EEH	FJX4333E	FJX7333IHP	FJX7337IHP	FJX7457IHP
Automatikus		●	●	●	●	●	●
Hűtés	●	●	●	●	●	●	●
Melegítés		●	●	○	●	●	●
Szellőztetés	●	●	●	●	●	●	●
Pára-mentesítés		●	●	●	●	●	●
Levegő-tisztító	○	●	●	○	●	●	●
ADB lámpa		●	●	○	●	●	●
Külső világítás					●	●	●
Időzítő		●	●	●	●	●	●
Alvás		●	●	●	●	●	●
Lágyindítás			●	○	●	●	●

## 7.2 FreshJet FJX4233M vezérlőpanel

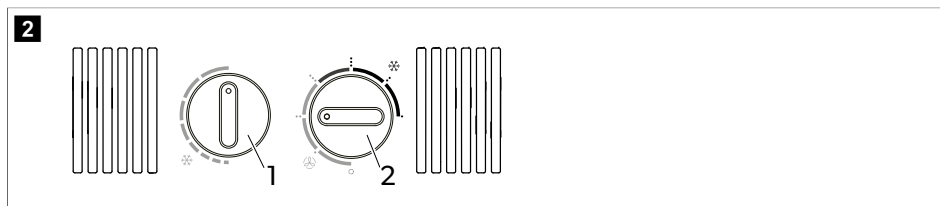



gomb	Leírás
	Kiválasztja a hőmérsékletet. Az óramutató járásával egyező irányba elforgatva nagyobb hűtést érhet el.
	Be- vagy kikapcsolja a tetőklima-berendezést, és kiválasztja a levegőkeringetés intenzitását a Szellőztetés (🌀) üzemmódban, illetve a hűtés intenzitását a Hűtés (❄️) üzemmódban.

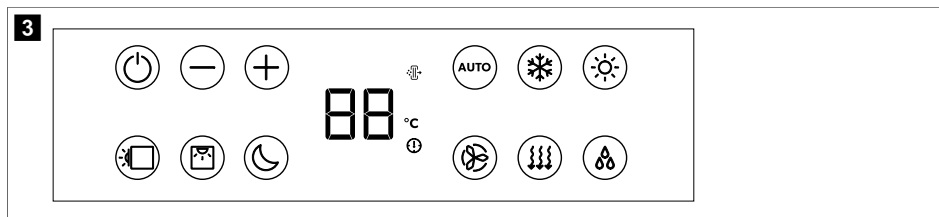

### 7.3 FreshJet FJX4233EEH/FJX4333E(EH)/FJX7333IHP/FJX7337IHP/FJX7457IHP vezérlőpanel



















Szimbólum	Leírás
	Készenléti üzemmódba kapcsolja a tetőklima-berendezést.
	növeli a pillanatnyilag kijelzett értéket.
	csökkenti a pillanatnyilag kijelzett értéket.
	Bluetooth/WLAN párosítás, ha mindkét gombot egyszerre lenyomja.
	Be- vagy kikapcsolja a tetőegység térvilágítását.
	Be- vagy kikapcsolja a levegőelosztó doboz térvilágítását.
	Aktiválja az alvás funkciót (További funkciók (csak a következő modelleknél: FJX4233EEH/FJX4333E(EH)/FJX7333IHP/FJX7337IHP/FJX7457IHP) 420. oldal).
	Kijelzi a beállított hőmérsékletet, és a ventilátor állítása esetén mutatja a ventilátor fokozatát.
	Jelzi, hogy az AirPurifier üzemmód aktív.
	Jelzi, hogy a hőmérséklet Celsius fokban jelenik meg.
	Jelzi, hogy be van állítva az időzítő.
	Bekapcsolja/kikapcsolja az automatikus üzemmódot (Légkondicionálási üzemmódok (csak a következő modelleknél: FJX4233EEH/FJX4333E(EH)/FJX7333IHP/FJX7337IHP/FJX7457IHP) 420. oldal).
	Engedélyezi/letiltja a hűtési üzemmódot (Légkondicionálási üzemmódok (csak a következő modelleknél: FJX4233EEH/FJX4333E(EH)/FJX7333IHP/FJX7337IHP/FJX7457IHP) 420. oldal).
	Engedélyezi/letiltja a fűtési üzemmódot (Légkondicionálási üzemmódok (csak a következő modelleknél: FJX4233EEH/FJX4333E(EH)/FJX7333IHP/FJX7337IHP/FJX7457IHP) 420. oldal).
	Alacsony, közepes, magas, turbó, vagy automatikus beállítás között állítja a ventilátor fordulatszámát (módosításkor rövid ideig 1, 2, 3, 4 vagy AA jelzi a levegőelosztó doboz kijelzőjén).

Szimbólum	Leírás
	Engedélyezi/letiltja a szellőztetés üzemmódot (Légkondicionálási üzemmódok (csak s következő modelleknel: FJX4233EEH/FJX4333E(EH)/FJX7333IHP/FJX7337IHP/FJX7457IHP) 420. oldal). Fűtés vagy hűtés nélkül keringtetni a levegőt.
	Engedélyezi/letiltja a páramentesítés üzemmódot (Légkondicionálási üzemmódok (csak s következő modelleknel: FJX4233EEH/FJX4333E(EH)/FJX7333IHP/FJX7337IHP/FJX7457IHP) 420. oldal).

## 7.4 Freshjet FJX4233EEH/FJX4333E(EH)/FJX7333IHP/FJX7337IHP/FJX7457IHP távirányító





Kezelő- és kijelzőelemek . ábra **4** 418. oldal :

Gomb	Leírás
—	<p><b>Kijelző</b></p> <p>A következőket jelzi ki:</p> <ul style="list-style-type: none"> <li>• Idő</li> <li>• Kiválasztott beltéri hőmérséklet (célérték) °C egységben</li> <li>• Tényleges beltéri hőmérséklet</li> <li>• Légh Kondicionálás módja</li> <li>• Szellőzőventilátor fordulatszáma</li> <li>• Aktív kiegészítő funkciók szimbólumai</li> <li>• Akkumulátorállapot</li> </ul>
	Bekapcsolja vagy készenléti módba kapcsolja a tetőklima-berendezést.
	növeli a pillanatnyilag kijelzett értéket.
	csökkenti a pillanatnyilag kijelzett értéket.
	Kiválasztja a ventilátor fordulatszámát (Ventilátor fordulatszám kézi kiválasztása 424. oldal).
	Kiválasztja a légh Kondicionálás módját (Légh Kondicionálási üzemmódok (csak a következő modelleknél: FJX4233EEH/FJX4333E(EH)/FJX7333IHP/FJX7337IHP/FJX7457IHP) 420. oldal). A megfelelő szimbólum jelenik meg.
	Aktiválja az alvás funkciót (További funkciók (csak a következő modelleknél: FJX4233EEH/FJX4333E(EH)/FJX7333IHP/FJX7337IHP/FJX7457IHP) 420. oldal). Megjelenik a  szimbólum.
	Megerősíti és elmenti a beállításokat.
	Beállítja az időzítőt és az órát.
	Be- vagy kikapcsolja a levegőelosztó doboz térvilágítását.
	Az aktuális belső hőmérséklet megjelenítéséhez nyomja meg egyszer. Megjelenik a  szimbólum. A beállított hőmérséklet megjelenítéséhez nyomja meg kétszer.
	Aktiválja az I feel funkciót. Megjelenik a  szimbólum. 10 min időközönként az I feel funkció a célhőmérsékletet a távirányító által mért tényleges hőmérséklethez igazítja.
	Be- vagy kikapcsolja a tetőegység térvilágítását.
	Megjeleníti, hogy a távirányító elemei lemerültek. Cserélje ki az elemeket (Elemek cseréje a távirányítóban 427. oldal).
	Megjeleníti, hogy a távirányító értékeket továbbít a tetőklima-berendezésnek.





## 7.5 Léghűtés üzemmódok (csak FJX4233M)

A tetőklíma-berendezés a következő léghűtési módokkal rendelkezik:

Léghűtés módja	Megjelölt szimbólumok	Leírás
Hűtés		Ön meghatározza a hőmérsékletet és a ventilátor beállításait, a tetőklíma-berendezés pedig erre a hőmérsékletre hűti le a belső teret.
Szellőztetés		Ön megadja a ventilátor beállításait, és a tetőklíma-berendezés fűtés vagy hűtés nélkül keringeti a levegőt.





## 7.6 Léghűtési üzemmódok (csak a következő modelleknél: FJX4233EEH/FJX4333E(EH)/FJX7333IHP/FJX7337IHP/FJX7457IHP)

A tetőklíma-berendezés a következő léghűtési módokkal rendelkezik:

Léghűtés módja	Megjelölt szimbólumok	Leírás
Automatikus	<b>A</b>	Ön meghatározza a hőmérsékletet, és a tetőklíma-berendezés fűtés vagy hűtés által és a szükséges ventilátorsebesség szabályozásával eléri ezt a beltéri hőmérsékletet.
Hűtés		Ön meghatározza a hőmérsékletet és a ventilátor beállításait, a tetőklíma-berendezés pedig erre a hőmérsékletre hűti le a belső teret.
Melegítés		<b>Az FJX4333E modellre nem vonatkozik:</b> Ön meghatározza a hőmérsékletet és a ventilátor beállításait, a tetőklíma-berendezés pedig erre a hőmérsékletre melegíti fel a belső teret. A ventilátor csak 2 min elteltével indul el (alacsony sebességen), majd körülbelül 5 min elteltével áll be a beállított ventilátorsebességre (miután az elpárologtató elérte a megfelelő hőmérsékletet).
Szellőztetés		Ön megadja a ventilátor beállításait, és a tetőklíma-berendezés fűtés vagy hűtés nélkül keringeti a levegőt.
Páramentesítés		A tetőklíma-berendezés a belső tér fűtése vagy hűtése nélkül távolítja el a nedvességet a levegőből, csökkentve ezáltal a levegő relatív páratartalmát.
Levegőtisztító		<b>Az FJX4333E modellre nem vonatkozik:</b> A tetőklíma-berendezés ionizálja a levegőt, így összegyűjti a levegőből a port és a részecskéket, beleértve a vírusokat és baktériumokat is.

## 7.7 További funkciók (csak a következő modelleknél: FJX4233EEH/FJX4333E(EH)/FJX7333IHP/FJX7337IHP/FJX7457IHP)

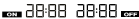
A tetőklíma-berendezés a következő kiegészítő funkciókkal rendelkezik:

Kiegészítő funkció	Kijelzőüzenet	Leírás
Időzítő		A tetőklíma-berendezés a beállított időpontban bekapcsol.
		A tetőklíma-berendezés a beállított időpontban kikapcsol.
		A tetőklíma-berendezés a beállított időpontokban be-, majd újból kikapcsol.
Alvás		Az alvás funkció csökkenti a kompresszor és a ventilátor sebességét, így a kényelmesebb alvás elősegítése érdekében csökkenti a zajszintet.
I Feel		A távirányító méri a helyiség hőmérsékletét, és ezt a mérést 10 min percenként továbbítja a tetőklíma-berendezésnek. A tetőklíma-berendezés ehhez a méréshez igazítja a célértéket.
Lágyindítás		<b>Az FJX4233EEH modellre nem vonatkozik:</b> A kompresszor indításakor keletkező csúcsáramot a lágyindítás funkció csökkenti. Ha áramforrásként generátort használ, a generátor nem terhelődik túl.

## 8 Az első használat előtt

### Az üzembe helyezés előtti ellenőrzések

A tetőklíma-berendezés bekapcsolása előtt vegye figyelembe a következőket:

- Ellenőrizze, hogy a tápfeszültség és a frekvencia megfelel-e az itt megadott értékeknek: Műszaki adatok 434. oldal .
- Biztosítsa, hogy a levegőbeszívó nyílás és a légbefúvók is szabadok legyenek. Mindig tartsa szabadon az összes szellőzőrácsot, ezáltal biztosítva, hogy a tetőklíma-berendezés maximális teljesítménnyel üzemelhesen.

**Készítse elő a távirányítót (csak a következő modelleknél: FreshJet FJX4233EEH/FJX4333E(EH)/FJX7333IHP/FJX7337IHP/FJX7457IHP)**

- Helyezze be az elemeket (Elemek cseréje a távirányítóban 427. oldal).

**Állítsa be az időt (csak a következő modelleknél: FreshJet FJX4233EEH/FJX4333E(EH)/FJX7333IHP/FJX7337IHP/FJX7457IHP)**

- Állítsa be az aktuális időt (Az aktuális idő beállítása 424. oldal).

## 9 Üzemeltetés

### 9.1 A hatékonyabb használatot elősegítő javaslatok

Az alábbi javaslatok optimalizálják a tetőklíma-berendezés teljesítményét:

- A jármű hőszigetelésén a hézagok szigetelésével, illetve az ablakok hővisszaverő árnyékolókkal vagy függönyökkel való eltakarásával javíthat.
- Válasszon megfelelő hőmérsékletet és ventilátorfokozatot.

- Átgondoltan igazítsa be a légbefúvókat.
- Ügyeljen arra, hogy a fúvókákat és a levegőbeszívó nyílásokat ne takarják le kendők, papírok vagy más tárgyak.
- **Csak a következő modelleknél: FreshJet FJX4233EEH/FJX4333E(EH)/FJX7333IHP/FJX7337IHP/FJX7457IHP:** Ha a jármű hosszabb ideig közvetlen napsugárzásnak van kitéve: Egy ideig nyitott ablakoknál, Szellőztetés (🌀) módban üzemeltesse a tetőklíma-berendezést, mielőtt bekapcsolja a Hűtés (❄️) módot.
- **Csak a következő modelleknél: FreshJet FJX4233EEH/FJX4333E(EH)/FJX7333IHP/FJX7337IHP/FJX7457IHP:** Amennyire lehet, Hűtés (❄️) üzemmód közben mellőzze az ajtók és ablakok nyitását.

## 9.2 A kezelésre vonatkozó alapvető megjegyzések

A FreshJet FJX4233M tetőklíma-berendezés három üzemmóddal rendelkezik:

Üzemmód	Leírás
Ki	A tetőklíma-berendezés ki van kapcsolva.
Hűtés	A tetőklíma-berendezés lehűti a belső teret.
Szellőztetés	A tetőklíma-berendezés hűtés nélkül keringeti a levegőt.

A FreshJet FJX4233EEH/FJX4333E(EH)/FJX7333IHP/FJX7337IHP/FJX7457IHP tetőklíma-berendezés két üzemmóddal rendelkezik:

Üzemmód	Leírás
Készenlét	A tetőklíma-berendezés üzemkész és a távirányítóval bekapcsolható. Rendelkezésre állnak a térvilágítások. A távirányító is készenléti állapotban van, de a távirányítót a tetőklíma-berendezéstől függetlenül is bekapcsolhatja.
Be	A tetőklíma-berendezés a belső tér légkondicionálását végzi.

## 9.3 Dometic FJX4233M

Az adott információ ebben a fejezetben csak az FJX4233M tetőklíma-berendezés modellre vonatkozik.

### 9.3.1 A tetőklíma-berendezés be- és kikapcsolása

A tetőklíma-berendezés két légkondicionálás üzemmóddal rendelkezik:

- Szellőztetés (🌀) üzemmód
- Hűtés (❄️) mód



**Megjegyzés** Mielőtt szellőztetés üzemmódról hűtés üzemmódra vagy fordítva váltana, várjon legalább 30 s másodpercet. Ellenkező esetben a kapcsolási áram kiégetheti a biztosítékot.

Mindegyik üzemmód három beállítással rendelkezik:

- .: Alacsony

- ...: Közepes
- ...: Magas
- >

A bekapcsoláshoz fordítsa a  gombot a Szellőztetés () vagy a Hűtés () üzemmód állásba, és válassza ki a kívánt beállítást.

- ✓ A tetőklima-berendezés bekapcsolás előtt beállított értékekkel üzemel.

>

Kikapcsoláshoz fordítsa a  gombot a 0 állásba.

### 9.3.2 A hőmérséklet beállítása

>

Fordítsa a  gombot a kívánt pozícióba. A gomb elforgatása az óramutató járásával megegyező irányban hűvösebb hőmérsékletet jelent.

- ✓ A tetőklima-berendezésen beállításra kerül a hőmérséklet.

## 9.4 Freshjet FJX4233EEH/FJX4333E(EH)/FJX7333IHP/FJX7337IHP/FJX7457IHP

Az adott információ ebben a fejezetben csak a következő modellekre vonatkozik: Freshjet FJX4233EEH/FJX4333E(EH)/FJX7333IHP/FJX7337IHP/FJX7457IHP tetőklima-berendezések.

### 9.4.1 A távirányítóval



A távirányító használatakor vegye figyelembe a következő tanácsokat:

- A távirányítót irányítsa a vezérlőpanel IR-vevőjére.
  - Amikor megnyom egy gombot, a megfelelő beállítások és értékek közvetlenül a tetőklima-berendezéshez kerülnek továbbításra.
  - A tetőklima-berendezés az adatok fogadását hangjelzéssel nyugtázza.
  - Az értékek gyorsabban nőnek vagy csökkennek, ha nyomva tartja a + vagy – gombot.
  - Készenléti üzemmódban a távirányító kijelzője szintén inaktív. A távirányítót a tetőklima-berendezéstől függetlenül készenléti állapotba kapcsolhatja.
- > Ha csak a távirányítót szeretné készenléti állapotba kapcsolni vagy készenléti állapotból bekapcsolni, nyomja meg a  gombot, miközben nem a vezérlőpanel IR-vevőjére mutat.

### 9.4.2 A tetőklima-berendezés bekapcsolása és készenléti állapotba kapcsolása



**Megjegyzés** Ha a tetőklima-berendezés be van kapcsolva, akkor a készenléti állapotba kapcsolás előtt beállított értékekkel üzemel. A tetőklima-berendezés csak az áramellátás megszakításával kapcsolható ki.

- > A tetőklima-berendezés bekapcsolásához vagy készenléti állapotba kapcsolásához nyomja meg a távirányítón lévő  gombot vagy a kezelőpanelen lévő  gombot.

### 9.4.3 A klímamód kiválasztása

- > A MODE gomb (Légkondicionálási üzemmódok (csak s következő modelleknél: FJX4233EEH/FJX4333E(E-H)/FJX7333IHP/FJX7337IHP/FJX7457IHP) 420. oldal ) használatával válassza ki a kívánt légkondicionálás üzemmódot.
- ✓ A tetőklíma-berendezés hangjelzéssel nyugtázza az értékek fogadását. A tetőklíma-berendezés a kiválasztott légkondicionálási módba kapcsol.

### 9.4.4 Ventilátor fordulatszám kézi kiválasztása

Az Automatikus (A) és a Páramentesítés (☉) üzemmód kivételével minden üzemmódban kézzel is kiválasztható a ventilátor fordulatszáma.

Kijelzőüzenet	Leírás
	Alacsony ventilátor fokozat
	Közepes ventilátor fokozat
	Magas ventilátorszint.
	Turbó ventilátorszint.
	Automatikus üzemmód (a ventilátor sebessége a környezeti hőmérséklet alapján kerül beállításra).

- > A kívánt ventilátor fordulatszám kiválasztásához nyomja meg a távirányító (⊗) gombját vagy a vezérlőpanel (⊗) gombját.
- ✓ A tetőklíma-berendezés hangjelzéssel nyugtázza az értékek fogadását.  
Beállításra kerül a ventilátor új sebessége.

### 9.4.5 A hőmérséklet beállítása

Az Automatikus (A), a Hűtés (❄️), a Fűtés (☀️) és a Páramentesítés (☉) üzemmódban 16 °C és 31 °C közötti hőmérsékletet adhat meg.

- > A távirányító + vagy – gombjával állítsa be a kívánt hőmérsékletet.
- ✓ A tetőklíma-berendezés egy magas hanggal nyugtázza az értékek fogadását. A tetőklíma-berendezésen beállításra kerül a hőmérséklet.

### 9.4.6 Az aktuális idő beállítása

A távirányítónak az időzítő programozásához szüksége van a pontos időre. Az idő megjelenik a távirányító kijelzőjén.

1. Az idő beállítás módba történő belépéshez nyomja meg és tartsa lenyomva a (⊕) gombot.
- ✓ Az idő a távirányító kijelzőjén villogva jelenik meg.
2. A + vagy a – gombbal állítsa be az aktuális időt. Az idő gyorsabb növeléséhez vagy csökkentéséhez nyomja meg és tartsa lenyomva a + vagy – gombot 2 s-nél hosszabb ideig.
3. Nyomja meg a SET gombot a pontos idő nyugtázásához.

















### 9.4.7 Az időzítő programozása

Az időzítővel tetszőleges időszakot állíthat be a légkondicionáláshoz. Megadhatja a bekapcsolási időt, a bekapcsolás-készenléti időt vagy mindkét értéket.

Az időzítő funkciót a távirányítóval lehet beállítani.



**Megjegyzés** Ha az időzítő programozása közben 15 s ideig nem nyomja meg a távirányítón lévő gombot, akkor a távirányító visszatér a kezdeti üzemmódba.







- > A következő módon állítsa be a **bekapcsolási időzítőt**:
  - a) Válassza ki a kívánt légkondicionálás üzemmódot és az összes szükséges értéket (például a hőmérsékletet).
  - b) Szükség esetén kapcsolja a tetőklíma-berendezést készenléti állapotba.  
A bekapcsolási időzítő csak akkor állítható be, ha a tetőklíma-berendezés **készenléti állapotban** van.
  - c) Nyomja meg egyszer a  gombot.
  - ✓ A távirányító kijelzőjén villog a  szimbólum.
  - d) A + vagy – gombbal állítsa be azt az időpontot, amikor a tetőklíma-berendezésnek be kell kapcsolnia.
  - e) Nyomja meg a  gombot.  
Megtörtént a bekapcsolási időzítő beállítása. A tetőklíma-berendezés a kiválasztott légkondicionáló üzemmódban fog bekapcsolni a megadott időpontban.
- > Állítsa be a **készenléthez kapcsolási időzítőt** az alábbiak szerint:
  - a) Szükség esetén kapcsolja be a tetőklíma-berendezést.  
A készenléthez kapcsolási időzítő csak akkor állítható be, ha a tetőklíma-berendezés **be** van kapcsolva.
  - b) Nyomja meg kétszer a  gombot.
  - ✓ A távirányító kijelzőjén villog a  szimbólum.
  - c) A + vagy – gombbal állítsa be azt az időpontot, amikor a tetőklíma-berendezés készenléti állapotba kapcsol.
  - d) Nyomja meg a  gombot.  
Megtörtént a készenléti állapotba kapcsolás időzítőjének beállítása. A tetőklíma-berendezés a megadott időpontban készenléti állapotba kapcsol.
- > Állítsa be a **bekapcsolási időzítőt** és a **készenléthez kapcsolási időzítőt** az alábbiak szerint:
  - a) Válassza ki a kívánt légkondicionálás üzemmódot és az összes szükséges értéket (például a hőmérsékletet).
  - b) Nyomja meg háromszor a  gombot.
  - ✓ A távirányító kijelzőjén megjelenik a   szimbólum. A BE szimbólum villog.
  - c) A + vagy – gombbal állítsa be azt az időpontot, amikor a tetőklíma-berendezésnek be kell kapcsolnia.
  - d) Nyomja meg a  gombot.
  - ✓ Az **OFF** szimbólum villog.
  - e) A + vagy – gombbal állítsa be azt az időpontot, amikor a tetőklíma-berendezés készenléti állapotba kapcsol.
  - f) Nyomja meg a  gombot.
  - ✓ Megtörtént a bekapcsolási és a készenléti állapotba kapcsolási idő beállítása. A tetőklíma-berendezés a megadott időtartamra bekapcsol.
- > Az előre beállított időzítés **visszavonásához** nyomja meg egyszer a  gombot.
- ✓ Eltűnik a   szimbólum. Az előre beállított értékek elvetésre kerülnek.

### 9.4.8 Az alvás funkció beállítása

Az alvás funkció csak a Hűtés (❄️) vagy a Fűtés (☀️) üzemmódban érhető el.

A könnyebb alváshoz a zajszint csökkentése érdekében az alvás funkció a ventilátor fordulatszámát alacsonyabb szintre korlátozza.

**Csak a következő modelleknél: FJX7333IHP/FJX7337IHP/FJX7457IHP:** Az alvás funkció a kompresszor fordulatszámát is korlátozza.

- > Az alvás funkció aktiválásához a következőképpen járjon el:
  - a) Állítsa be a kívánt hőmérsékletet (A hőmérséklet beállítása 424. oldal).
  - b) Nyomja meg a  gombot a távirányítón vagy a  gombot a kezelőpanelen.
- ✓ Megjelenik a  szimbólum a távirányító kijelzőjén. Aktiválta az alvás funkciót.
- > Az alvás funkció kikapcsolásához nyomja meg a  vagy a  gombot a távirányítón vagy a  gombot a vezérlőpanelen.
- ✓ A  szimbólum eltűnik a távirányító kijelzőjéről. Az alvás funkció ki van kapcsolva.

### 9.4.9 Az I feel funkció aktiválása

Ennél a funkciónál a távirányító méri a beltéri hőmérsékletet és 10 percenként elküldi a mérési értéket a tetőklíma-berendezésnek. A tetőklíma-berendezés ehhez a méréshez igazítja a célértéket. Az I feel funkció csak akkor aktív, ha a hőmérséklet +18 °C és +29 °C közötti tartományban van.

A távirányítót ne helyezze a beltér olyan tartományába, amely lényegesen melegebb vagy hidegebb az átlagos beltéri hőmérsékletnél. Nem szabad például a napon vagy a tetőklíma-berendezés előtt hagyni.

Ha a hőmérséklet +29 °C fölé emelkedik vagy +18 °C alá csökken, az I feel funkció kikapcsol. A kijelzőn háromszor felvillan a  szimbólum, majd kikapcsol.

1. Nyomja meg a gombot.
- ✓ Be van kapcsolva az I feel funkció.

A  szimbólum jelenik meg a kijelzőn.

2. Helyezze el a távirányítót úgy, hogy az a vezérlőpanel infravörös vevőjére mutasson. Ellenkező esetben az értékek nem továbbíthatók a tetőklíma-berendezéshez.



### 9.4.10 A térvilágítások kezelése







**FIGYELMEZTETÉS! Sérülés kockázata** A törvény értelmében tilos a külső világítások használata a jármű vezetése közben.

A távirányítón lévő  gomb akkor is aktív, ha a távirányító ki van kapcsolva.

**Csak a következő modelleknél: FreshJet FJX4233EEH/FJX4333E(EH)/FJX7333IHP/FJX7337IHP/FJX7457IHP:**

- > A belső világítás be- vagy kikapcsolásához nyomja meg a  gombot a távirányítón vagy a vezérlőpanelen.
- ✓ Amikor a belső világítás **be** van kapcsolva, a  szimbólum egyszer felvillan a távirányító kijelzőjén.

- > A belső világítások tompításához a következőképpen járjon el:
  - a) Nyomja meg a távirányítón vagy a vezérlőpanelen a  gombot ehhez: 3 s.
  - b) Ha megnyomja a  gombot a távirányítón: Nyomja meg a  gombot a belső világítás 50 % és 100 % érték közötti tompításához.
  - c) Amikor megnyomja a  gombot a vezérlőpanelen: A belső világítás fényereje 50 % és 100 % érték között mozog. Ha elérte a kívánt fényerőt, engedje fel a  gombot.

**Csak a Freshjet FJX7333IHP/FJX7337IHP/FJX7457IHP modelleknél:**

- > A külső világítások be- vagy kikapcsolásához nyomja meg a  gombot a vezérlőpanelen.

### 9.4.11 Elemek cseréje a távirányítóban



**Megjegyzés** A távirányító kijelzője még akkor is világíthat, ha kezdenek lemerülni az elemek. Ha a távirányító alacsony elemfeszültséget jelez, cserélje ki az elemeket.

- > A képen látható módon cserélje ki az elemeket.

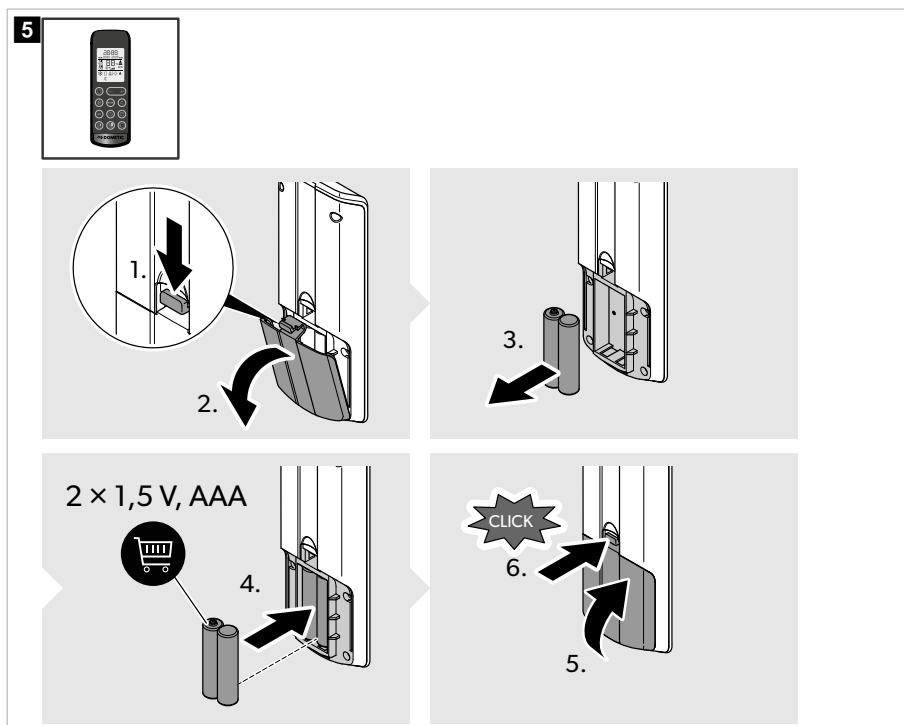

- √ A kijelzőn 5 s másodpercig látható az összes szimbólum.



Védje környezetét! Az akkumulátorok és elemek nem kezelhetők háztartási hulladékként. Adja le a meghibásodott akkumulátorokat vagy elhasznált elemeket a kereskedőnél vagy egy gyűjtőhelyen.

## 9.5 A járművön belüli levegőellátás szabályozása

A légáram a mennyezettel párhuzamosra vagy a padló felé irányítható.

- > A levegő fúvókákban található lemezek külön elfordíthatók a szükséges irányokba.

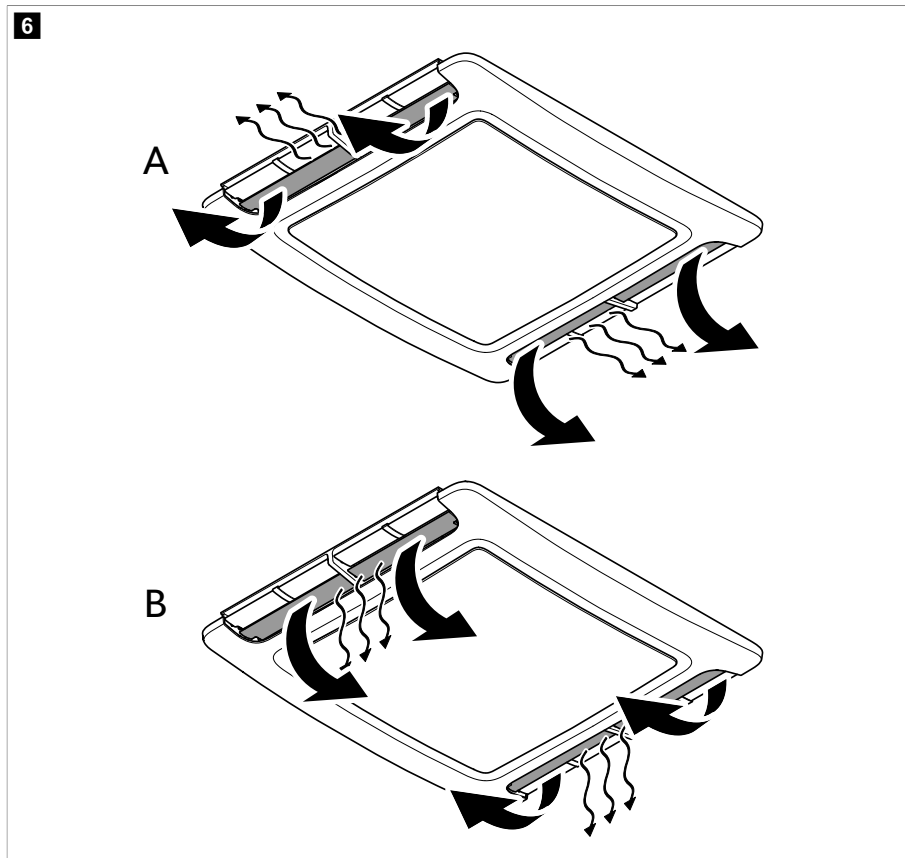

## 10 A tetőklima-berendezés tisztítása



### FIGYELEM! Károsodás veszélye

- A leolvasztás, vagy a tisztítás meggyorsítása érdekében ne használjon más módszereket, mint amelyek a gyártó javasol.
- Ne tisztítsa a tetőklima-berendezést nagynyomású tisztítóval. A behatoló víz a tetőklima-berendezés meghibásodását okozhatja.
- Ne használjon éles vagy kemény tárgyakat vagy tisztítóeszközöket a tisztításhoz, mivel azok a tetőklima-berendezés sérülését okozhatják.
- Ne használjon benzint, gázolajat vagy oldószereket.

1. Rendszeresen távolítsa el a leveleket és egyéb szennyeződések a tetőklima-berendezés levegőbeszívó nyílásaiból és a szellőzőrácsaiból. A művelet során ne károsítsa a szellőzőrácsokat.

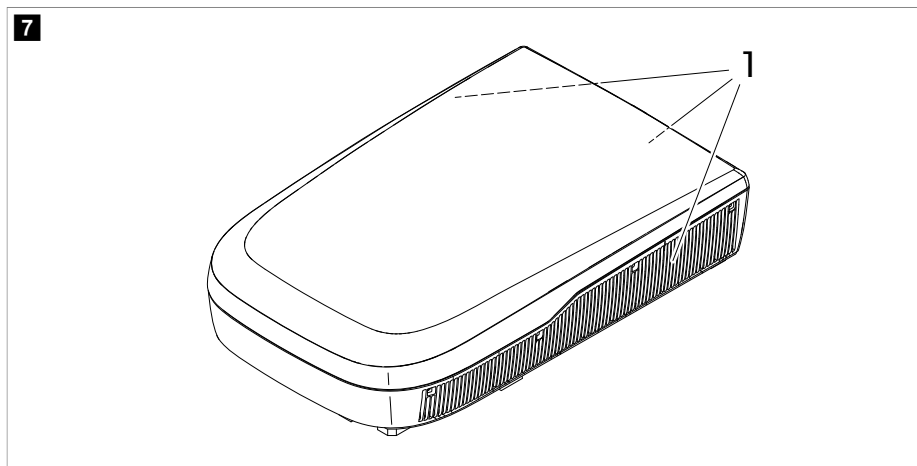

2. Időnként nedves kendővel tisztítsa meg a tetőegység házát és a levegőelosztó dobozt. Csak kímélő tisztítószer vizes oldatát használja.
3. **Csak a következő modelleknél: FreshJet FJX4233EEH/FJX4333E(EH)/FJX7333IHP/FJX7337IHP/FJX7457IHP:** Alkalmanként tisztítsa meg a távirányítót enyhén nedves kendővel. Tisztítsa meg a kijelzőt szemüveg tisztító kendővel.
4. **Csak a következő modelleknél: FreshJet FJX4233EEH/FJX4333E(EH)/FJX7333IHP/FJX7337IHP/FJX7457IHP** Alkalmanként tisztítsa meg a levegőelosztó doboz kijelzőjét langyos szappanos vízből készült kímélő oldattal. A kijelző képernyője akril, és néhány szokványos háztartási vegyszer, például a vegyi tisztítószerek, ablaktisztítók, alkohol, bizonyos tenzidék, szerves oldószerek és lágyítószer károsíthatják ezt.

## 11 Karbantartás

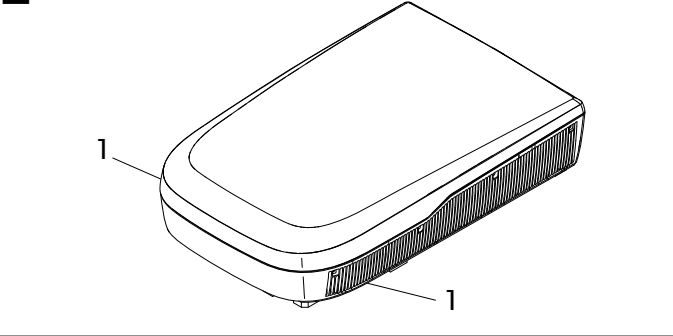
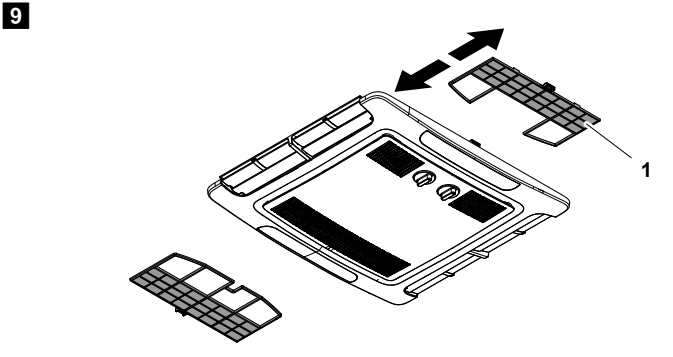

**FIGYELMEZTETÉS! Sérülés kockázata** Az itt leírtaktól eltérő karbantartási munkákat csak a hűtőközegek és klímaberendezések kezelését és a vonatkozó előírásokat ismerő szakemberek végezhetik.

Időköz	Ellenőrzés / karbantartás
Rendszeres	<p data-bbox="333 188 1014 231">Ellenőrizze, hogy a tetőklima-berendezés oldalain található kondenzvíz-elvezető csatornák <b>(1)</b> tiszták-e, és hogy a kondenzvíz el tud-e folyni.</p> <div data-bbox="333 247 1014 616"> <p data-bbox="341 252 367 284"><b>8</b></p>  </div>
Rendszeres (FreshJet FJX4233M)	<p data-bbox="333 643 680 667">Tisztítsa meg a levegőkivezető egység szűrőjét.</p> <div data-bbox="333 683 1014 1045"> <p data-bbox="341 687 367 719"><b>9</b></p>  </div> <ol data-bbox="348 1061 880 1126" style="list-style-type: none"> <li data-bbox="348 1061 540 1085">1. Távolítsa el a szűrőt <b>(1)</b>.</li> <li data-bbox="348 1085 880 1109">2. Tisztítószeres oldattal tisztítsa meg a szűrőt <b>(1)</b> és hagyja megszáradni.</li> <li data-bbox="348 1109 622 1126">3. Helyezze vissza a száraz szűrőt <b>(1)</b>.</li> </ol>

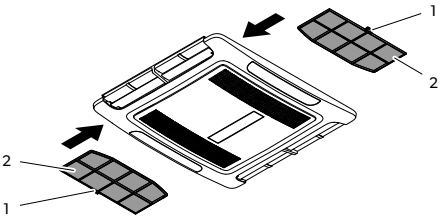
Időköz	Ellenőrzés / karbantartás
Rendszeres (FreshJet FJX4233EEH/FJX4333E(E-H)/FJX7333IHP/FJX7337IHP/FJX7457IHP)	<ul style="list-style-type: none"> <li>Tisztítsa meg a levegőkivezető egység szűrőjét.</li> </ul> <div data-bbox="367 225 1016 528" style="border: 1px solid black; padding: 10px; margin: 10px 0;"> <p><b>10</b></p>  </div> <ol style="list-style-type: none"> <li>1. Illesszen egy lapos csavarhúzó vagy kést a fogantyúba (1), így kissé ki tudja húzni a szűrőket (2).</li> <li>2. Kézzel távolítsa el a szűrőket.</li> <li>3. Tisztítószeres oldattal tisztítsa meg a szűrőket, és hagyja megszáradni ezeket.</li> <li>4. Csúsztassa vissza a száraz szűrőket.. ábra 10 431. oldal</li> </ol> <ul style="list-style-type: none"> <li>Egy erre specializálódott vállalattal végeztesse el a tetőklima-berendezés hőcserélőjének karbantartását.</li> </ul>
Évente egyszer	<ul style="list-style-type: none"> <li>Ellenőrizze a tetőklima-berendezés és a jármű teteje közötti tömítések repedéseit és más sérüléseit.</li> <li>Ellenőrizze, hogy a rögzítőcsavarok a megfelelő nyomatékkal vannak-e meghúzva (2.5 Nm ± 0.3 Nm), és szükség esetén állítsa be ezeket.</li> </ul>

## 12 Hibaelhárítás

Hiba	Lehetséges ok	Megoldási javaslat
Nem jó a hűtés	A tetőklima-berendezés nem hűtésre van állítva.	Állítsa át hűtésre a tetőklima-berendezést.
	A környezeti hőmérséklet 52 °C felett van.	A tetőklima-berendezést csak 52 °C alatti környezeti hőmérsékletekhez tervezték.
	A beállított hőmérséklet magasabb, mint a beltéri hőmérséklet.	Válasszon alacsonyabb hőmérsékletet.
	A környezeti hőmérséklet 16 °C alatt van.	A tetőklima-berendezést kizárólag 16 °C feletti környezeti hőmérsékleteken történő hűtésre tervezték.
	A hőmérséklet-érzékelők egyike meghibásodott.	Vegye fel a kapcsolatot egy hivatalos szervizzel, vagy a Dometic vállalattal.
	A párologtatóventilátor megsérült.	Vegye fel a kapcsolatot egy hivatalos szervizzel, vagy a Dometic vállalattal.

Hiba	Lehetséges ok	Megoldási javaslat
	A kondenzátorventilátor megsérült.	Vegye fel a kapcsolatot egy hivatalos szervizzel, vagy a Dometic vállalattal.
<b>Csak a következő modelleknél:</b> <b>FreshJet FJX4233EEH/FJX4333E(E-H)/FJX7333IHP/FJX7337IHP/FJX7457IHP:</b> Nem jó a fűtés	A tetőklíma-berendezés nem fűtésre van állítva.	Állítsa át fűtésre a tetőklíma-berendezést.
	A környezeti hőmérséklet $-2\text{ °C}$ alatt van.	A tetőklíma-berendezést kizárólag $-2\text{ °C}$ feletti környezeti hőmérséklethez tervezték.
	A beállított hőmérséklet alacsonyabb, mint a beltéri hőmérséklet.	Váltszon magasabb hőmérsékletet.
	A hőmérséklet-érzékelők egyike meghibásodott.	Vegye fel a kapcsolatot egy hivatalos szervizzel, vagy a Dometic vállalattal.
	A párologtatóventilátor megsérült.	Vegye fel a kapcsolatot egy hivatalos szervizzel, vagy a Dometic vállalattal.
Alacsony levegő teljesítmény	A levegőbeszívó nyílások el vannak tömődve vagy torlaszolja.	Távolítsa el a tetőklíma-berendezés szellőzőnyílásainál esetlegesen előforduló leveleket és más szennyeződéseket.
	A ventilátor meghibásodott.	Vegye fel a kapcsolatot egy hivatalos szervizzel, vagy a Dometic vállalattal.
Víz jut be a járműbe.	A kondenzvíz leeresztőnyílásai eldugultak.	Tisztítsa meg a kondenzvíz leeresztőnyílásait.
	A tömítések megsérültek.	Vegye fel a kapcsolatot egy hivatalos szervizzel, vagy a Dometic vállalattal.
A tetőklíma-berendezés nem kapcsol be.	Nincs csatlakoztatva az áramellátás.	Ellenőrizze az áramellátást.
	A feszültség túl alacsony ( $< 200\text{ V}$ ).	Vegye fel a kapcsolatot egy hivatalos szervizzel, vagy a Dometic vállalattal.
	A feszültségátalakító meghibásodott.	Vegye fel a kapcsolatot egy hivatalos szervizzel, vagy a Dometic vállalattal.
	A hőmérséklet-érzékelők egyike meghibásodott.	Vegye fel a kapcsolatot egy hivatalos szervizzel, vagy a Dometic vállalattal.
	Túl kicsi az áramellátás elektromos biztosítója.	Vegye fel a kapcsolatot egy hivatalos szervizzel, vagy a Dometic vállalattal.
A tetőklíma-berendezés nem kapcsol ki.	A hőmérséklet-érzékelők egyike meghibásodott.	Vegye fel a kapcsolatot egy hivatalos szervizzel, vagy a Dometic vállalattal.
	Túl kicsi az áramellátás elektromos biztosítója.	Vegye fel a kapcsolatot egy hivatalos szervizzel, vagy a Dometic vállalattal.
<b>Csak a következő modelleknél:</b> <b>FreshJet FJX4233EEH/FJX4333E(E-H)/FJX7333IHP/FJX7337IHP/FJX7457IHP:</b> A tetőklíma-berendezés folyamatosan kikapcsol.	A jegesedésérzékelő bekapcsol.	Túl alacsony a kültéri hőmérséklet, vagy az összes levegő fűvóka zárva van.



Hiba	Lehetséges ok	Megoldási javaslat
A kijelzőn az alábbi jelenik meg: P0	Túl magas hőmérséklet vagy túláram az IPM modulon	Vegye fel a kapcsolatot egy hivatalos szervizzel, vagy a Dometic vállalattal.
A kijelzőn az alábbi jelenik meg: P1	Túl alacsony feszültség elleni védelem	Vegye fel a kapcsolatot egy hivatalos szervizzel, vagy a Dometic vállalattal.
A kijelzőn az alábbi jelenik meg: P2	Egység váltakozó áramú túláramvédelme	Vegye fel a kapcsolatot egy hivatalos szervizzel, vagy a Dometic vállalattal.
A kijelzőn az alábbi jelenik meg: P4	Kífúvósó túlmelegedés elleni védelme	Vegye fel a kapcsolatot egy hivatalos szervizzel, vagy a Dometic vállalattal.
A kijelzőn az alábbi jelenik meg: P5	Párolgatótekerics védelem (hűtés üzemmód)	Vegye fel a kapcsolatot egy hivatalos szervizzel, vagy a Dometic vállalattal.
A kijelzőn az alábbi jelenik meg: P6	Kondenzátor-tekerics védelem (hűtés üzemmód)	Vegye fel a kapcsolatot egy hivatalos szervizzel, vagy a Dometic vállalattal.
A kijelzőn az alábbi jelenik meg: P7	Párolgatótekerics védelem (fűtés üzemmód)	Vegye fel a kapcsolatot egy hivatalos szervizzel, vagy a Dometic vállalattal.
A kijelzőn az alábbi jelenik meg: P9	A kompresszor hajtása rendellenes vagy a kompresszor nem indul el	Vegye fel a kapcsolatot egy hivatalos szervizzel, vagy a Dometic vállalattal.
A kijelzőn az alábbi jelenik meg: E0	Kommunikációs hiba	Vegye fel a kapcsolatot egy hivatalos szervizzel, vagy a Dometic vállalattal.
A kijelzőn az alábbi jelenik meg: E1	Helyiség-hőmérséklet-érzékelő hiba	Vegye fel a kapcsolatot egy hivatalos szervizzel, vagy a Dometic vállalattal.
A kijelzőn az alábbi jelenik meg: E2	A párolgatótekerics hőmérséklet-érzékelő hiba	Vegye fel a kapcsolatot egy hivatalos szervizzel, vagy a Dometic vállalattal.
A kijelzőn az alábbi jelenik meg: E3	A kondenzátor tekerics hőmérséklet-érzékelő hiba	Vegye fel a kapcsolatot egy hivatalos szervizzel, vagy a Dometic vállalattal.
A kijelzőn az alábbi jelenik meg: E7	Kültéri hőmérséklet-érzékelő hiba	Vegye fel a kapcsolatot egy hivatalos szervizzel, vagy a Dometic vállalattal.
A kijelzőn az alábbi jelenik meg: E8	Kífúvósó-hőmérséklet-érzékelő hiba	Vegye fel a kapcsolatot egy hivatalos szervizzel, vagy a Dometic vállalattal.
A kijelzőn az alábbi jelenik meg: E9	Kompresszor hajtás vagy IPM modul hiba	Vegye fel a kapcsolatot egy hivatalos szervizzel, vagy a Dometic vállalattal.
A kijelzőn az alábbi jelenik meg: EA	Áramérzékelő hiba	Vegye fel a kapcsolatot egy hivatalos szervizzel, vagy a Dometic vállalattal.
A kijelzőn az alábbi jelenik meg: EE	Kültéri EEPROM hiba	Vegye fel a kapcsolatot egy hivatalos szervizzel, vagy a Dometic vállalattal.
A kijelzőn az alábbi jelenik meg: EL	LIN-BUS/CI-BUS kommunikációs hiba	Vegye fel a kapcsolatot egy hivatalos szervizzel, vagy a Dometic vállalattal.

## 13 Ártalmatlanítás



A csomagolóanyagot lehetőség szerint a megfelelő szelektív hulladékgyűjtő tartályokba kell helyezni. A termékre vonatkozó ártalmatlanítási előírásokról tájékozódjon a legközelebbi újrahasznosító központban, vagy szakkereskedőjénél.



Védje környezetét! Az akkumulátorok és elemek nem kezelhetők háztartási hulladékként. Adja le a meghibásodott akkumulátorokat vagy elhasznált elemeket a kereskedőnél vagy egy gyűjtőhelyen.

## 14 Szavatosság

A termékre a törvény szerinti szavatossági időszak érvényes. Amennyiben a termék hibás, lépjen kapcsolatba a gyártó helyi képviselőjével (lásd: [dometic.com/dealer](http://dometic.com/dealer)) vagy a kereskedővel.

A javításhoz, illetve a garancia adminisztrációhoz a következő dokumentumokat kell mellékelnie a termék beküldésekor:

- A számla vásárlási dátummal rendelkező másolatát
- A reklamáció okát vagy a hibát tartalmazó leírást

Vegye figyelembe, hogy az önkezü javítás vagy a nem szakszerű javítás biztonsági következményekkel járhat, és érvénytelenítheti a szavatosságot.

## 15 Műszaki adatok

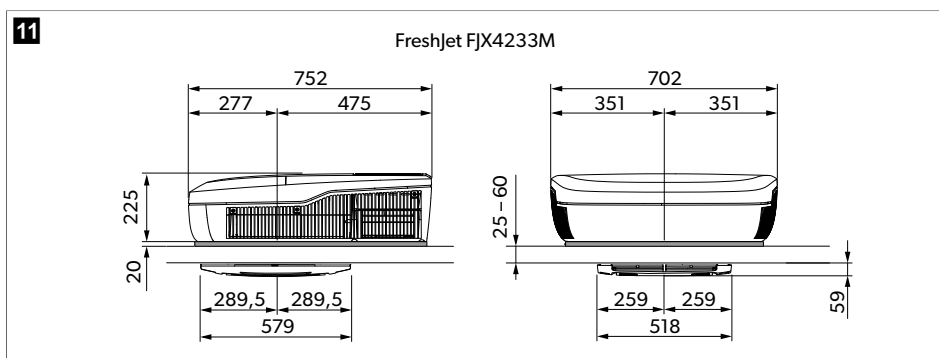

12

FJX4233EEH, FJX4333E(EH), FJX7333IHP

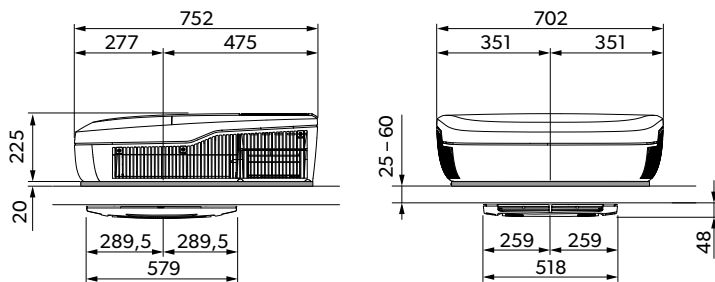

13

FreshJet FJX7337IHP

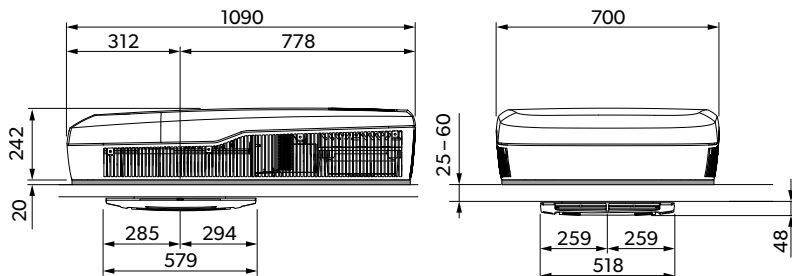

14

FreshJet FJX7457IHP

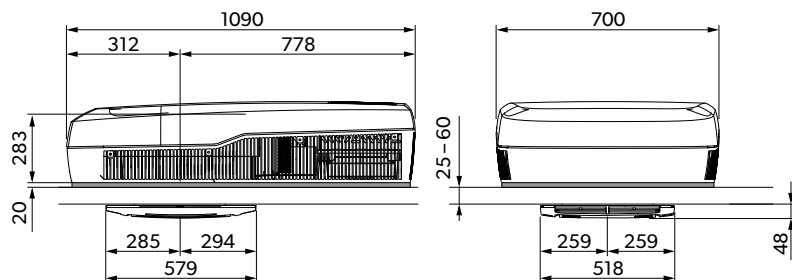

Fluorozott üvegházhatású gázokat tartalmaz. Hermetikusan zárt berendezés.

	<b>FreshJet FJX4233M</b>
Hűtőteljesítmény (ISO 5151 szerint):	1500 W
Váltakozó áramú bemeneti feszültség:	220 V ... 240 V / 50 Hz

	<b>FreshJet FJX4233M</b>
Hűtés névleges áramerőssége:	< 3.3 A
Szükséges biztosíték:	4 A
Üzemelési hőmérséklet-tartomány:	- 2 °C ... 52 °C
Hűtőközeg:	R410a
Hűtőközeg mennyisége:	380 g
CO <sub>2</sub> egyenérték:	0.793 t
Üvegház-potenciál (GWP):	2088
Védelmi osztály (tetőegység):	IPX4
Zajszint (legmagasabb ventilátor-beállítás)	< 70 dB(A)
Javasolt max. járműhossz (szigetelt falakkal):	< 5 m
Méretek (H x Sz x Ma):	. ábra <b>11</b> 434. oldal
Súly:	< 30 kg
Vizsgálat/tanúsítvány:	

	<b>FreshJet FJX4233EEH</b>	<b>FreshJet FJX4333EEH</b>	<b>FreshJet FJX4333E</b>
Hűtőteljesítmény (ISO 5151 szerint):	1700 W	2200 W	2200 W
Fűtési teljesítmény az ISO 5151 szabvány alapján:	800 W	1000 W	-
Váltakozó áramú bemeneti feszültség:	220 V ... 240 V / 50 Hz		
Hűtés névleges áramerőssége:	3.6 A	4.8 A	4.8 A
Fűtés névleges áramerőssége:	< 5.2 A	< 5.2 A	-
Szükséges biztosíték:	4 A	5 A	6 A
Üzemelési hőmérséklet-tartomány:	- 2 °C ... 52 °C		
Hűtőközeg:	R32		

	<b>FreshJet FJX4233EEH</b>	<b>FreshJet FJX4333EEH</b>	<b>FreshJet FJX4333E</b>
Hűtőközeg mennyisége:	320 g	360 g	360 g
CO <sub>2</sub> egyenérték:	0,216 t	0,243 t	0,243 t
Üvegház-potenciál (GWP):		675	
Védelmi osztály (tetőegység):		IPX4	
Zajszint (legmagasabb ventilátor-beállítás)		< 70 dB(A)	
Javasolt max. járműhossz (szigetelt falakkal):	< 6 m	< 7 m	< 7 m
Méreték (H x Sz x Ma):		. ábra <b>12</b> 435. oldal	
Súly:	< 30 kg	< 30 kg	< 30 kg
Vizsgálat/tanúsítvány:			

	<b>FreshJet FJX7333IHP</b>	<b>FreshJet FJX7337IHP</b>	<b>FreshJet FJX7457IHP</b>
Hűtőteljesítmény (ISO 5151 szerint):	2200 W	3000 W	3500 W
Fűtési teljesítmény az ISO 5151 szabvány alapján:	2000 W	2500 W	3000 W
Váltakozó áramú bemeneti feszültség:	220 V ... 240 V / 50 Hz ... 60 Hz	220 V ... 240 V / 50 Hz ... 60 Hz	220 V ... 240 V / 50 Hz ... 60 Hz
Hűtés névleges áramerőssége:	< 7.5 A	< 7.5 A	< 7.5 A
Fűtés névleges áramerőssége:	< 6.1 A	< 6.1 A	< 6.1 A
Szükséges biztosíték:	6 A	6 A	6 A
Üzemelési hőmérséklet-tartomány:	- 2 °C ... 52 °C	- 2 °C ... 52 °C	- 2 °C ... 52 °C
Hűtőközeg:	R32	R32	R32
Hűtőközeg mennyisége:	420 g	480 g	650 g
CO <sub>2</sub> egyenérték:	0,2835 t	0,3240 t	0,43875 t
Üvegház-potenciál (GWP):		675	
Védelmi osztály (tetőegység):		IPX4	
Zajszint (legmagasabb ventilátor-beállítás)		< 70 dB(A)	

	<b>Freshjet FJX7333IHP</b>	<b>Freshjet FJX7337IHP</b>	<b>Freshjet FJX7457IHP</b>
Javasolt max. járműhossz (szigetelt falakkal):	< 7 m	< 7 m	> 8 m
Méretetek (H x Sz x Ma):	. ábra <b>12</b> 435. oldal	. ábra <b>13</b> 435. oldal	. ábra <b>14</b> 435. oldal
Súly:	< 30 kg	< 35 kg	< 40 kg
Vizsgálat/tanúsítvány:			

## Arabic

439	ملاحظات هامة	1
439	شرح الرموز	2
440	إرشادات السلامة	3
441	الاستخدام المقصود	4
441	شرح الرموز على الجهاز	5
442	الحدود والشروط الفنية	6
442	الوصف التقني	7
448	قبل الاستخدام لأول مرة	8
448	الاستخدام	9
456	تنظيف مكيف هواء السقف	10
456	الصيانة	11
Troubleshooting	458	12
460	التخلص من الجهاز	13
460	الضمان	14
461	البيانات التقنية	15

## 1 ملاحظات هامة

يرجى قراءة هذه التعليمات، والإرشادات، والتحذيرات الواردة في دليل المنتج المشار إليه واتباعها بعناية للتأكد من تركيب المنتج، واستخدامه، وصيافته بشكل صحيح في جميع الأوقات. يجب أن تظل هذه التعليمات مع هذا المنتج.

باستخدام هذا المنتج، فإنك تؤكد بمقتضى ذلك أنك قد قرأت إخلاء المسؤولية المشار إليها، وكافة التعليمات، والإرشادات، والتحذيرات بعناية وأنك تفهم الشروط والأحكام وتوافق على الالتزام بها على النحو المنصوص عليه هنا. كما توافق على استخدام هذا المنتج فقط للغرض والاستعمال المقصود وفقاً للتعليمات، والإرشادات، والتحذيرات على النحو المنصوص عليه في دليل المنتج المشار إليه وكذلك وفقاً لجميع القوانين واللوائح المعمول بها. قد يؤدي عدم قراءة التعليمات والتحذيرات المنصوص عليها في هذه الوثيقة واتباعها إلى حدوث إصابة لك وللآخرين أو تلف منتجك أو تلف الممتلكات الأخرى الموجودة بالقرب منه. قد يخضع دليل المنتج المشار إليه، بما فيه من تعليمات وإرشادات وتحذيرات، والوثائق ذات الصلة للتغيير والتحديث. للحصول على أحدث معلومات عن المنتج، يرجى زيارة [documents.dometic.com](http://documents.dometic.com).

## 2 شرح الرموز

خطر! تشير إلى وجود وضع خطير إذا لم يتم تجنبه، سيؤدي إلى الوفاة أو حدوث إصابة خطيرة.



تنبيه! تشير إلى وجود وضع خطير إذا لم يتم تجنبه، سيؤدي إلى الوفاة أو حدوث إصابة خطيرة.



احتراس! تشير إلى وجود وضع خطير إذا لم يتم تجنبه، يمكن أن يؤدي إلى حدوث إصابات بسيطة أو متوسطة.



تحذير! تشير إلى وجود وضع خطير إذا لم يتم تجنبه، يمكن أن يؤدي إلى حدوث إصابات بسيطة أو متوسطة.



ملاحظة! معلومات تكميلية لتشغيل المنتج.



### 3 إرشادات السلامة



- تنبيه! عدم الالتزام بهذه التحذيرات قد يسفر عنه الوفاة أو التعرض لإصابات خطيرة.
  - **الأجهزة الكهربائية ليست آمنة للأطفال.** لا يجوز استخدام الجهاز من قبل أشخاص (بما في ذلك الأطفال) الذين يعانون من إعاقة جسدية أو حسية أو عقلية أو لديهم نقص بالخبرة والمعرفة، إلا إذا كانوا تحت الإشراف أو بعدما تلقوا التعليمات.
  - يجب الإشراف على الأطفال للتأكد من عدم لعبهم بالجهاز.
  - يمكن استخدام هذا الجهاز من قبل الأطفال الذين تبدأ أعمارهم من سن 8 سنوات والأشخاص الذين يعانون من إعاقة جسدية أو حسية أو عقلية أو لديهم نقص بالخبرة والمعرفة، إذا كانوا تحت الإشراف أو إعطائهم التعليمات المتعلقة باستخدام الجهاز بطريقة آمنة وفهم المخاطر التي تنطوي عليها.
  - لا يُسمح للأطفال القيام بأعمال التنظيف بدون إشراف.
  - يجب على أي شخص يشارك في العمل على دائرة التبريد أو يتدخل فيها، أن يمتلك شهادة سارية المفعول من هيئة تقييم معتمدة في الصناعة والتي تثبت كفاءته بشأن التعامل مع وسيط التبريد وفقاً لمواصفات تقييم معترف بها في الصناعة.
  - يجب إجراء الصيانة فقط على النحو الموصى به من قبل الشركة المصنعة للجهاز. أعمال الصيانة والإصلاح التي تتطلب مساعدة أشخاص مؤهلين آخرين، يجب أن يتم تنفيذها تحت إشراف الشخص المختص في التعامل مع المبردات القابلة للاشتعال.
  - لا يُسمح بإجراء إصلاح الجهاز إلا بواسطة فنيين متخصصين على دراية كافية بالمخاطر واللوائح ذات الصلة. قد تؤدي الإصلاحات غير السليمة إلى التسبب في حدوث مخاطر شديدة. في حالة الحاجة للإصلاح، عليك الاتصال بمركز الخدمة في بلدك (انظر [dometic.com/dealer](http://dometic.com/dealer)).
  - أفضل دائماً مصدر الطاقة عند إجراء عمل على الجهاز.
  - يجب تخزين الجهاز في غرفة لا يوجد فيها مصادر للاشتعال مثل اللهب المكشوف أو جهاز يعمل بالغاز أو سخان كهربائي يعمل باستمرار.
  - يجب عدم ثقب الجهاز أو حرقه.
  - اعلم بأن المبردات لا تحتوي على راحة.
  - لا تستخدم الجهاز بالقرب من السوائل القابلة للاشتعال أو في الغرف المغلقة.
  - تأكد من عدم تخزين أو تركيب أي أشياء قابلة للاشتعال بالقرب من مخرج الهواء. يجب الحفاظ على مسافة لا تقل عن 50 سم.
  - حافظ على فتحات التهوية خالية من العوائق.
  - لا تلمس الضرب بدائرة التبريد.
  - لا يجوز تحت أي ظرف من الظروف استخدام مصادر الاشتعال المحتملة في البحث أو الكشف عن تسربات وسيط التبريد. لا يجوز استخدام شعلة الهالوجين (أو أي كاشف آخر يستخدم اللهب المكشوف).
  - تم تصميم مكيف هواء السقف للتركيب في مركبة تزيد مساحة أرضيتها عن 4 م<sup>2</sup>.
- احتراس! إن عدم الالتزام بهذه التنبيهات يمكن أن يؤدي إلى حدوث إصابات بسيطة أو متوسطة.
- عدم الوصول إلى منافذ التهوية وعدم إدخال أشياء غريبة في الجهاز.
  - في حالة نشوب حريق، لا تقم برك الغطاء العلوي للجهاز. بل استخدم مواد إطفاء معتمدة. لا تستخدم الماء في الإطفاء.
  - في حالة تلف كابل التوصيل، يجب استبداله من قبل الشركة المصنعة أو وكيل خدمة العملاء أو فني متخصص على نفس المستوى من أجل تجنب المخاطر.
  - إذا كان الجهاز يحتوي على موئين، استشر طبيبك إذا كان لديك مرض. يمكن أن ينتج الموزين الأوزون (O3) بكميات صغيرة. إذا كنت تعاني من أمراض الرئة أو الربو أو أمراض القلب أو أمراض الجهاز التنفسي أو مشاكل الجهاز التنفسي أو لديك حساسية من الأوزون، فاستشر طبيبك لتحديد ما إذا كان استخدام الجهاز آمناً لك.





تحذير! خطر التلف



- لا تستخدم أي وسيلة بخلاف تلك الموصى بها من قبل الشركة المصنعة لتسريع عملية إزالة الجليد أو للتنظيف.
- يجب تخزين الجهاز بشكل يمنع حدوث أي تلف ميكانيكي.
- لا تتم بإجراء أي تغييرات أو تعديلات على الجهاز.
- لا تتم أبداً بقيادة السيارة في المغاسل عند تثبيت الجهاز.
- في حالة حدوث عيوب في دائرة التبريد، يجب فحص الجهاز وإصلاحه من قبل الشركة المصنعة أو وكيل خدمة العملاء أو فني متخصص على نفس المستوى من أجل تجنب المخاطر.

## 4 الاستخدام المقصود

تم تصميم مكيف هواء السقف FreshJet FJX فقط للتركيب على سطح كرفان أو مركبة ترفيهية لتوفير التبريد.

مكيف هواء السقف غير مناسب للقطارات والمنازل والشقق السكنية. مكيف هواء السقف غير مناسب للتركيب في آلات البناء أو الآلات الزراعية أو المعدات المماثلة.

هذا المنتج مناسب للغرض المقصود والاستخدام وفقاً للتعليمات هذه فقط.

يوفر دليل التشغيل هذا المعلومات الضرورية للتركيب و/أو التشغيل الصحيح للمنتج. سيؤدي سوء التركيب و/أو التشغيل الخاطئ والصيانة غير الصحيحة إلى أداء غير مرضي وعطل محتمل.

لا تتحمل الشركة المصنعة أي مسؤولية عن أي ضرر أو تلف بالمنتج ناتج عن:

- عملية التجميع أو التوصيل غير الصحيحة بما في ذلك الجهد الزائد
- صيانة غير صحيحة أو استخدام قطع غيار غير أصلية وغير مقدمة من الشركة المصنعة
- إجراء تعديلات على المنتج دون حصول على إذن صريح من الشركة المصنعة
- الاستخدام في أعراض أخرى بخلاف الأعراض الموضحة في هذا الدليل

تحتفظ شركة Dometic بالحق في تغيير شكل المنتج ومواصفاته.

## 5 شرح الرموز على الجهاز

تحذير! مادة ذات سرعة احتراق منخفضة.



اقرأ دليل التشغيل.



اقرأ دليل الخدمة.



## 6 الحدود والشروط الفنية

مكيف هواء السقف مخصص للسيارات ذات الأسقف التي يبلغ سمكها 25 مم ... 60 مم. وظيفة مكيف هواء السقف تضمن درجات الحرارة المحيطة ما بين - 2 درجة مئوية ... 52 درجة مئوية. تم تصميم مكيف هواء السقف ليتم تركيبه في حدود  $\pm 10$  درجة على المستوى الأفقي. قد ينخفض أداء مكيف هواء السقف عندما يتعرض للاهتزازات قوية، على سبيل المثال بسبب ظروف الطريق السيئة.

## 7 الوصف التقني

يعمل مكيف هواء السقف FreshJet FJX4233M على تزويد الجزء الداخلي للسيارة بهواء بارد خالٍ من الغبار والأوساخ ويمكن إزالة الرطوبة منه.

يعمل مكيف هواء السقف FreshJet FJX4233EEH/FJX4333E(EH)/FJX7333IHP/FJX7337IHP/FJX7457IHP على تزويد الجزء الداخلي للسيارة بهواء بارد أو دافئ خالٍ من الغبار والأوساخ ويمكن إزالة الرطوبة منه.

يمكن لمكيف هواء السقف أن يخفض درجة الحرارة داخل السيارة إلى مستوى معين يعتمد على نوع السيارة ودرجة الحرارة المحيطة وقدرة التبريد لمكيف هواء السقف. عندما تكون تحت درجة حرارة خارجية تبلغ أقل من 16 درجة مئوية لم يعد يقوم مكيف هواء السقف بالتبريد.

يعمل مكيف هواء السقف بعناصر التشغيل التالية:

- لوحة التحكم

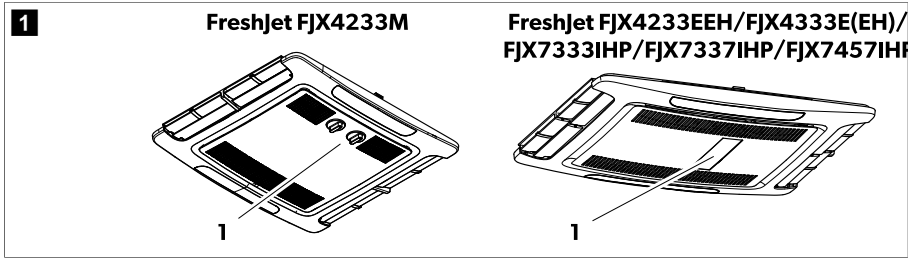

- جهاز التحكم عن بُعد (فقط FJX4233EEH/FJX4333E(EH)/FJX7333IHP/FJX7337IHP/FJX7457IHP)

### 7.1 قائمة النماذج

يوضح الجدول التالي الوظيفة التي تنطبق على نموذج معين:

- الوظيفة متاحة

- الوظيفة قابلة للتحديث

FJX7457IHP	FJX7337IHP	FJX7333IHP	FJX4333E	FJX4333EEH	FJX4233EEH	FJX4233M	
●	●	●	●	●	●		أوتوماتيكي
●	●	●	●	●	●	●	التبريد
●	●	●	○	●	●		التسخين
●	●	●	●	●	●	●	تهوية
●	●	●	●	●	●		تجفيف

FJX7457IHP	FJX7337IHP	FJX7333IHP	FJX4333E	FJX4333EEH	FJX4233EEH	FJX4233M	
●	●	●	○	●	●	○	تنقية الهواء
●	●	●	○	●	●		ضوء ADB
●	●	●					ضوء خارجي
●	●	●	●	●	●		المؤقت
●	●	●	●	●	●		النوم
●	●	●	○	●			بدء التشغيل الخفيف

## 7.2 لوحة تحكم FreshJet FJX4233M

2

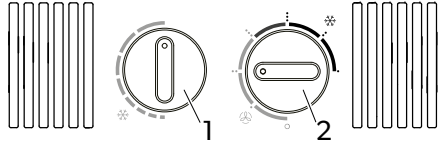

الوصف

مقبض

يختار درجة الحرارة. قم بالإدارة في اتجاه عقارب الساعة لزيادة التبريد.











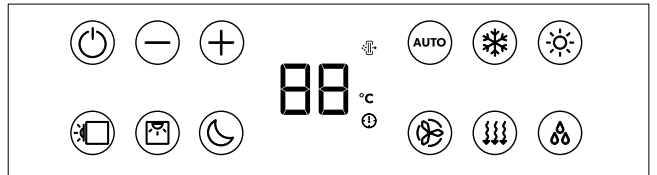

يقوم بتشغيل أو إيقاف مكيف هواء السقف واختيار شدة دوران الهواء في وضع التهوية (⊗) أو شدة التبريد في وضع التبريد (❄️).



## 7.3 لوحة التحكم FreshJet FJX4233EEH/FJX4333E(EH)/FJX7333IHP/FJX7337IHP/FJX7457IHP

3



الوصف	الرمز
يقوم بتشغيل مكيف هواء السقف أو ينتقل إلى وضع الاستعداد.	
يزيد من القيمة المعروضة حالياً.	
يقلل من القيمة المعروضة حالياً.	
يقترن مع بلوتوث/WLAN عند الضغط على كلا الزرين في نفس الوقت.	
يقوم بتشغيل أو إطفاء الأضواء المحيطة في الوحدة العلوية بالسقف.	
يقوم بتشغيل أو إطفاء الأضواء المحيطة في صندوق توزيع الهواء.	
يفعل وظيفة النوم (وظائف إضافية فقط) (فقط FJX4233EEH/FJX4333E(EH)/FJX7333IHP/FJX7337IHP/FJX7457IHP) بالصفحة (447).	
يعرض درجة الحرارة التي تم ضبطها ويشير إلى مستوى المروحة عند تعديلها.	
يشير إلى أن وضع AirPurifier نشط.	
يشير إلى عرض درجة الحرارة بالدرجات المئوية.	
يشير إلى ضبط المؤقت.	
يمكن/يعطل الوضع الأوتوماتيكي (أوضاع تكييف الهواء فقط) (فقط FJX4233EEH/FJX4333E(EH)/FJX7333IHP/FJX7337IHP/FJX7457IHP) بالصفحة (446).	
يمكن/يعطل وضع التبريد (أوضاع تكييف الهواء فقط) (فقط FJX4233EEH/FJX4333E(EH)/FJX7333IHP/FJX7337IHP/FJX7457IHP) بالصفحة (446).	
يمكن/يعطل وضع التسخين (أوضاع تكييف الهواء فقط) (فقط FJX4233EEH/FJX4333E(EH)/FJX7333IHP/FJX7337IHP/FJX7457IHP) بالصفحة (446).	
يضبط سرعة المروحة بين منخفض، معتدل، عالي، سريع أو أوتوماتيكي (انظر 1، 2، 3، 4 أو AA كما هو موضح على شاشة صندوق توزيع الهواء لفترة قصيرة عند التغيير).	
يمكن/يعطل وضع التهوية (أوضاع تكييف الهواء فقط) (فقط FJX4233EEH/FJX4333E(EH)/FJX7333IHP/FJX7337IHP/FJX7457IHP) بالصفحة (446). يوزع الهواء بدون تدفئة أو تبريد.	
يمكن/يعطل وضع التجفيف (أوضاع تكييف الهواء فقط) (فقط FJX4233EEH/FJX4333E(EH)/FJX7333IHP/FJX7337IHP/FJX7457IHP) بالصفحة (446).	

7.4 جهاز التحكم عن بُعد: FreshJet FJX4233EEH/FJX4333E(EH)/FJX7333IHP/FJX7337IHP/FJX7457IHP

4

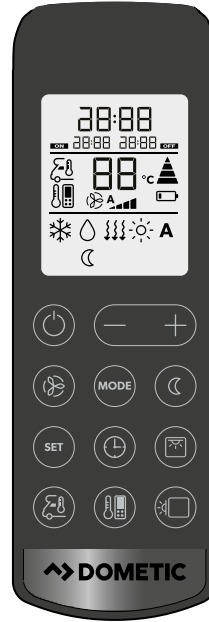

عناصر التحكم والعرض شكل 4 بالصفحة 445:

الوصف	زر
<p>شاشة العرض</p> <p>يتم عرض ما يلي:</p> <ul style="list-style-type: none"> <li>• الوقت</li> <li>• درجة حرارة الغرفة المحددة (القيمة المستهدفة) بالدرجة المنوية</li> <li>• درجة حرارة الغرفة الفعلية</li> <li>• وضع تكييف الهواء</li> <li>• سرعة المروحة</li> <li>• رموز للوظائف الإضافية النشطة</li> <li>• حالة البطارية</li> </ul>	—
يقوم بتشغيل مكيف هواء السقف أو ينتقل إلى وضع الاستعداد.	⏻
يزيد من القيمة المعروضة حالياً.	⊕
يقلل من القيمة المعروضة حالياً.	⊖

الوصف	زر
يحدد سرعة المروحة (اختيار سرعة المروحة يدوياً بالصفحة 450).	
يحدد وضع تكييف الهواء (أوضاع تكييف الهواء فقط) FJX4233EEH/FJX4333E(EH)/FJX7333IHP/FJX7337IHP (فقط) FJX7457IHP بالصفحة 446). يعرض الرمز المعنى.	
يفعل وظيفة النوم (وظائف إضافية فقط) FJX4233EEH/FJX4333E(EH)/FJX7333IHP/FJX7337IHP/FJX7457IHP بالصفحة 447). يعرض الرمز .	
يؤكد ويحزّن الإعدادات.	
يضيّب المؤقت والساعة.	
يقوم بتشغيل أو إطفاء الأضواء المحيطة في صندوق توزيع الهواء.	
اضغط مرة واحدة لعرض درجة الحرارة الداخلية الحالية. يتم عرض الرمز . اضغط مرتين لعرض درجة الحرارة التي تم ضبطها.	
يفعل وظيفة I feel. يتم عرض الرمز . كل 10 دقائق تقوم وظيفة I feel بضبط درجة الحرارة المستهدفة لدرجة الحرارة الفعلية المقاسة بجهاز التحكم عن بُعد.	
يقوم بتشغيل أو إطفاء الأضواء المحيطة في الوحدة العلوية بالسقف.	
يشير إلى أن بطارية جهاز التحكم عن بُعد فارغة. استبدل البطارية (استبدال بطاريات جهاز التحكم عن بُعد بالصفحة 453).	
يشير إلى أن جهاز التحكم عن بُعد يرسل القِيم إلى مكيف هواء السقف.	

## 7.5 وضع تكييف الهواء (فقط FJX4233M)

مكيف هواء السقف له أوضاع تكييف الهواء التالية:

الوصف	الرمز المعروض	وضع تكييف الهواء
عندما تحدد درجة الحرارة وإعدادات المروحة، يقوم مكيف هواء السقف بتبريد الداخل على درجة الحرارة المطلوبة.		التبريد
عندما تحدد إعدادات المروحة، يقوم مكيف هواء السقف بتوزيع الهواء بدون تدفئة أو تبريد.		تهوية

## 7.6 أوضاع تكييف الهواء (فقط FJX4233EEH/FJX4333E(EH)/FJX7333IHP/FJX7337IHP/FJX7457IHP)

مكيف هواء السقف له أوضاع تكييف الهواء التالية:

وضع تكييف الهواء	الرمز المعروض	الوصف
أوتوماتيكي	<b>A</b>	عندما تحدد درجة الحرارة، يقوم مكيف هواء السقف بضبط درجة الحرارة الداخلية على درجة الحرارة المطلوبة عن طريق التنفث أو التبريد من خلال التحكم في سرعة المروحة اللازمة.
التبريد		عندما تحدد درجة الحرارة وإعدادات المروحة، يقوم مكيف هواء السقف بتبريد الداخل. على درجة الحرارة المطلوبة.
التسخين		ليس لـ <b>FJX4333E</b> : عندما تحدد درجة الحرارة وإعدادات المروحة، يقوم مكيف هواء السقف بتدفئة الداخل. على درجة الحرارة المطلوبة. ستبدأ المروحة بعد 2 دقائق فقط (على سرعة منخفضة) ثم بعد حوالي 5 دقائق ستنقل إلى سرعة المروحة المضبوطة (بعد وصول المبخر إلى درجة الحرارة).
تهوية		عندما تحدد إعدادات المروحة، يقوم مكيف هواء السقف بتوزيع الهواء بدون تدفئة أو تبريد.
إزالة الرطوبة		يزيل مكيف هواء السقف الرطوبة من الهواء دون تدفئة أو تبريد الداخل وبالتالي تقليل الرطوبة النسبية للهواء.
تنقية الهواء		ليس لـ <b>FJX4333E</b> : يقوم مكيف هواء السقف على تأين الهواء، وبالتالي يجمع الغبار والجزيئات بما في ذلك الفيروسات والبكتيريا من الهواء.

## 7.7 وظائف إضافية (فقط /FJX7333IHP/FJX7333IHP/FJX4333E/FJX4233EEH/FJX7457IHP)

يحتوي مكيف هواء السقف على الوظائف الإضافية التالية:

وظيفة إضافية	رسائل الشاشة	الوصف
المؤقت		يعمل مكيف هواء السقف في الوقت المحدد.
		يتوقف مكيف هواء السقف في الوقت المحدد.
		يعمل ويتوقف مكيف هواء السقف في الأوقات المحددة.
النوم		تعمل وظيفة النوم على تقليل سرعة المروحة وسرعة المكبس لتقليل مستويات الضوضاء من أجل نوم مريح.
I feel		يقوم جهاز التحكم عن بُعد بقياس درجة حرارة الغرفة وينقل هذا القياس إلى مكيف هواء السقف كل 10 دقائق. يتكيف مكيف هواء السقف مع القيمة المستهدفة لهذا القياس.
بدء التشغيل الخفيف		ليس لـ <b>FJX4233EEH</b> : يتم تقليل تيار الذروة الذي ينتج عن عملية بدء تشغيل المكبس عن طريق وظيفة التشغيل الخفيف. إذا تم استخدام مولد التيار كمصدر للطاقة، فيجب عدم تحميل المولد فوق طاقته.

## 8 قبل الاستخدام لأول مرة

### الفحص قبل بدء التشغيل

قبل تشغيل مكيف هواء السقف، يجب مراعاة ما يلي:

1. تحقق مما إذا كان جهد التيار والتردد يتوافقان مع القيم المحددة في البيانات التقنية بالصفحة 461.
2. تأكد من أن فتحات سحب الهواء وفوهات الهواء خالية. يجب دائما الحفاظ على جميع شبكات التهوية خالية لضمان أن مكيف هواء السقف قادرا على العمل بأقصى قدرة.
3. قم بإعداد جهاز التحكم عن بُعد (فقط FreshJet FJX4233EEH/FJX4333E(EH)/FJX7333IHP/FJX7337IHP/FJX7457IHP)
4. اضبط الوقت (فقط FreshJet FJX4233EEH/FJX4333E(EH)/FJX7333IHP/FJX7337IHP/FJX7457IHP)
4. اضبط الوقت الحالي (ضبط الوقت الحالي بالصفحة 451).

## 9 الاستخدام

### 9.1 نصائح لاستخدام أفضل

تعمل النصائح التالية على تحسين أداء مكيف هواء السقف:

- قم بتحسين العزل الحراري لسيارتك عن طريق سد الفجوات وتركيب ستائر أو ستائر عاكسة على النوافذ.
- اختر درجة حرارة وسرعة مروحة مناسبة.
- قم بتوجيه فوهات الهواء بشكل معقول.
- تأكد من أن فوهات الهواء وفتحات سحب الهواء غير مغطاة بملابس أو أوراق أو غيرها من الأغراض.
- فقط لـ FreshJet FJX4233EEH/FJX4333E(EH)/FJX7333IHP/FJX7337IHP/FJX7457IHP: إذا تعرضت السيارة لأشعة الشمس المباشرة لفترة طويلة: قم بتشغيل مكيف هواء السقف على وضع التهوية (🌀) مع فتح النوافذ لفترة من الوقت قبل تشغيل وضع التبريد (❄️).
- فقط لـ FreshJet FJX4233EEH/FJX4333E(EH)/FJX7333IHP/FJX7337IHP/FJX7457IHP: تجنب فتح الأبواب والنوافذ قدر الإمكان في وضع التبريد (❄️).

### 9.2 ملاحظات أساسية عن التشغيل

يحتوي مكيف هواء السقف FreshJet FJX4233M على ثلاثة أوضاع تشغيل:

وضع التشغيل	الوصف
لا تعمل	مكيف هواء السقف متوقف عن التشغيل.
التبريد	يبرد مكيف هواء السقف من الداخل.
تهوية	يقوم مكيف هواء السقف بتدوير الهواء بدون تبريد.

يحتوي مكيف هواء السقف FreshJet FJX4233EEH/FJX4333E(EH)/FJX7333IHP/FJX7337IHP/FJX7457IHP على وضعين للتشغيل:



وضع التشغيل	الوصف
وضع الاستعداد	مكيف هواء السقف جاهز للتشغيل ويمكن تشغيله باستخدام جهاز التحكم عن بُعد. الأضواء المحيطة متوفرة. جهاز التحكم عن بُعد هو أيضاً في وضع الاستعداد ولكن يمكنك تشغيل جهاز التحكم عن بُعد بشكل مستقل عن مكيف هواء السقف.
On (تشغيل)	يقوم مكيف هواء السقف بتكييف الهواء في الداخل.

### 9.3 مكيفات الهواء على السطح Dometic FJX4233M

المعلومات الواردة في هذا الفصل تنطبق فقط على مكيف هواء السقف FJX4233M.

#### 9.3.1 تشغيل وإيقاف مكيف هواء السقف

مكيف هواء السقف له وضعان لتكييف الهواء:

- وضع التهوية (☀️)
- وضع التبريد (❄️)

ملاحظة! قبل التبديل من وضع التهوية إلى وضع التبريد أو العكس، انتظر على الأقل 30 ثوان. وإلا فإن تيار التحويل قد يفجر المصهر.



كل وضع له ثلاثة إعدادات:

- منخفض
- متوسط
- مرتفع

للتشغيل، أدر المقيض  إلى وضع التهوية (☀️) أو وضع التبريد (❄️) واختر الإعداد المطلوب.

✓ تشغيل مكيف هواء السقف وتشغيله بالقيَم التي تم ضبطها قبل إيقاف التشغيل.

لإيقاف التشغيل، أدر المقيض  إلى الوضع 0.

#### 9.3.2 ضبط درجة الحرارة

أدر المقيض  إلى الوضع المطلوب. يعني إدارة المقيض في اتجاه عقارب الساعة درجة حرارة أكثر برودة. يتم ضبط درجة الحرارة بمكيف هواء السقف.

### 9.4 مكيفات الهواء على السطح Dometic FJX4233EEH/FJX4333E(EH)/FJX7333IHP/ FJX7337IHP/FJX7457IHP

المعلومات الواردة في هذا الفصل تنطبق فقط على مكيفات هواء السقف FreshJet FJX4233EEH/FJX4333E(EH)/FJX7333IHP/ FJX7337IHP/FJX7457IHP.

### 9.4.1 استخدام جهاز التحكم عن بُعد

- يجب مراعاة التعليمات التالية عند استخدام جهاز التحكم عن بُعد:
- قم بتوجيه جهاز التحكم عن بُعد إلى مستقبل الأشعة تحت الحمراء بلوحة التحكم.
  - يتم إرسال الإعدادات والقيم المعنوية مباشرة إلى مكيف هواء السقف عند الضغط على الزر.
  - يؤكد مكيف هواء السقف استلام البيانات عن طريق صوت صفير.
  - يزيد أو يخفض القيم بشكل أسرع عند الضغط والاستمرار بالضغط على الزر + أو -.
  - في وضع الاستعداد تكون شاشة جهاز التحكم عن بُعد غير نشطة أيضاً. يمكنك تشغيل جهاز التحكم عن بُعد لوضع الاستعداد بشكل مستقل عن مكيف هواء السقف.
- < للتبديل بجهاز التحكم عن بُعد فقط من وإلى وضع الاستعداد، اضغط على الزر (⊕) مع عدم الإشارة إلى مستقبل الأشعة تحت الحمراء بلوحة التحكم IR.

### 9.4.2 تحويل مكيف هواء السقف على وضع التشغيل أو وضع الاستعداد

ملاحظة! عند تشغيل مكيف هواء السقف وتشغيله بالقيم التي تم ضبطها قبل التغيير إلى وضع الاستعداد. لا يمكن إيقاف تشغيل مكيف هواء السقف إلا بقطع مصدر الطاقة.



- < اضغط على الزر (⊕) في جهاز التحكم عن بُعد أو الزر (⊕) بلوحة التحكم لتشغيل مكيف هواء السقف أو الانتقال إلى وضع الاستعداد.

### 9.4.3 اختيار وضع التكييف

- < اختر وضع تكييف الهواء المطلوب باستخدام الزر MODE (أوضاع تكييف الهواء فقط) FJX4233EEH/FJX4333E(EH) بالصفحة 446).
- ✓ يؤكد مكيف هواء السقف استلام القيم بصوت صفير. يتم تحويل مكيف هواء السقف إلى وضع تكييف الهواء المختار.

### 9.4.4 اختيار سرعة المروحة يدوياً

في جميع الأوضاع باستثناء الوضع الأوتوماتيكي (A) ووضع إزالة الرطوبة (⊖)، يمكن اختيار سرعة المروحة يدوياً.

الوصف	رسائل الشاشة
مستوى منخفض للمروحة	
مستوى متوسط للمروحة	
مستوى مرتفع للمروحة.	
أقصى مستوى للمروحة.	
وضع أوتوماتيكي (يتم ضبط سرعة المروحة بناء على درجة الحرارة المحيطة).	

- < اضغط على الزر (A) في جهاز التحكم عن بُعد أو الزر (B) بلوحة التحكم لاختيار سرعة المروحة المطلوبة.  
 ✓ يؤكد مكيف هواء السقف استلام القِيم بصوت صفير.  
 تم ضبط السرعة الجديدة للمروحة.

#### 9.4.5 ضبط درجة الحرارة

- في الوضع الأوتوماتيكي (A)، التبريد (❄️)، التدفئة (☀️)، وإزالة الرطوبة (U)، يمكنك تحديد درجة الحرارة ما بين 16 درجة مئوية و 31 درجة مئوية.  
 < استخدم الزر + و - في جهاز التحكم عن بُعد لضبط درجة الحرارة المطلوبة.  
 ✓ يؤكد مكيف هواء السقف استلام القِيم بملاحظة عالية. يتم ضبط درجة الحرارة بمكيف هواء السقف.

#### 9.4.6 ضبط الوقت الحالي

- يحتاج جهاز التحكم عن بُعد إلى الوقت الحالي لبرمجة المؤقت. يتم عرض الوقت على شاشة جهاز التحكم عن بُعد.  
 1. اضغط واستمر بالضغط على الزر (C) في نموذج الطلب للدخول إلى وضع إعداد الوقت.  
 ✓ يومض الوقت على شاشة جهاز التحكم عن بُعد.  
 2. استخدم الزر + أو - لضبط الوقت الحالي. اضغط واستمر بالضغط على الزر + أو - لمدة أطول من 2 ثوانٍ لزيادة أو تقليل الوقت بشكل أسرع.  
 3. اضغط على الزر SET لتأكيد الوقت.

#### 9.4.7 ضبط المؤقت

- تتيح وظيفة المؤقت ضبط فترة زمنية معينة لتكييف الهواء. يمكنك تحديد وقت التشغيل أو تشغيل وضع الاستعداد أو كلاهما.  
 يتم ضبط وظيفة المؤقت عن طريق جهاز التحكم عن بُعد.

ملاحظة! يعود جهاز التحكم عن بُعد إلى وضعه الأولي إذا لم يتم الضغط على أي زر في جهاز التحكم عن بُعد لمدة 15 ثوانٍ أثناء برمجة المؤقت.



< اضبط مؤقت التشغيل على النحو التالي:

- (a) اختر وضع تكييف الهواء المطلوب وجميع القِيم المطلوبة (على سبيل المثال درجة الحرارة).  
 (b) إذا لزم الأمر، قم بتحويل مكيف هواء السقف إلى وضع الاستعداد.  
 يمكن ضبط مؤقت التشغيل فقط عندما يكون مكيف هواء السقف في وضع الاستعداد.  
 (c) اضغط على الزر (C) مرة واحدة.  
 ✓ يومض الرمز  على شاشة جهاز التحكم عن بُعد.  
 (d) استخدم الزر + أو - لضبط الوقت الذي يجب فيه تشغيل مكيف هواء السقف.  
 (e) اضغط الزر (D).

تم ضبط مؤقت التشغيل. سيتم تشغيل مكيف هواء السقف بالهواء الذي تم اختياره  
 وضع التكييف في الوقت المحدد.

- < اضبط مؤقت وضع الاستعداد على النحو التالي:
- (a) إذا لزم الأمر، قم بتشغيل مكيف هواء السقف.  
يمكن ضبط مؤقت وضع الاستعداد فقط عندما يكون مكيف هواء السقف في وضع التشغيل.
- (b) اضغط على الزر (⊕) مرتين.  
✓ يومض الرمز 8888 على شاشة جهاز التحكم عن بُعد.
- (c) استخدم الزر + أو - لضبط الوقت الذي يجب فيه تحويل مكيف هواء السقف إلى وضع الاستعداد.
- (d) اضغط الزر (⊕).  
تم ضبط مؤقت وضع الاستعداد. يتم تحويل مكيف هواء السقف إلى وضع الاستعداد في الوقت المحدد.  
< اضبط مؤقت وضع التشغيل و مؤقت تشغيل وضع الاستعداد على النحو التالي:  
(a) اختر وضع تكيف الهواء المطلوب وجميع القيم المطلوبة (على سبيل المثال درجة الحرارة).  
(b) اضغط على زر (⊕) ثلاث مرات.  
✓ يتم عرض الرمز 8888 8888 على شاشة جهاز التحكم عن بُعد. يومض الرمز ON للتشغيل.  
(c) استخدم الزر + أو - لضبط الوقت الذي يجب فيه تشغيل مكيف هواء السقف.  
(d) اضغط الزر (⊕).  
✓ يومض الرمز OFF للإيقاف.  
(e) استخدم الزر + أو - لضبط الوقت الذي يجب فيه تحويل مكيف هواء السقف إلى وضع الاستعداد.  
(f) اضغط الزر (⊕).  
✓ تم ضبط أوقات التحويل للتشغيل ولوضع الاستعداد. سيتم تشغيل مكيف هواء السقف خلال الفترة الزمنية المحددة.  
< لإلغاء مؤقت الضبط المسبق، اضغط على الزر (⊕) مرة واحدة.  
✓ الرموز 8888 8888 تخفي. يتم تجاهل القيم المعينة مسبقاً.

## 9.4.8 ضبط وظيفة النوم

- وظيفة النوم متاحة فقط في وضعي التبريد (❄️) أو التدفئة (🔥).
- تعمل وظيفة النوم على الحد من سرعة المروحة إلى مستوى أقل لتقليل مستويات الضوضاء لتسهيل النوم.
- فقط FJX7333IHP/FJX7337IHP/FJX7457IHP: تعمل وظيفة النوم أيضاً على الحد من سرعة المكبس.

- < لتفعيل وظيفة النوم، اتبع ما يلي:
- (a) اضبط درجة الحرارة المطلوبة (ضبط درجة الحرارة بالصفحة 451).
- (b) اضغط على الزر (⊕) في جهاز التحكم عن بُعد أو الزر (⊕) بلوحة التحكم.  
✓ يومض الرمز (⊕) على شاشة جهاز التحكم عن بُعد. تم تفعيل وظيفة النوم.  
< لإيقاف تفعيل وظيفة النوم، اضغط على الزر (⊕) أو (⊖) في جهاز التحكم عن بُعد أو الزر (⊕) بلوحة التحكم.  
✓ يخفي الرمز (⊕) من شاشة جهاز التحكم عن بُعد. تم إيقاف تفعيل وظيفة النوم.

## 9.4.9 تفعيل وظيفة I feel

عندما تكون هذه الوظيفة نشطة، يقيس جهاز التحكم عن بُعد درجة حرارة الغرفة وينقل القياس إلى مكيف هواء السقف كل 10 دقائق. يتكيف مكيف هواء السقف مع القيمة المستهدفة لهذا القياس. يتم تنشيط وظيفة I feel فقط عندما تتراوح درجة الحرارة ما بين 18+ درجة مئوية و 29+ درجة مئوية.

يجب ألا يكون جهاز التحكم عن بُعد موجوداً في منطقة من الغرفة أكثر سخونة أو برودة من الغرفة. على سبيل المثال، لا يجوز تركه في الشمس أو أمام مكيف هواء السقف.

عندما ترتفع درجة الحرارة أكثر من +29 درجة مئوية أو تقل عن +18 درجة مئوية، سيتم إلغاء تنشيط وظيفة feel. l. يومض الرمز  ثلاث مرات على الشاشة ثم ينطفئ.

1. اضغط الزر.

✓ تم تنشيط وظيفة feel. l.

يظهر الرمز  على الشاشة.

2. ضع جهاز التحكم عن بُعد بحيث يشير إلى مستقبل الأشعة تحت الحمراء بلوحة التحكم. خلاف ذلك، لا يمكن إرسال القِيم إلى مكيف هواء السقف.

## 9.4.10 تشغيل الأضواء المحيطة

تنبيه! خطر حدوث إصابات يُحظر بموجب القانون استخدام الأضواء الخارجية أثناء القيادة.



كون الزر  الموجود في جهاز التحكم عن بُعد نشطاً حتى إذا تم إيقاف تشغيل جهاز التحكم عن بُعد.



فقط لـ FreshJet FJX4233EEH/FJX4333E(EH)/FJX7333IHP/FJX7337IHP/FJX7457IHP



< لتشغيل أو إيقاف تشغيل الأضواء الداخلية، اضغط على الزر  الموجود في جهاز التحكم عن بُعد أو بلوحة التحكم.

✓ يومض الزر  مرة واحدة على شاشة جهاز التحكم عن بُعد عند تشغيل الأضواء الداخلية on.

< لتعتيم الأضواء الداخلية قم بما يلي:

(a) اضغط على الزر  الموجود في جهاز التحكم عن بُعد أو بلوحة التحكم لمدة 3 ثوانٍ.

(b) عند الضغط على الزر  في جهاز التحكم عن بُعد؛ اضغط على الزر  لتعتيم الضوء الداخلي بين 50٪ و 100٪.

(c) عند الضغط على الزر  بلوحة التحكم؛ يتراوح سطوع الضوء الداخلي بين 50٪ و 100٪. اترك الزر  عند الوصول إلى السطوع المطلوب.

فقط FreshJet FJX7333IHP/FJX7337IHP/FJX7457IHP

< لتشغيل الأضواء الخارجية أو إيقاف تشغيلها، اضغط على الزر  الموجود بلوحة التحكم.

## 9.4.11 استبدال بطاريات جهاز التحكم عن بُعد

ملاحظة! قد تظل شاشة جهاز التحكم عن بُعد ساطعة حتى إذا كانت البطاريات منخفضة. استبدل البطاريات عندما يشير جهاز التحكم عن بُعد إلى انخفاض البطاريات.



< استبدل البطاريات كما هو موضح.

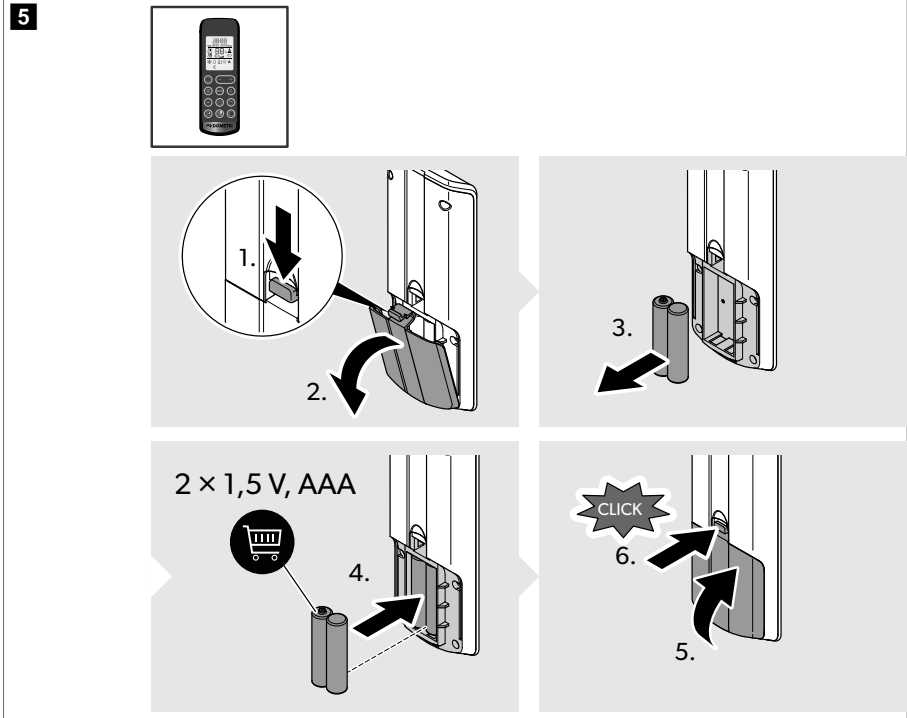

✓ تعرض الشاشة جميع الرموز 5 ثوان.

حماية البيئة! البطاريات والمراكم لا تنتمي للنفايات المنزلية. يُرجى إرسال البطاريات المستهلكة والمراكم التالفة إلى التاجر أو إلى أحد مراكز التجميع.



## 9.5 تنظيم إمداد الهواء داخل السيارة

يمكن ضبط تدفق الهواء على طول السقف أو نحو الأرض.

< اقلب الشرائح الموجودة في فتحات الهواء بشكل مستقل في الاتجاهات المطلوبة.

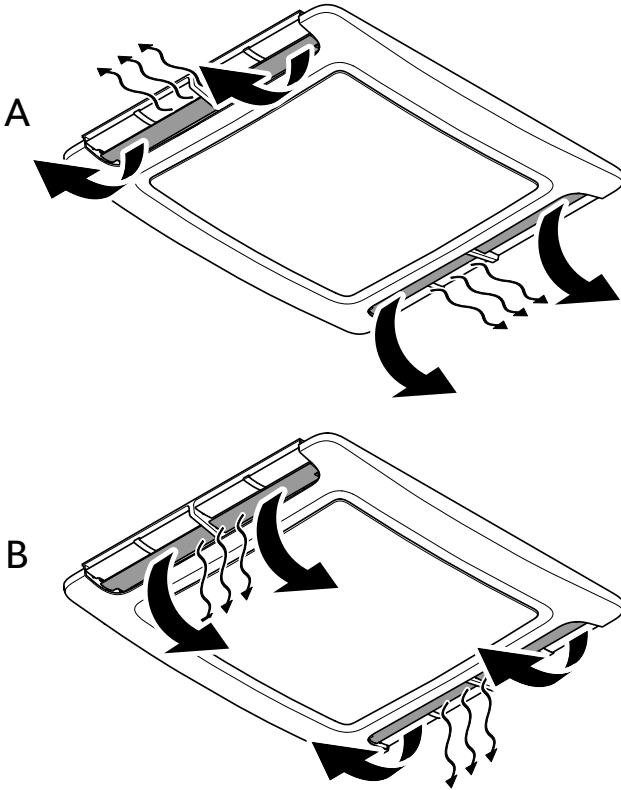
**6**

## 10 تنظيف مكيف هواء السقف

تحذير! خطر التلف



- لا تستخدم أي وسيلة بخلاف تلك الموصى بها من قبل الشركة المصنعة لتسريع عملية إزالة الجليد أو للتنظيف.
- لا تقم بتنظيف وحدة تكييف الهواء بالسقف بمنظف يعمل بالضغط العالي. قد يؤدي دخول الماء إلى تلف وحدة تكييف الهواء.
- لا تستخدم للتنظيف أشياء حادة أو صلبة أو مواد تنظيف قوية لأنها قد تلحق أضراراً بمكيف هواء السقف.
- لا تستخدم البنزين أو الديزل أو المواد المذيبة.

1. قم بإزالة الأوراق وأي أساخ أخرى بانتظام من مكان سحب الهواء وشبكات التهوية لمكيف هواء السقف. لا تتلف شبكات التهوية أثناء العملية.

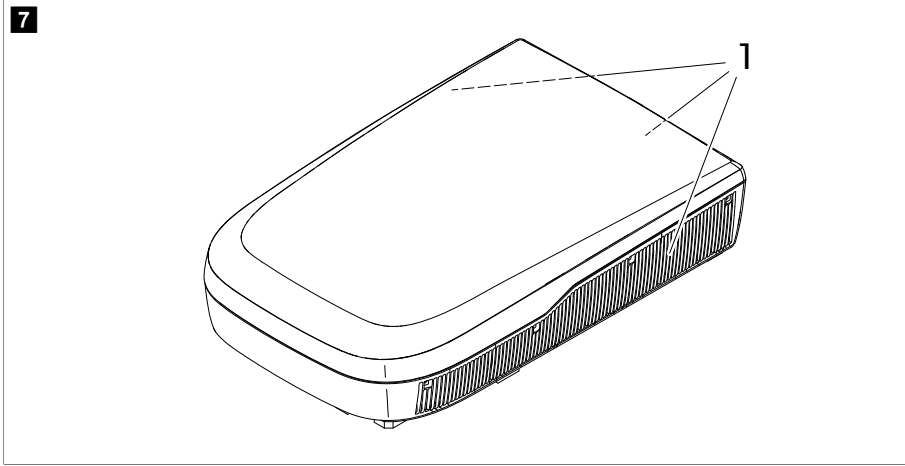

2. قم أحياناً بتنظيف العلب الخاصة بالوحدة العلوية على السطح وصندوق توزيع الهواء بقطعة قماش مبللة. استخدم فقط الماء مع مادة تنظيف لطيفة.
3. فقط لـ FreshJet FJX4233EEH/FJX4333E(EH)/FJX7333IHP/FJX7337IHP/FJX7457IHP: قم بتنظيف جهاز التحكم عن بُعد من حين لآخر بقطعة قماش مبللة قليلاً. نظّف الشاشة بقطعة قماش لتنظيف النظارات.
4. فقط FreshJet FJX4233EEH/FJX4333E(EH)/FJX7333IHP/FJX7337IHP/FJX7457IHP: قم بتنظيف شاشة صندوق توزيع الهواء من حين لآخر بمحلول لطيف من الماء الدافئ والصابون. شاشة العرض مصنوعة من مادة الأكرليك ويمكن أن تتلف بسبب بعض المواد الكيميائية المنزلية الشائعة مثل المنظفات الكيميائية ومنظفات النوافذ والكحول وبعض عوامل التوتر والمذيبات العضوية والمنعمات.

## 11 الصيانة

تنبيه! خطر حدوث إصابات لا يجوز إجراء أي أعمال صيانة أخرى بالإضافة إلى الموضوعات الموضحة هنا إلا من قبل عمال مؤهلين وعلى دراية بالمخاطر التي ينطوي عليها التعامل مع أنظمة التبريد وأنظمة تكييف الهواء وكذلك اللوائح ذات الصلة.





## فترات

## الفحص/الصيانة

تحقق مما إذا كانت قنوات تصريف مياه التكتيف (1) الموجودة على جانبي مكيف الهواء بالسقف نظيفة وأن مياه التكتيف قادرة على الخروج.

بشكل دوري

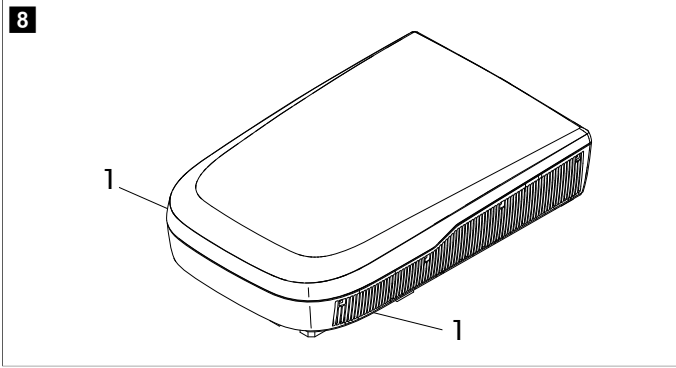

تنظيف الفلتر في وحدة تصريف الهواء.

بشكل دوري (FreshJet)  
(FJX4233M)

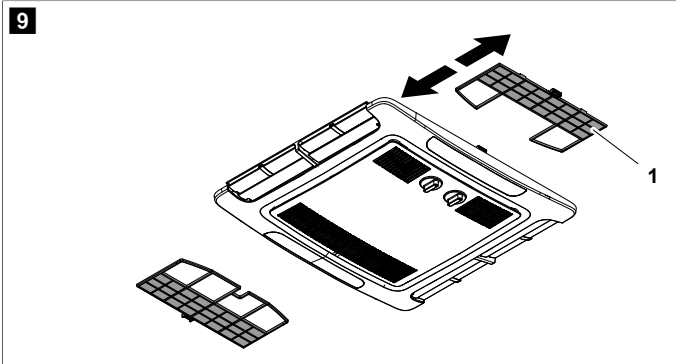

1. قم بإزالة الفلتر (1).
2. قم بتنظيف الفلتر (1) بمحلول تنظيف واتركه حتى يجف.
3. قم بإعادة تركيب الفلتر الجاف (1).

## فترات

## الفحص/الصيانة

- تنظيف الفلتر في وحدة تصريف الهواء.

بشكل دوري (FreshJet)  
FJX4233EEH/  
FJX4333E(EH)/  
FJX7333IHP/  
FJX7337IHP/  
(FJX7457IHP)

10

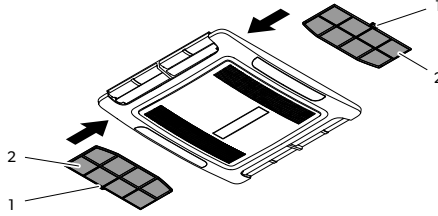

1. أدخل مفك براغي أو مسكين في المقبض (1) لسحب الفلترات (2) للخارج قليلاً.
2. قم بإزالة الفلتر باليد.
3. قم بتنظيف الفلتر بمحلول تنظيف واتركه حتى يجف.
4. قم بإعادة إدخال الفلتر الجاف في شكل 10 بالصفحة 458.

- يجب صيانة المبادل الحراري لمكيف هواء السفق من قبل شركة متخصصة.
- افحص وسائل الإحكام الموجودة بين مكيف هواء السفق وسقف السيارة بحثاً عن شقوق وأضرار أخرى.
- تحقق مما إذا كانت براغي التثبيت مشدودة إلى عزم الدوران الصحيح (2.5 نيوتن متر  $\pm$  0.3 نيوتن متر) واضبطها إذا لزم الأمر.

مرة كل عام

## 12 Troubleshooting

المشكلة	السبب المحتمل	الحل
لا يحدث التبريد بشكل جيد	مكيف هواء السفق غير مضبوط على وضع التبريد.	اضبط مكيف هواء السفق على وضع التبريد.
	درجة الحرارة المحيطة أعلى من 52 درجة مئوية.	تم تصميم مكيف هواء السفق للتبريد فقط حتى درجات حرارة محيطة تصل إلى 52 درجة مئوية.
	درجة الحرارة التي تم ضبطها أعلى من درجة حرارة الغرفة.	اختر درجة حرارة أقل.
	درجة الحرارة المحيطة أقل من 16 درجة مئوية.	تم تصميم مكيف هواء السفق للتبريد فقط في درجات حرارة محيطة أعلى من 16 درجة مئوية.
	أحد مستشعرات درجة الحرارة تالف.	اتصل بوكيل خدمة معتمد أو بشركة Dometic.
	مروحة المبخر تالفة.	اتصل بوكيل خدمة معتمد أو بشركة Dometic.
	مروحة المكثف تالفة.	اتصل بوكيل خدمة معتمد أو بشركة Dometic.
فقط لـ FreshJet FJX4233EEH/ FJX4333E(EH)/FJX7333IHP/ FJX7337IHP/FJX7457IHP: لا تحدث التدفئة بشكل جيد	مكيف هواء السفق غير مضبوط على وضع التدفئة.	اضبط مكيف هواء السفق على وضع التدفئة.

المشكلة	السبب المحتمل	الحل
	درجة الحرارة المحيطة أقل من - 2 درجة مئوية.	تم تصميم مكيف هواء السقف لدرجات حرارة محيطية أعلى من - 2 درجة مئوية.
	درجة الحرارة التي تم ضبطها أقل من درجة حرارة الغرفة.	اختر درجة حرارة أعلى.
	أحد مستشعرات درجة الحرارة تالف.	اتصل بوكيل خدمة معتمد أو بشركة Dometic.
	مروحة المبخز تالفة.	اتصل بوكيل خدمة معتمد أو بشركة Dometic.
انخفاض إنتاج الهواء	فتحات سحب الهواء مسدودة أو مغطاة.	أزل الأوراق وغيرها من الأوساخ من شبكات تهوية مكيف هواء السقف.
	وحدة المروحة تالفة.	اتصل بوكيل خدمة معتمد أو بشركة Dometic.
دخول الماء إلى السيارة.	فتحات تصريف مياه التكثيف مسدودة.	قم بتنظيف فتحات تصريف المياه من مياه التكثيف.
	موانع التسرب تالفة.	اتصل بوكيل خدمة معتمد أو بشركة Dometic.
مكيف هواء السقف لا يعمل.	لا يوجد مصدر طاقة متصل.	تحقق من التيار الكهربائي.
	الجهد منخفض جداً (> 200 فولت).	اتصل بوكيل خدمة معتمد أو بشركة Dometic.
	محول الجهد تالف.	اتصل بوكيل خدمة معتمد أو بشركة Dometic.
	أحد مستشعرات درجة الحرارة تالف.	اتصل بوكيل خدمة معتمد أو بشركة Dometic.
	المصهر الكهربائي لمصدر الطاقة منخفض للغاية.	اتصل بوكيل خدمة معتمد أو بشركة Dometic.
مكيف هواء السقف لا ينطق.	أحد مستشعرات درجة الحرارة تالف.	اتصل بوكيل خدمة معتمد أو بشركة Dometic.
	المصهر الكهربائي لمصدر الطاقة منخفض للغاية.	اتصل بوكيل خدمة معتمد أو بشركة Dometic.
	تعطل مستشعر التبريد.	درجة الحرارة الخارجية منخفضة جداً أو أن جميع فتحات الهواء مغلقة.
		<b>فقط لـ FreshJet FJX4233EEH/ FJX4333E(EH)/FJX7333IHP/ مكيف هواء FJX7337IHP/FJX7457IHP</b> السقف يعلق نفسه باستمرار.
تعرض الشاشة: P0	زيادة درجة الحرارة أو زيادة التيار على وحدة IPM	اتصل بوكيل خدمة معتمد أو بشركة Dometic.
تعرض الشاشة: P1	حماية تحت الجهد	اتصل بوكيل خدمة معتمد أو بشركة Dometic.
تعرض الشاشة: P2	حماية وحدة التيار المتردد الزائد	اتصل بوكيل خدمة معتمد أو بشركة Dometic.
تعرض الشاشة: P4	حماية أنبوب التفريغ من الحرارة الزائدة	اتصل بوكيل خدمة معتمد أو بشركة Dometic.
تعرض الشاشة: P5	حماية ملف المبخز (وضع التبريد)	اتصل بوكيل خدمة معتمد أو بشركة Dometic.
تعرض الشاشة: P6	حماية ملف المكثف (وضع التبريد)	اتصل بوكيل خدمة معتمد أو بشركة Dometic.
تعرض الشاشة: P7	حماية ملف المبخز (وضع التسخين)	اتصل بوكيل خدمة معتمد أو بشركة Dometic.
تعرض الشاشة: P9	محرك المكبس غير عادي أو المكبس لا يبدأ بالتشغيل	اتصل بوكيل خدمة معتمد أو بشركة Dometic.
تعرض الشاشة: E0	خطأ بالاتصال	اتصل بوكيل خدمة معتمد أو بشركة Dometic.

المشكلة	السبب المحتمل	الحل
E1	خطأ في مستشعر درجة حرارة الغرفة	اتصل بوكيل خدمة معتمد أو بشركة Dometic.
E2	خطأ في مستشعر درجة حرارة ملف المبخر	اتصل بوكيل خدمة معتمد أو بشركة Dometic.
E3	خطأ في مستشعر درجة حرارة ملف المكثف	اتصل بوكيل خدمة معتمد أو بشركة Dometic.
E7	خطأ في مستشعر درجة الحرارة الخارجية	اتصل بوكيل خدمة معتمد أو بشركة Dometic.
E8	يجب تفريغ أنبوب مستشعر درجة حرارة أنبوب التصريف	اتصل بوكيل خدمة معتمد أو بشركة Dometic.
E9	خطأ في محرك المكبس و وحدة IPM	اتصل بوكيل خدمة معتمد أو بشركة Dometic.
EA	خطأ في المستشعر الحالي	اتصل بوكيل خدمة معتمد أو بشركة Dometic.
EE	خطأ EEPROM خارجي	اتصل بوكيل خدمة معتمد أو بشركة Dometic.
EL	خطأ في اتصال LIN-BUS/CI-BUS	اتصل بوكيل خدمة معتمد أو بشركة Dometic.

## 13 التخلص من الجهاز

ضع مواد التعبئة والتغليف في الصناديق المناسبة الخاصة بالنفايات القابلة لإعادة التدوير كلما أمكن ذلك. استشر مركز محلي لإعادة التدوير أو تاجر متخصص للحصول على تفاصيل حول كيفية التخلص من المنتج وفقاً للوائح التخلص المطبقة.



حماية البيئة! البطاريات والمراكم لا تنتمي للنفايات المنزلية. يرجى إرسال البطاريات المستهلكة والمراكم التالفة إلى التاجر أو إلى أحد مراكز التجميع.



## 14 الضمان

يتم تطبيق فترة الضمان القانونية. إذا كان المنتج معيباً، فيرجى الاتصال بفرع الشركة المصنعة في بلدك (انظر [dometic.com/dealer](http://dometic.com/dealer)) أو بائع التجزئة الذي تعامل معه.

لتنفيذ إجراءات الإصلاح والضمان، يجب إرفاق المستندات التالية مع الجهاز:

- نسخة من الفاتورة مع تاريخ الشراء
  - سبب الشكوى أو وصف للعتل
- عليك الحذر من أن الإصلاح الذاتي أو غير الاحترافي قد يؤدي إلى عواقب تتعلق بالسلامة وإلغاء الضمان.

11

FreshJet FJX4233M

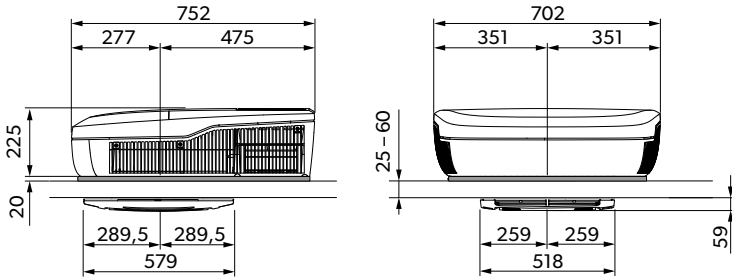

12

FJX4233EEH, FJX4333E(EH), FJX7333IHP

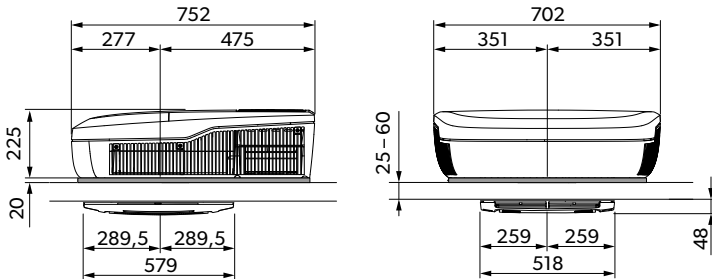

13

FreshJet FJX7337IHP

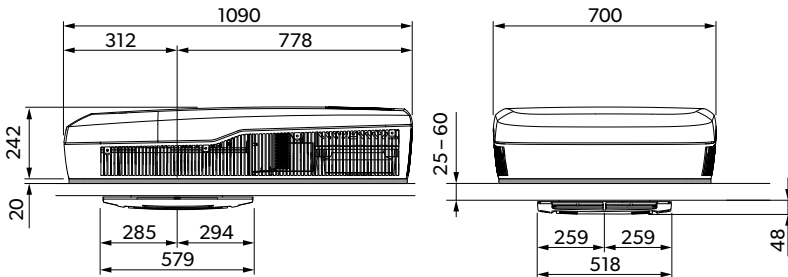

14

## FreshJet FJX7457IHP

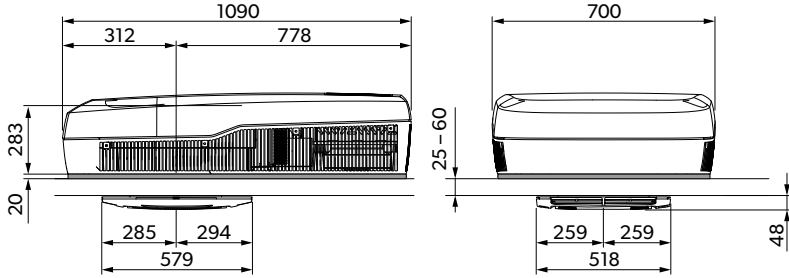

يحتوي على غازات دفيئة مفلورة. معدات محكمة الغلق.

FreshJet FJX4233M	
1500 وات	قدرة التبريد على أساس ISO 5151:
220 فولت ... 240 فولت / 50 هرتز	جهد دخل التيار المتردد:
> 3.3 أمبير	التبريد الحالي المقدر:
4 أمبير	المصهر المطلوب:
- 2 درجة مئوية ... 52 درجة مئوية	نطاق درجة حرارة التشغيل:
R410a	مادة التبريد:
380 غ	كمية المبرد:
0.793 طن	CO <sub>2</sub> يعادل:
2088	احتمالية حدوث احتباس حراري (GWP):
IPX4	فئة الحماية (وحدة السقف العلوي):
> 70 ديسيبل (أ)	مستوى الضوضاء (أعلى إعداد للمروحة)
> 5 م	الحد الأقصى لطول الشاحنة المقترح (مزودة بجدران معزولة):
شكل 11 بالصفحة 461	أبعاد الطول x العرض x الارتفاع:
> 30 كجم	الوزن:
UK CA CE	الفحص/الشهادة:

FreshJet FJX4333E	FreshJet FJX4333EEH	FreshJet FJX4233EEH	
وات 2200	وات 2200	وات 1700	قدرة التبريد على أساس ISO 5151:
-	وات 1000	وات 800	قدرة التدفئة على أساس ISO 5151:
220 فولت ... 240 فولت / 50 هرتز			جهد دخل التيار المتردد:
4.8 أمبير	4.8 أمبير	3.6 أمبير	التبريد الحالي المقدر:
-	> 5.2 أمبير	> 5.2 أمبير	التدفئة الحالية المقدرة:
6 أمبير	5 أمبير	4 أمبير	المصهر المطلوب:
- 2 درجة مئوية ... 52 درجة مئوية			نطاق درجة حرارة التشغيل:
R32			مادة التبريد:
غ 360	غ 360	غ 320	كمية المبرد:
0.243 طن	0.243 طن	0.216 طن	CO <sub>2</sub> يعادل:
675			احتمالية حدوث احتباس حراري (GWP):
IPX4			فئة الحماية (وحدة السقف العلوي):
> 70 ديسيبل (أ)			مستوى الضوضاء (أعلى إعداد للمروحة)
> 7 م	> 7 م	> 6 م	الحد الأقصى لطول الشاحنة المقترح (مزودة بجدران معزولة):
شكل 12 بالصفحة 461			أبعاد الطول X العرض X الارتفاع:
> 30 كجم	> 30 كجم	> 30 كجم	الوزن:
UK CA CE			الفحص/الشهادة:

FreshJet FJX7457IHP	FreshJet FJX7337IHP	FreshJet FJX7333IHP	
وات 3500	وات 3000	وات 2200	قدرة التبريد على أساس ISO 5151:
وات 3000	وات 2500	وات 2000	قدرة التدفئة على أساس ISO 5151:
220 فولت ... 240 فولت / 50 هرتز ... 60 هرتز	220 فولت ... 240 فولت / 50 هرتز ... 60 هرتز	220 فولت ... 240 فولت / 50 هرتز ... 60 هرتز	جهد دخل التيار المتردد:
> 7.5 أمبير	> 7.5 أمبير	> 7.5 أمبير	التبريد الحالي المقدر:
> 6.1 أمبير	> 6.1 أمبير	> 6.1 أمبير	التدفئة الحالية المقدرة:
6 أمبير	6 أمبير	6 أمبير	المصهر المطلوب:

FreshJet FJX7457IHP	FreshJet FJX7337IHP	FreshJet FJX7333IHP	
منوية ... 52 درجة منوية - 2 درجة	منوية ... 52 درجة منوية - 2 درجة منوية	منوية ... 52 درجة منوية - 2 درجة	نطاق درجة حرارة التشغيل:
R32	R32	R32	مادة التبريد:
غ 650	غ 480	غ 420	كمية المبرد:
طن 0.43875	طن 0.3240	طن 0.2835	CO <sub>2</sub> يعادل:
675			احتمالية حدوث احتباس حراري (GWP):
IPX4			فئة الحماية (وحدة السقف العلوي):
> 70 ديسيبل (أ)			مستوى الضوضاء (أعلى إعداد للمروحة)
< 8 م	> 7 م	> 7 م	الحد الأقصى لطول الشاحنة المقترح (مزودة بجدران معزولة):
شكل 14 بالصفحة 462	شكل 13 بالصفحة 461	شكل 12 بالصفحة 461	أبعاد الطول X العرض X الارتفاع:
> 40 كجم	> 35 كجم	> 30 كجم	الوزن:
			الفحص/الشهادة:





**dometic.com**

---

**YOUR LOCAL  
DEALER**

**[dometic.com/dealer](https://dometic.com/dealer)**

**YOUR LOCAL  
SUPPORT**

**[dometic.com/contact](https://dometic.com/contact)**

**YOUR LOCAL  
SALES OFFICE**

**[dometic.com/sales-offices](https://dometic.com/sales-offices)**

---